

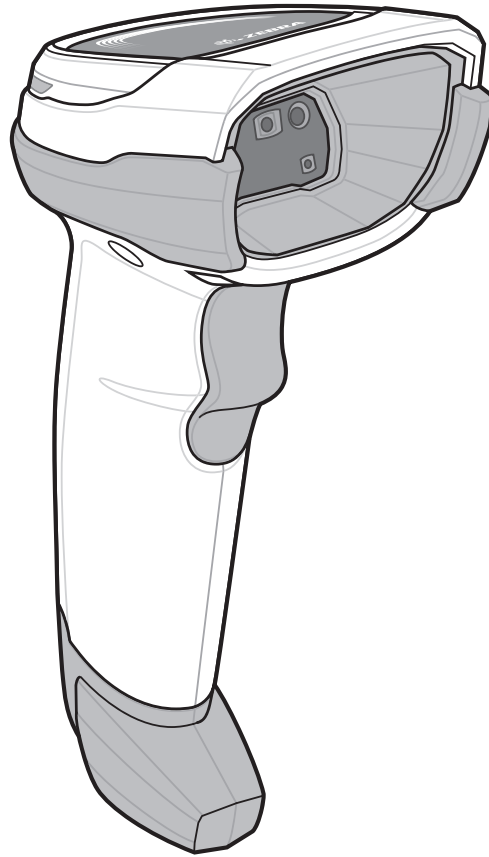

DS8108



Digital Scanner

Product Reference Guide



DS8108 DIGITAL SCANNER PRODUCT REFERENCE GUIDE

MN-002926-08EN

Revision A

March 2023

ZEBRA and the stylized Zebra head are trademarks of Zebra Technologies Corporation, registered in many jurisdictions worldwide. All other trademarks are the property of their respective owners. ©2023 Zebra Technologies Corporation and/or its affiliates. All rights reserved.

Information in this document is subject to change without notice. The software described in this document is furnished under a license agreement or nondisclosure agreement. The software may be used or copied only in accordance with the terms of those agreements.

For further information regarding legal and proprietary statements, please go to:

SOFTWARE: zebra.com/linkoslegal

COPYRIGHTS: zebra.com/copyright

PATENTS: ip.zebra.com

WARRANTY: zebra.com/warranty

END USER LICENSE AGREEMENT: zebra.com/eula

Terms of Use

Proprietary Statement

This manual contains proprietary information of Zebra Technologies Corporation and its subsidiaries (“Zebra Technologies”). It is intended solely for the information and use of parties operating and maintaining the equipment described herein. Such proprietary information may not be used, reproduced, or disclosed to any other parties for any other purpose without the express, written permission of Zebra Technologies.

Product Improvements

Continuous improvement of products is a policy of Zebra Technologies. All specifications and designs are subject to change without notice.

Liability Disclaimer

Zebra Technologies takes steps to ensure that its published Engineering specifications and manuals are correct; however, errors do occur. Zebra Technologies reserves the right to correct any such errors and disclaims liability resulting therefrom.

Limitation of Liability

In no event shall Zebra Technologies or anyone else involved in the creation, production, or delivery of the accompanying product (including hardware and software) be liable for any damages whatsoever (including, without limitation, consequential damages including loss of business profits, business interruption, or loss of business information) arising out of the use of, the results of use of, or inability to use such product, even if Zebra Technologies has been advised of the possibility of such damages. Some jurisdictions do not allow the exclusion or limitation of incidental or consequential damages, so the above limitation or exclusion may not apply to you.

Revision History

Changes to the original guide are listed below:

Change	Date	Description
MN-002926-01 Rev A	03/2017	Initial Release
MN-002926-02 Rev A	3/2018	<p>Updates:</p> <ul style="list-style-type: none"> - Unsolicited Heartbeat Interval heartbeat event digit sequence number changed to 4 digits. - Signature Capture Width minimum changed to 016. - Signature Capture Height minimum changed to 016. - Document Capture Stand part number. - Zebra copyright statement. - 123Scan chapter. - OCR parameters 1766 & 1770. - Digimarc barcodes and description; add to Appendix A default table. - Defaults for ISBT. - First row of table under Hands-free Decode Session Timeout. - Values below barcodes for SSI baud rates: 230,400, 460,800, 921,600. - Changed RSS Expanded to GS1 DataBar Expanded (Digimarc chapter). - Changed ISBT 128 default to enable. - Changed KT8108-DC-STND to STND-DC1081C-04. <p>Deletes:</p> <ul style="list-style-type: none"> - Charging temperature under User Environment (Tech Specs). - Timeout to Low Power Mode from Auto Aim parameter <p>Adds:</p> <ul style="list-style-type: none"> - Note when enabling ISBT Concatenation or Autodiscriminate ISBT Concatenation. - Grid Matrix parameters. - Symbol I, AIM ID, and AIM Code Modifier Character for Grid Matrix. - OCR parameter: OCR Redundancy. - GS1 DataBar variants. - New sample barcodes. - New Microsoft UWP USB Host Type (name changed to USB HID POS). - Driver's License Parsing parameter number - Scan Speed Analytics appendix. - Secure Pharmaceutical Decoding. - Codabar Security Level. - USB Certification logo. - Grid Matrix sample barcode. - JIRA issues.

Change	Date	Description
MN-002926-03 Rev A	6/2019	<p>Removed:</p> <ul style="list-style-type: none"> - Simple Com Port Emulation. - Require and Suppress from OCR Template. <p>Added:</p> <ul style="list-style-type: none"> - JPEG Quality (1909) and Video JPEG Quality or Size Option (1910) - TGCS (IBM) USB Direct I/O Beep (parameter # 1360) - DotCode parameters - ISBT Autodiscriminate note - USB CDC Host Variant <p>Updated:</p> <ul style="list-style-type: none"> - Secure Pharmaceutical to securPharm - OCR Quiet Zone and OCR Check Digit Modulus numeric keypad links - MSI Check Digits - OCR template default and text
MN-002926-04 Rev A	1/2020	Updated CDC ARINC barcode.
MN-002926-05EN Rev A	7/2020	<ul style="list-style-type: none"> - Split 123Scan chapter to Chapter 2 123Scan and Software Tools and Chapter 16 Data Formatting: ADF, MDF, Preferred Symbol, Data Parsing - Updated Chapter 2 123Scan Requirements - Updated the cleaners and disinfectant cleaners lists - Updated Scanner SDK, Other Software Tools, and Videos - Added the USB Cert information in Table 4-2 - Added Data Parsing in Chapter 16 - Added Electronic Article Surveillance (EAS) - Added Linked QR Mode (parameter #1847).
MN-002926-06EN Rev A	4/2021	<p>Added:</p> <ul style="list-style-type: none"> - Datalogic Host Format - Datalogic Supported Commands - Datalogic RS232 variant to Table 7-2 and Table 7-3 - Datalogic USB CDC Host Variant barcode - RS322 Host Datalogic Variant - Night Mode Silence Parameter Programming Beeper Indications. <p>Removed:</p> <ul style="list-style-type: none"> - Provide Documentation Feedback - "https://www". <p>Updated the Data Parsing section.</p>
MN-002926-07EN Rev A	9/2021	Updated USB CDC Host Variant.
MN-002926-08EN Rev A	3/2023	<ul style="list-style-type: none"> - Added LED on Good Decode (parameter # 744) - Update User Preferences Parameter Defaults Table 10-1, and Appendix A Standard Parameter Defaults Table A-1 on the page references for Direct Decode Indicator (parameter # 859)

TABLE OF CONTENTS

Revision History	iii
------------------------	-----

About This Guide

Introduction	xxi
Configurations	xxi
Related Product Line Configurations/Accessories	xxii
Cables	xxii
Chapter Descriptions	xxii
Notational Conventions	xxiv
Related Documents and Software	xxiv
Service Information	xxv

Chapter 1: Getting Started

Introduction	1-1
Interfaces	1-2
Unpacking	1-2
Setting Up the Digital Scanner	1-3
Installing the Interface Cable	1-3
Removing the Interface Cable	1-4
Connecting Power (if required)	1-4
Configuring the Digital Scanner	1-4

Chapter 2: 123Scan and Software Tools

Introduction	2-1
123Scan	2-1
Communication with 123Scan	2-2
123Scan Requirements	2-2
123Scan Information	2-2
Scanner SDK, Other Software Tools, and Videos	2-3
Scanner Control App	2-4

Chapter 3: Data Capture

Introduction	3-1
Beeper and LED Indicators	3-2
Scanning	3-4
Scanning in Presentation (Hands-free) Mode	3-4
Scanning in Hand-held Mode	3-7
Aiming	3-7
Decode Ranges	3-9
DS8108-SR/DL Configurations	3-9
DS8108-HC Configurations	3-10
Assembling the Document Capture Stand	3-11
Assembly	3-12
Electronic Article Surveillance (EAS)	3-14
Installing	3-15

Chapter 4: Maintenance, Troubleshooting, & Technical Specifications

Introduction	4-1
Maintenance	4-1
Known Harmful Ingredients	4-2
Approved Cleaners for Standard DS8108 Digital Scanners	4-2
Approved Disinfectant Cleaners for Healthcare Configurations of the DS8108 Digital Scanners ..	4-2
Cleaning the Digital Scanner	4-3
Troubleshooting	4-5
Dump Scanner Parameters	4-7
Send Versions	4-8
Technical Specifications	4-9
Digital Scanner Signal Descriptions	4-12

Chapter 5: USB Interface

Introduction	5-1
Setting Parameters	5-1
Scanning Sequence Examples	5-1
Errors While Scanning	5-2
Connecting a USB Interface	5-2
USB Parameter Defaults	5-4
USB Host Parameters	5-6
USB Device Type	5-6
Symbol Native API (SNAPI) Status Handshaking	5-8
USB Keystroke Delay	5-8
USB Caps Lock Override	5-9
Bar Codes with Unknown Characters	5-9
USB Convert Unknown to Code 39	5-10
USB Fast HID	5-11
USB Polling Interval	5-12
Keypad Emulation	5-14
Quick Keypad Emulation	5-14
Keypad Emulation with Leading Zero	5-15

USB Keyboard FN1 Substitution	5-15
Function Key Mapping	5-16
Simulated Caps Lock	5-16
Convert Case	5-17
USB Static CDC	5-17
USB CDC Host Variant	5-18
TGCS (IBM) USB Direct I/O Beep	5-21
TGCS (IBM) USB Bar Code Configuration Directive	5-22
TGCS (IBM) USB Specification Version	5-22
ASCII Character Sets	5-23

Chapter 6: SSI Interface

Introduction	6-1
Communication	6-1
SSI Commands	6-2
SSI Transactions	6-3
General Data Transactions	6-3
Decoded Data Transmission	6-4
Communication Summary	6-5
RTS/CTS Lines	6-5
ACK/NAK Option	6-5
Number of Data Bits	6-5
Serial Response Timeout	6-6
Retries	6-6
Baud Rate, Stop Bits, Parity, Response Timeout, ACK/NAK Handshaking	6-6
Errors	6-6
SSI Communication Notes	6-6
Using Time Delay to Low Power Mode with SSI	6-7
Encapsulation of RSM Commands/Responses over SSI	6-8
Command Structure	6-8
Response Structure	6-8
Example Transaction	6-9
Setting Parameters	6-10
Scanning Sequence Examples	6-10
Errors While Scanning	6-10
Simple Serial Interface Parameter Defaults	6-11
SSI Host Parameters	6-12
Select SSI Host	6-12
Baud Rate	6-12
Parity	6-13
Check Parity	6-14
Stop Bits	6-15
Software Handshaking	6-16
Host RTS Line State	6-17
Decode Data Packet Format	6-17
Host Serial Response Timeout	6-18
Host Character Timeout	6-19
Multipacket Option	6-20
Interpacket Delay	6-21

Event Reporting	6-22
Decode Event	6-22
Boot Up Event	6-23
Parameter Event	6-23

Chapter 7: RS-232 Interface

Introduction	7-1
Setting Parameters	7-1
Scanning Sequence Examples	7-2
Errors While Scanning	7-2
Connecting an RS-232 Interface	7-2
RS-232 Parameter Defaults	7-3
RS-232 Host Parameters	7-4
RS-232 Host Types	7-7
Baud Rate	7-9
Parity	7-10
Stop Bits	7-11
Data Bits	7-11
Check Receive Errors	7-12
Hardware Handshaking	7-12
Software Handshaking	7-14
Host Serial Response Timeout	7-16
RTS Line State	7-17
Beep on <BEL>	7-17
Intercharacter Delay	7-18
Nixdorf Beep/LED Options	7-19
Bar Codes with Unknown Characters	7-19
Datalogic Host Format	7-20
Datalogic Supported Commands	7-20
ASCII Character Sets	7-21

Chapter 8: IBM 468X / 469X Interface

Introduction	8-1
Setting Parameters	8-1
Scanning Sequence Examples	8-1
Errors While Scanning	8-2
Connecting an IBM 468X/469X Host	8-2
IBM Parameter Defaults	8-3
IBM Host Parameters	8-4
Port Address	8-4
Convert Unknown to Code 39	8-5
RS-485 Beep Directive	8-5
RS-485 Bar Code Configuration Directive	8-6
IBM-485 Specification Version	8-6

Chapter 9: Keyboard Wedge Interface

Introduction	9-1
--------------------	-----

Setting Parameters	9-1
Scanning Sequence Examples	9-1
Errors While Scanning	9-2
Connecting a Keyboard Wedge Interface	9-2
Keyboard Wedge Parameter Defaults	9-3
Keyboard Wedge Host Parameters	9-4
Keyboard Wedge Host Types	9-4
Bar Codes with Unknown Characters	9-4
Keystroke Delay	9-5
Intra-keystroke Delay	9-5
Alternate Numeric Keypad Emulation	9-6
Quick Keypad Emulation	9-6
Simulated Caps Lock	9-7
Caps Lock Override	9-7
Convert Case	9-8
Function Key Mapping	9-8
FN1 Substitution	9-9
Send Make and Break	9-9
Keyboard Map	9-10
ASCII Character Sets	9-10

Chapter 10: User Preferences & Miscellaneous Options

Introduction	10-1
Setting Parameters	10-1
Scanning Sequence Examples	10-2
Errors While Scanning	10-2
User Preferences/Miscellaneous Options Parameter Defaults	10-2
User Preferences	10-5
Default Parameters	10-5
Parameter Bar Code Scanning	10-6
Beep After Good Decode	10-6
Beeper Volume	10-7
Beeper Tone	10-8
Beeper Duration	10-9
Suppress Power Up Beeps	10-10
LED on Good Decode	10-10
Direct Decode Indicator	10-11
Decode Pager Motor (DS8108-HC Only)	10-12
Decode Pager Motor Duration (DS8108-HC Only)	10-13
Night Mode (DS8108-HC Only)	10-14
Low Power Mode	10-18
Hand-held Trigger Mode	10-21
Hands-free Mode	10-22
Hand-held Decode Aiming Pattern	10-23
Presentation (Hands-free) Decode Aiming Pattern	10-24
Picklist Mode	10-25
Continuous Bar Code Read	10-26
Unique Bar Code Reporting	10-26

Decode Session Timeout	10-27
Hands-free Decode Session Timeout	10-27
Timeout Between Decodes, Same Symbol	10-28
Timeout Between Decodes, Different Symbols	10-28
Triggered Timeout, Same Symbol	10-29
Mobile Phone/Display Mode	10-30
PDF Prioritization	10-31
PDF Prioritization Timeout	10-31
Presentation (Hands-free) Mode Field of View	10-32
Decoding Illumination	10-32
Illumination Brightness	10-33
Motion Tolerance (Hand-held Trigger Modes Only)	10-34
Miscellaneous Scanner Parameters	10-34
Enter Key	10-34
Tab Key	10-34
Transmit Code ID Character	10-35
Prefix/Suffix Values	10-36
Scan Data Transmission Format	10-37
FN1 Substitution Values	10-39
Transmit "No Read" Message	10-40
Unsolicited Heartbeat Interval	10-41
securPharm Decoding	10-42
securPharm Output Formatting	10-43

Chapter 11: Image Capture Preferences

Introduction	11-1
Setting Parameters	11-1
Scanning Sequence Examples	11-2
Errors While Scanning	11-2
Image Capture Preferences Parameter Defaults	11-2
Image Capture Preferences	11-4
Operational Modes	11-4
Image Capture Illumination	11-5
Image Capture Autoexposure	11-5
Fixed Exposure	11-6
Fixed Gain	11-6
Gain/Exposure Priority for Snapshot Mode	11-7
Snapshot Mode Timeout	11-8
Snapshot Aiming Pattern	11-9
Silence Operational Mode Changes	11-9
Image Cropping	11-10
Crop to Pixel Addresses	11-10
Image Size (Number of Pixels)	11-12
Image Brightness (Target White)	11-13
JPEG Image Options	11-13
JPEG Quality Value	11-14
JPEG Size Value	11-14
Image Enhancement	11-15
Image File Format Selector	11-16

Image Rotation	11-17
Bits Per Pixel	11-18
Signature Capture	11-19
Signature Capture File Format Selector	11-20
Signature Capture Bits Per Pixel	11-21
Signature Capture Width	11-22
Signature Capture Height	11-22
Signature Capture JPEG Quality	11-22
Video View Finder	11-23
Video View Finder Image Size	11-23

Chapter 12: Symbolologies

Introduction	12-1
Setting Parameters	12-1
Scanning Sequence Examples	12-2
Errors While Scanning	12-2
Symbology Parameter Defaults	12-2
Enable/Disable All Code Types	12-9
UPC/EAN/JAN	12-10
UPC-A	12-10
UPC-E	12-10
UPC-E1	12-11
EAN-8/JAN-8	12-11
EAN-13/JAN-13	12-12
Bookland EAN	12-12
Bookland ISBN Format	12-13
ISSN EAN	12-14
Decode UPC/EAN/JAN Supplementals	12-15
User-Programmable Supplementals	12-18
UPC/EAN/JAN Supplemental Redundancy	12-18
UPC/EAN/JAN Supplemental AIM ID Format	12-19
Transmit UPC-A Check Digit	12-20
Transmit UPC-E Check Digit	12-20
Transmit UPC-E1 Check Digit	12-21
UPC-A Preamble	12-22
UPC-E Preamble	12-23
UPC-E1 Preamble	12-24
Convert UPC-E to UPC-A	12-25
Convert UPC-E1 to UPC-A	12-25
EAN/JAN Zero Extend	12-26
UCC Coupon Extended Code	12-26
Coupon Report	12-27
UPC Reduced Quiet Zone	12-28
Code 128	12-29
Set Lengths for Code 128	12-29
GS1-128 (formerly UCC/EAN-128)	12-31
ISBT 128	12-31
ISBT Concatenation	12-32
Check ISBT Table	12-33

ISBT Concatenation Redundancy	12-33
Code 128 <FNC4>	12-34
Code 128 Security Level	12-35
Code 128 Reduced Quiet Zone	12-37
Code 39	12-38
Trioptic Code 39	12-38
Convert Code 39 to Code 32	12-39
Code 32 Prefix	12-39
Set Lengths for Code 39	12-40
Code 39 Check Digit Verification	12-41
Transmit Code 39 Check Digit	12-42
Code 39 Full ASCII Conversion	12-42
Code 39 Security Level	12-43
Code 39 Reduced Quiet Zone	12-45
Code 93	12-46
Set Lengths for Code 93	12-46
Code 11	12-48
Set Lengths for Code 11	12-48
Code 11 Check Digit Verification	12-50
Transmit Code 11 Check Digits	12-51
Interleaved 2 of 5 (ITF)	12-52
Set Lengths for Interleaved 2 of 5	12-52
I 2 of 5 Check Digit Verification	12-54
Transmit I 2 of 5 Check Digit	12-55
Convert I 2 of 5 to EAN-13	12-55
I 2 of 5 Security Level	12-56
I 2 of 5 Reduced Quiet Zone	12-57
Discrete 2 of 5 (DTF)	12-58
Set Lengths for Discrete 2 of 5	12-58
Codabar (NW - 7)	12-60
Set Lengths for Codabar	12-60
CLSI Editing	12-62
NOTIS Editing	12-62
Codabar Security Level	12-63
Codabar Upper or Lower Case Start/Stop Characters	12-64
MSI	12-65
Set Lengths for MSI	12-65
MSI Check Digits	12-67
Transmit MSI Check Digit(s)	12-67
MSI Check Digit Algorithm	12-69
MSI Reduced Quiet Zone	12-69
Chinese 2 of 5	12-70
Matrix 2 of 5	12-71
Set Lengths for Matrix 2 of 5	12-71
Matrix 2 of 5 Check Digit	12-73
Transmit Matrix 2 of 5 Check Digit	12-73
Korean 3 of 5	12-74
Inverse 1D	12-75
GS1 DataBar	12-76
GS1 DataBar Omnidirectional (formerly GS1 DataBar-14), GS1 DataBar Truncated, GS1 DataBar	

Stacked, GS1 DataBar Stacked Omnidirectional	12-76
GS1 DataBar Limited	12-77
GS1 DataBar Expanded, GS1 DataBar Expanded Stacked	12-77
Convert GS1 DataBar to UPC/EAN/JAN	12-78
GS1 DataBar Security Level	12-79
GS1 DataBar Limited Margin Check	12-80
Symbology-Specific Security Features	12-81
Redundancy Level	12-81
Security Level	12-83
1D Quiet Zone Level	12-84
Intercharacter Gap Size	12-85
Composite	12-86
Composite CC-C	12-86
Composite CC-A/B	12-86
Composite TLC-39	12-87
Composite Inverse	12-87
UPC Composite Mode	12-88
Composite Beep Mode	12-89
GS1-128 Emulation Mode for UCC/EAN Composite Codes	12-89
2D Symbologies	12-90
PDF417	12-90
MicroPDF417	12-90
Code 128 Emulation	12-91
Data Matrix	12-92
GS1 Data Matrix	12-92
Data Matrix Inverse	12-93
Decode Data Matrix Mirror Images	12-94
Maxicode	12-95
QR Code	12-96
GS1 QR	12-96
MicroQR	12-97
Linked QR Mode	12-98
Aztec	12-99
Aztec Inverse	12-100
Han Xin	12-101
Han Xin Inverse	12-102
Grid Matrix	12-103
Grid Matrix Inverse	12-103
Grid Matrix Mirror	12-104
DotCode	12-105
DotCode Inverse	12-106
DotCode Mirrored	12-107
DotCode Prioritize	12-108
Macro PDF Features	12-109
Flush Macro Buffer	12-109
Abort Macro PDF Entry	12-109
Postal Codes	12-110
US Postnet	12-110
US Planet	12-110
Transmit US Postal Check Digit	12-111

UK Postal	12-111
Transmit UK Postal Check Digit	12-112
Japan Postal	12-112
Australia Post	12-113
Australia Post Format	12-114
Netherlands KIX Code	12-115
USPS 4CB/One Code/Intelligent Mail	12-115
UPU FICS Postal	12-116
Mailmark	12-116

Chapter 13: OCR Programming

Introduction	13-1
Setting Parameters	13-1
Scanning Sequence Examples	13-2
Errors While Scanning	13-2
OCR Parameter Defaults	13-2
OCR Programming Parameters	13-3
OCR-A	13-3
OCR-A Variant	13-4
OCR-B	13-5
OCR-B Variant	13-6
MICR E13B	13-10
US Currency Serial Number	13-11
OCR Orientation	13-11
OCR Lines	13-13
OCR Minimum Characters	13-13
OCR Maximum Characters	13-14
OCR Subset	13-14
OCR Quiet Zone	13-15
OCR Template	13-15
OCR Check Digit Modulus	13-25
OCR Check Digit Multiplier	13-26
OCR Check Digit Validation	13-27
Inverse OCR	13-32
OCR Redundancy	13-33

Chapter 14: Intelligent Document Capture

Introduction	14-1
The IDC Process	14-1
Bar Code Acceptance Test	14-2
Capture Region Determination	14-2
Image Post Processing	14-3
Data Transmission	14-3
PC Application and Programming Support	14-3
Setting Parameters	14-4
Scanning Sequence Examples	14-4
Errors While Scanning	14-4
Image Document Capture Parameter Defaults	14-5

IDC Operating Mode	14-7
IDC Symbology	14-8
IDC X Coordinate	14-9
IDC Y Coordinate	14-9
IDC Width	14-10
IDC Height	14-10
IDC Aspect	14-11
IDC File Format Selector	14-11
IDC Bits Per Pixel	14-12
IDC JPEG Quality	14-12
IDC Find Box Outline	14-13
IDC Minimum Text Length	14-13
IDC Maximum Text Length	14-14
IDC Captured Image Brighten	14-14
IDC Captured Image Sharpen	14-15
IDC Border Type	14-16
IDC Delay Time	14-17
IDC Zoom Limit	14-17
IDC Maximum Rotation	14-18
Quick Start	14-19
Sample IDC Setup	14-19
IDC Demonstrations	14-20
Other Suggestions	14-21
Quick Start Form	14-21
Chapter 15: Digimarc Bar code	
Introduction	15-1
Digimarc Symbology Selection	15-1
Picklist	15-1
Digimarc Digital Watermarks	15-2
Chapter 16: Data Formatting: ADF, MDF, Preferred Symbol, Data Parsing	
Introduction	16-1
Advanced Data Formatting (ADF)	16-1
Multicode Data Formatting (MDF)	16-1
MDF in Hands-Free Mode	16-2
MDF Best Practices	16-3
Preferred Symbol	16-4
Data Parsing (UDI Scan+, Label Parse+ and Blood Bag Parse+)	16-5
Scan a UDI Label using UDI Scan+	16-5
Scan a GS1 Label using Label Parse+	16-5
Scan a Blood Bag Label using Blood Bag Parse+	16-5
Chapter 17: Driver's License Set Up (DS8108-DL)	
Introduction	17-1
Driver's License Parsing	17-2
Parsing Driver's License Data Fields (Embedded Driver's License Parsing)	17-3

Embedded Driver's License Parsing Criteria - Code Type	17-3
Driver's License Parse Field Bar Codes	17-4
AAMVA Parse Field Bar Codes	17-7
Parser Version ID Bar Code	17-17
User Preferences	17-17
Set Default Parameter	17-17
Output Gender as M or F	17-17
Date Format	17-18
Send Keystroke (Control Characters and Keyboard Characters)	17-20
Parsing Rule Example	17-39
Embedded Driver's License Parsing ADF Example	17-43

Appendix A: Standard Parameter Defaults

Appendix B: Numeric Bar Codes

Numeric Bar Codes	B-1
Cancel	B-3

Appendix C: Alphanumeric Bar Codes

Cancel	C-1
Alphanumeric Bar Codes	C-2

Appendix D: ASCII Character Sets

Appendix E: Programming Reference

Symbol Code Identifiers	E-1
AIM Code Identifiers	E-3

Appendix F: Communication Protocol Functionality

Functionality Supported via Communication (Cable) Interface	F-1
---	-----

Appendix G: Country Codes

Introduction	G-1
USB and Keyboard Wedge Country Keyboard Types (Country Codes)	G-2

Appendix H: Country Code Pages

Introduction	H-1
Country Code Page Defaults	H-1
Country Code Page Bar Codes	H-5

Appendix I: CJK Decode Control

Introduction	I-1
--------------------	-----

CJK Control Parameters	I-2
Unicode Output Control	I-2
CJK Output Method to Windows Host	I-3
Non-CJK UTF Bar Code Output	I-5
Unicode/CJK Decode Setup with Windows Host	I-7
Setting Up the Windows Registry Table for Unicode Universal Output	I-7
Adding CJK IME on Windows	I-7
Selecting the Simplified Chinese Input Method on the Host	I-8
Selecting the Traditional Chinese Input Method on the Host	I-9

Appendix J: Signature Capture Code

Introduction	J-1
Code Structure	J-1
Signature Capture Area	J-1
CapCode Pattern Structure	J-2
Start / Stop Patterns	J-2
Dimensions	J-3
Data Format	J-3
Additional Capabilities	J-4
Signature Boxes	J-4

Appendix K: Non-Parameter Attributes (Attribute Data Dictionary)

Introduction	K-1
Attributes	K-1
Model Number	K-1
Serial Number	K-1
Date of Manufacture	K-2
Date of First Programming	K-2
Configuration Filename	K-2
Beeper/LED	K-3
Parameter Defaults	K-4
Beep on Next Bootup	K-4
Reboot	K-4
Host Trigger Session	K-4
Firmware Version	K-5
Scankit Version	K-5
ScanSpeed Analytics	K-5

Appendix L: Sample Bar Codes

UPC/EAN	L-1
UPC-A, 100%	L-1
UPC-A with 2-digit Add-on	L-1
UPC-A with 5-digit Add-on	L-2
UPC-E	L-2
UPC-E with 2-digit Add-on	L-2
UPC-E with 5-digit Add-on	L-3
EAN-8	L-3

EAN-13, 100%	L-3
EAN-13 with 2-digit Add-on	L-4
EAN-13 with 5-digit Add-on	L-4
Code 128	L-4
GS1-128	L-5
Code 39	L-5
Code 93	L-5
Code 11 with 2 Check Digits	L-6
Interleaved 2 of 5	L-6
MSI with 2 Check Digits	L-6
Chinese 2 of 5	L-7
Matrix 2 of 5	L-7
Korean 3 of 5	L-7
GS1 DataBar	L-8
GS1 DataBar Omnidirectional (formerly GS1 DataBar-14)	L-8
GS1 DataBar Truncated	L-8
GS1 DataBar Stacked	L-8
GS1 DataBar Stacked Omnidirectional	L-9
GS1 DataBar Limited	L-9
GS1 DataBar Expanded	L-9
GS1 DataBar Expanded Stacked	L-10
2D Symbolologies	L-10
PDF417	L-10
Data Matrix	L-11
GS1 Data Matrix	L-11
Maxicode	L-11
QR Code	L-12
GS1 QR	L-12
MicroQR	L-12
Aztec	L-13
Han Xin	L-13
Grid Matrix	L-13
Postal Codes	L-14
US Postnet	L-14
UK Postal	L-14
Japan Postal	L-14
Australian Post	L-15
OCR	L-15
OCR-A	L-15
OCR-B	L-15
MICR E13B	L-16
US Currency	L-16

Appendix M: Scan Speed Analytics

Introduction	M-1
Histogram Decode Information	M-1
Image of Slowest Decoded Bar Code	M-5

Index

ABOUT THIS GUIDE

Introduction

The *DS8108 Digital Scanner Product Reference Guide* provides general instructions for setting up, operating, maintaining, and troubleshooting the DS8108 digital scanner.

Configurations

This guide includes the DS8108 series digital scanner configurations listed below.

Model Configuration	Description
DS8108-HC4000BVZWW	DS8108: Area Imager, Healthcare, Healthcare White, Pager
DS8108-SR00007ZZWW	DS8108: Area Imager, Standard Range, Twilight Black
DS8108-SR00006ZZWW	DS8108: Area Imager, Standard Range, Nova White
DS8108-DL00007ZZWW	DS8108: Area Imager, Standard Range, DL Parsing, Twilight Black
DS8108-DL00006ZZWW	DS8108: Area Imager, Standard Range, DL Parsing, Nova White
DS8108-SR00007ZCWW	DS8108: Area Imager, Standard Range, Checkpoint EAS, Twilight Black
DS8108-SR00007ZZK	DS8108: Area Imager, Standard Range, Korea and India only, Twilight Black
DS8108-TT00007ZZJP	DS8108: Area Imager, Standard Range with Toshiba Tec, Corded, Twilight Black - Japan only

Related Product Line Configurations/Accessories

The product configurations related to the DS8108 digital scanner are as follows.

- ✓ **NOTES** Check Solution Builder for additional information regarding all available accessories, and the latest available configurations.

Product ID	Description
Stands	
20-71043-04R	Gooseneck Intellistand; Black
20-71043-0BR	Gooseneck Intellistand; Healthcare White
21-71043-0BR	Cup; Healthcare White
21-71043-04R	Cup; Black
22-71043-0BR	Gooseneck Intellistand, Weighted; Healthcare White
STND-GS00UNC-04	Universal Gooseneck Intellistand; Black
STND-DC1081C-04	Document Capture Stand; Black
20-67176-01R	Desktop Holder
11-66553-06R	Wall Mount Holder

Cables

The full list of supported cables can be found at:

https://partnerportal.zebra.com/PartnerPortal/product_services/downloads_z/barcode_scanners/Universal-Cable-Guide-Bar-Code-Scanners.xlsx.

Chapter Descriptions

Topics covered in this guide are as follows:

- [Chapter 1, Getting Started](#) provides a product overview, unpacking instructions, and cable connection information.
- [Chapter 2, 123Scan and Software Tools](#) describes the Zebra software tools available for customizing scanner operation.
- [Chapter 3, Data Capture](#) provides beeper and LED definitions, scanning instructions and tips, and decode ranges.
- [Chapter 4, Maintenance, Troubleshooting, & Technical Specifications](#) provides suggested scanner maintenance, troubleshooting, technical specifications, and signal descriptions (pinouts).
- [Chapter 5, USB Interface](#) describes how to set up the scanner with a USB host.
- [Chapter 6, SSI Interface](#) describes the system requirements of the Simple Serial Interface (SSI), which provides a communications link between Zebra decoders and a serial host.
- [Chapter 7, RS-232 Interface](#) describes how to set up the scanner with an RS-232 host.
- [Chapter 8, IBM 468X / 469X Interface](#) describes how to set up the scanner with an IBM 468X/469X host.

- [Chapter 9, Keyboard Wedge Interface](#) describes how to set up a keyboard wedge interface with the scanner.
- [Chapter 10, User Preferences & Miscellaneous Options](#) describes each user preference feature and provides programming bar codes for selecting these features.
- [Chapter 11, Image Capture Preferences](#) describes imaging preference features and provides programming bar codes for selecting these features.
- [Chapter 12, Symbologies](#) describes all symbology features and provides programming bar codes for selecting these features.
- [Chapter 13, OCR Programming](#) describes how to set up the scanner for OCR programming.
- [Chapter 14, Intelligent Document Capture](#) describes IDC, an advanced image processing firmware, including IDC functionality, parameter bar codes to control its features, and a quick start procedure.
- [Chapter 15, Digimarc Bar code](#) provides bar codes to either enable or disable Digimarc Barcode, a machine-readable code that is invisible to people.
- [Chapter 16, Data Formatting: ADF, MDF, Preferred Symbol, Data Parsing](#) briefly describes the Zebra features available for customizing scanner operation.
- [Chapter 17, Driver's License Set Up \(DS8108-DL\)](#) describes how to program the DS8108-DL scanner to read and use the data contained in the 2D bar codes on US driver's licenses and AAMVA compliant ID cards.
- [Appendix A, Standard Parameter Defaults](#) provides a table of all host and miscellaneous scanner defaults.
- [Appendix B, Numeric Bar Codes](#) includes the numeric bar codes to scan for parameters requiring specific numeric values.
- [Appendix C, Alphanumeric Bar Codes](#) includes the alphanumeric bar codes to scan for parameters requiring specific alphanumeric values.
- [Appendix D, ASCII Character Sets](#) provides tables for ASCII character values and other character sets.
- [Appendix E, Programming Reference](#) provides tables for Symbol code identifiers, AIM code identifiers, and modifier characters.
- [Appendix F, Communication Protocol Functionality](#) lists supported scanner functionality by communication protocol.
- [Appendix G, Country Codes](#) provides bar codes for programming the country keyboard type for the USB keyboard (HID) device and the keyboard wedge host.
- [Appendix H, Country Code Pages](#) provides bar codes for selecting code pages for the country keyboard type.
- [Appendix I, CJK Decode Control](#) describes control parameters for Unicode/CJK (Chinese, Japanese, Korean) bar code decode through USB HID Keyboard Emulation mode.
- [Appendix J, Signature Capture Code](#) describes CapCode, a special pattern that encloses a signature area on a document and allows the scanner to capture a signature.
- [Appendix K, Non-Parameter Attributes \(Attribute Data Dictionary\)](#) defines non-parameter attributes.
- [Appendix L, Sample Bar Codes](#) includes sample bar codes of various code types.
- [Appendix M, Scan Speed Analytics](#) describes the Zebra ScanSpeed Analytics software that allows the identification of bar codes that slow down processes.

Notational Conventions

The following conventions are used in this document:

- *Italics* are used to highlight the following:
 - Chapters and sections in this guide
 - Related documents
- **Bold** text is used to highlight the following:
 - Parameter names and options
 - Parameter bar code captions
 - Dialog box, window, and screen names
 - Drop-down list and list box names
 - Check box and radio button names
 - Icons on a screen
 - Key names on a keypad
 - Button names on a screen.
- Bullets (•) indicate:
 - Action items
 - Lists of alternatives
 - Lists of required steps that are not necessarily sequential.
- Sequential lists (e.g., those that describe step-by-step procedures) appear as numbered lists.

Related Documents and Software

The following documents provide more information about the DS8108 scanner and other reference information.

- *DS8108 Quick Start Guide*, p/n MN-002927-xx, provides general information for getting started with the DS8108 scanner, and includes basic set up and operation instructions.
- *Advanced Data Formatting Programmer Guide*, p/n 72E-69680-xx, provides information on ADF, a means of customizing data before transmission to a host.
- *Multicode Data Formatting and Preferred Symbol*, p/n MN-002895-xx, provides information on Multicode Data Formatting (MDF), which enables a 2D imaging scanner to scan all bar codes on a label, and then modify and transmit the data to meet host application requirements.
- *Toshiba TEC Programmer's Guide*, p/n MN-002707-xx, provides information on programming the Toshiba TEC USB device type.

For the latest version of this guide and all guides, go to: zebra.com/support.

Service Information

If you have a problem with your equipment, contact Zebra Global Customer Support for your region. Contact information is available at: zebra.com/support.

When contacting support, please have the following information available:

- Serial number of the unit
- Model number or product name
- Software type and version number.

Zebra responds to calls by email, telephone or fax within the time limits set forth in support agreements.

If your problem cannot be solved by Zebra Customer Support, you may need to return your equipment for servicing and will be given specific directions. Zebra is not responsible for any damages incurred during shipment if the approved shipping container is not used. Shipping the units improperly can possibly void the warranty.

If you purchased your Zebra business product from a Zebra business partner, contact that business partner for support.

CHAPTER 1 GETTING STARTED

Introduction

The DS8108 combines superior 1D and 2D omnidirectional bar code scanning and transfer with a light-weight, Hands-free/Hand-held design. The digital scanner's Intellistand seamlessly accommodates both counter top and Hand-held use. Whether in Presentation (Hands-free) or Hand-held mode, the digital scanner ensures comfort and ease of use for extended periods of time.

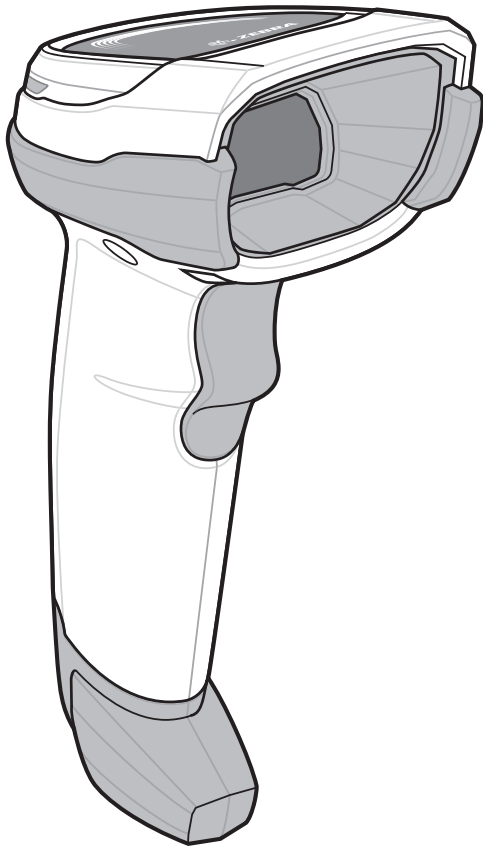

Figure 1-1 *DS8108 Digital Scanner*

Interfaces

The DS8108 digital scanner supports:

- USB connection to a host. The digital scanner automatically detects the USB host interface type and uses the default setting (**USB Keyboard HID**). If the default (*) does not meet your requirements, select another USB interface type by scanning programming bar code menus. See [Appendix G, Country Codes](#) for the interface supported international keyboards (for Windows® environment).
- Standard RS-232 connection to a host. The digital scanner automatically detects the RS-232 host interface type and uses the default setting (**Standard RS-232**). If the default (*) does not meet your requirements, select another RS-232 interface type by scanning programming bar code menus.
- Connection to IBM 468X/469X hosts. The digital scanner automatically detects the IBM host interface type but does not select a default setting. Scan bar code menus to set up communication of the digital scanner with the IBM terminal.
- Keyboard Wedge connection to a host. The host interprets scanned data as keystrokes. The digital scanner automatically detects the Keyboard Wedge host interface type and uses the default setting (**IBM AT Notebook**). If the default (*) does not meet your requirements, scan *IBM PC/AT & IBM PC Compatibles* on page 9-4. See [Appendix G, Country Codes](#) for the interface supported international keyboards (for Windows® environment).
- Configuration via 123Scan.

✓ **NOTE** For a list of supported scanner functionality by communication protocol, see [Appendix F, Communication Protocol Functionality](#).

Unpacking

Remove the digital scanner from its packing and inspect it for damage. If the scanner was damaged in transit, contact support. See *page xxv* for information. **KEEP THE PACKING**. It is the approved shipping container; use this to return the equipment for servicing.

The digital scanner ships with the *DS8108 Quick Start Guide*. The following required accessories must be ordered:

- Interface cable for the appropriate interface.
- Universal power supply, if the interface requires this.
- Intellistand for Hands-free operation of the DS8108.
- Document Capture Stand for capturing images on documents.

See *Related Product Line Configurations/Accessories* on *page xxii*. For additional items, contact a local Zebra representative or business partner.

Setting Up the Digital Scanner

Installing the Interface Cable

1. Insert the interface cable modular connector into the interface cable port on the rear of the digital scanner until you hear a click.

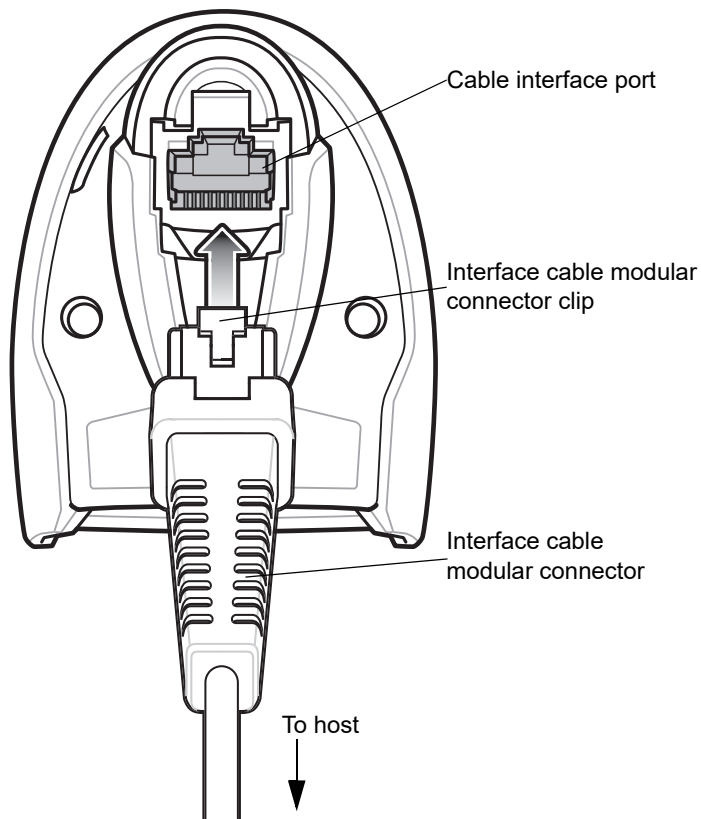

Figure 1-2 *Installing the Cable - DS8108*



IMPORTANT Insert the cable into the cable interface port until a click sounds.

If you already have existing non shielded cables from legacy products (such as the LS2208) they can be reused. However, be aware that the shielded cables provide improved ESD performance. For regional information about cables and cable compatibility, go to the Zebra Partner Portal at: https://partnerportal.zebra.com/PartnerPortal/product_services/downloads_z/barcode_scanners/Universal-Cable-Guide-Bar-Code-Scanners.xlsx.

2. Gently tug the cable to ensure the connector is secure.
3. Connect the other end of the interface cable to the host (see the specific host chapter for information on host connections).

Removing the Interface Cable

1. Press the cable's modular connector clip through the access slot in the digital scanner's base.

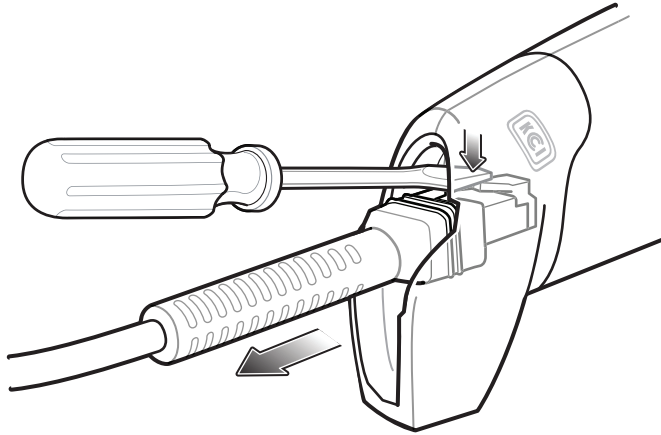

Figure 1-3 Removing the Cable

2. Carefully slide out the cable.
3. Follow the steps for [Installing the Interface Cable](#) to connect a new cable.

Connecting Power (if required)

If the host does not provide power to the digital scanner, connect an external power supply.

1. Plug the power supply into the power jack on the interface cable.
2. Plug the other end of the power supply into an AC outlet.

Configuring the Digital Scanner

To configure the digital scanner use the bar codes included in this manual, or use the 123Scan configuration program. See [Chapter 10, User Preferences & Miscellaneous Options](#), and [Chapter 12, Symbologies](#) for information about programming the digital scanner using bar code menus. See [Chapter 2, 123Scan and Software Tools](#) for information on using this configuration program. Also see each host-specific chapter to set up connection to a specific host type.

CHAPTER 2 123SCAN AND SOFTWARE TOOLS

Introduction

This chapter briefly describes the Zebra software tools available for customizing scanner operation.

123Scan

123Scan is a software tool that simplifies scanner setup and more.

Intuitive enough for first time users, the 123Scan wizard guides users through a streamlined setup process. Settings are saved in a configuration file that can be printed as a single programming bar code for scanning, emailed to a smart phone for scanning from its screen, or downloaded to the scanner using a USB cable.

Through 123Scan a user can:

- Configure a scanner using a wizard.
 - Program the following scanner settings:
 - Beeper tone / volume settings.
 - Enable / disable symbologies.
 - Communication settings.
 - Modify data before transmission to a host using:
 - Advanced Data Formatting (ADF) - Scan one bar code per trigger pull.
 - Multicode Data Formatting (MDF) - Scan many bar codes in one trigger pull (select scanners).
 - Preferred Symbol - Single out one barcode on label of many (select scanners).
- Load parameter settings to a scanner via the following.
 - Bar code scanning:
 - Scan a paper bar code.
 - Scan a bar code from a PC screen.
 - Scan a bar code from a smart phone screen.
 - Download over a USB cable.
 - Load settings to one scanner.

- Stage up to 10 scanners simultaneously (Powered USB Hub recommended with 0.5 amp / port).
- Validate scanner setup.
 - View scanned data within the utility's **Data** view screen.
 - Capture an image and save to a PC within the utility's **Data** view screen.
 - Review settings using the Parameter Report.
 - Clone settings from an already deployed scanner from the **Start** screen.
- Upgrade scanner firmware.
 - Load settings to one scanner.
 - Stage up to 10 scanners simultaneously (Powered USB Hub recommended with 0.5 amp / port).
- View statistics such as:
 - Asset tracking information
 - Time and usage information
 - Bar codes scanned by symbology
 - Battery diagnostics (select scanners).
- Generate the following reports.
 - Bar Code Report - Programming bar code, included parameter settings, and supported scanner models.
 - Parameter Report - Lists parameters programmed within a configuration file.
 - Inventory Report - Lists scanner asset tracking information.
 - Validation Report - Printout of scanned data from the **Data** view.
 - Statistics Report - Lists all statistics retrieved from the scanner.

For more information go to: zebra.com/123Scan.

Communication with 123Scan

Use a USB cable to connect the scanner to a Windows host computer running 123Scan.

123Scan Requirements

- Host computer running Windows 7, 8, and 10
- Scanner
- USB cable.

123Scan Information

For more information on 123Scan, go to: zebra.com/123Scan.

For a 1 minute tour of 123Scan, go to: zebra.com/ScannerHowToVideos.

To see a list of all of our software tools, go to: zebra.com/scannersoftware.

Scanner SDK, Other Software Tools, and Videos

Tackle all your scanner programming needs with our diversified set of software tools. Whether you need to simply stage a device, or develop a fully featured application with image and data capture as well as asset management, these tools help you every step of the way.

To download any of the following free tools, go to: zebra.com/scannersoftware.

- 123Scan configuration utility
- SDKs
 - Scanner SDK for Windows
 - Scanner SDK for Linux
 - Scanner SDK for Android
 - Scanner SDK for iOS
- Drivers
 - OPOS driver
 - JPOS driver
 - USB CDC driver
 - TWAIN driver
- Scanner Management Service (SMS) for Remote Management
 - Windows
 - Linux
- Mobile Apps
 - Scanner Control App
 - Android
 - iOS
 - Scan-To-Connect Utility
 - Android
 - Windows
- How-To-Videos



NOTE: For a list of SDK supported scanner functionality by communication protocol, see [Appendix F, Communication Protocol Functionality](#).

Scanner Control App

The Scanner Control App (SCA) allows you to control a Bluetooth scanner from a phone or tablet without a cradle. Use this app to showcase a Zebra Bluetooth scanner's capabilities and ease of control right from your phone.

The Scanner Control App supports Scan-To-Connect technology for one-step Bluetooth pairing, and allows you to control the following scanner functions:

- Program the beeper and LEDs.
- Enable and disable symbologies.
- Remotely trigger a scan.

The app displays scanned bar code data, and can query scanner asset information and battery health statistics.

The Scanner Control App also works with USB connected scanners like the MP7000, assuming your Android tablet has a powered USB Host port.

The Scanner Control app is available on the Android Play, iOS App, and Zebra AppGallery stores. Source code is available within the Zebra Scanner SDK for Android and iOS.

To watch a 1 minute tour of the Scanner Control App, go to: zebra.com/scannercontrolapp.

CHAPTER 3 DATA CAPTURE

Introduction

This chapter provides beeper and LED definitions, techniques involved in scanning bar codes, general instructions and tips about scanning, and decode ranges.

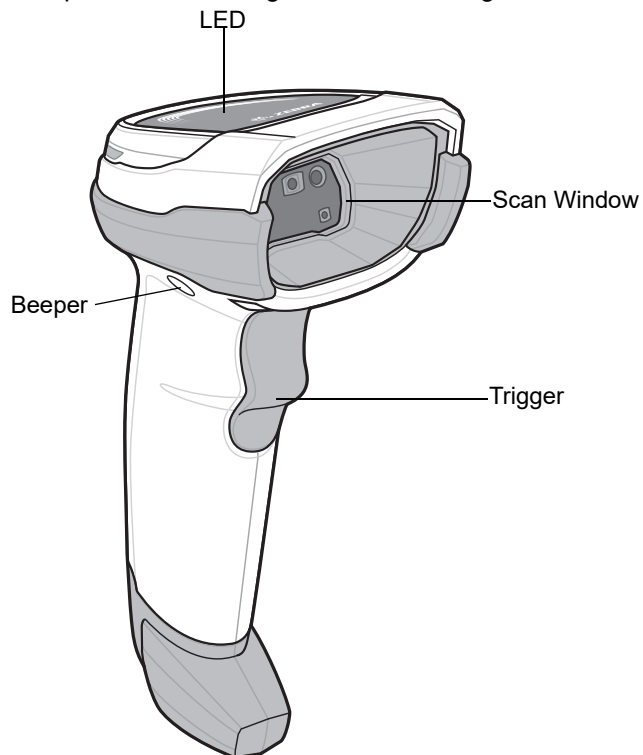

Figure 3-1 *Parts of the DS8108*

Beeper and LED Indicators

In addition to beep sequences, the digital scanner uses a two-color LED to indicate status.

[Table 3-1](#) defines beep sequences that occur during both normal scanning and while programming the digital scanner; LED colors that display during scanning.

Table 3-1 *Digital Scanner Beeper and LED Indications*

Beeper Sequence	LED	Indication
Standard Use		
Low/medium/high beeps	Green	Power up.
Scanning		
Medium beep (or as configured)	Green flash	A bar code was successfully decoded. (See <i>User Preferences Parameter Defaults on page 10-2</i> for programming beeper sounds.)
None	Green solid	Presentation (Hands-free) Mode on.
None	No LED; green LED is turned off	Presentation (Hands-free) Mode off.
Low/low/low/extra low beeps	Red	Parity error.
Four long low beeps	Red	A transmission error occurred. The data is ignored. This occurs if a unit is not properly configured. Check option setting.
Five long low beeps	Red	Conversion or format error.
None	Red (fast blink)) on trigger pull	Scanner is disabled by a host command to the scanner.
Parameter Programming		
Long low/long high beeps	Red	Input error; incorrect bar code or Cancel scanned, wrong entry, incorrect bar code programming sequence; remain in program mode.
High/low beeps	Green	Number expected. Enter value using numeric bar codes.
High/low/high/low beeps	Green	Successful program exit with change in the parameter setting.
ADF Programming		
Low/high/low beeps	None	ADF transmit error.
High/low beeps	Green	Number expected. Enter another digit. Add leading zeros to the front if necessary.

Table 3-1 Digital Scanner Beeper and LED Indications (Continued)

Beeper Sequence	LED	Indication
Low/low beeps	Green	Alphanumeric expected. Enter another alphanumeric character or scan the End of Message bar code.
High/high beeps	Green blinking	ADF criteria or action is expected. Enter another criteria or action or scan the Save Rule bar code.
High/low/low beeps	Green	All criteria or actions cleared for current rule, continue entering rule.
High/low/high/low beeps	Green (turns off blinking)	Rule saved. Rule entry mode exited.
Long low/long high beeps	Red	Rule error. Entry error, wrong bar code scanned, or criteria/action list is too long for a rule. Re-enter criteria or action.
Low beep	Green	Deleted last saved rule. The current rule is left intact.
Low/high/high beeps	Green	All rules deleted.
Long low/long high/long low/long high beeps	Red	Out of rule memory. Erase some existing rules, then try to save rule again.
Long low/long high/long low beeps	Green (turns off blinking)	Cancel rule entry. Rule entry mode exited because of an error or the user asked to exit rule entry.
Host Specific		
USB only		
Four high beeps	None	Digital scanner has not completed initialization. Wait several seconds and scan again.
RS-232 only		
High/high/high/low beeps	Red	RS-232 receive error.
High beep	None	A <BEL> character is received when Beep on <BEL> is enabled (Point-to-Point mode only).

Scanning

The DS8108 digital scanner is in Hands-free (presentation) mode when it is placed in the Intellistand. In this mode, the digital scanner operates in continuous (constant-on) mode, where it automatically decodes a bar code presented in its field of view.

When the digital scanner is not used for a user-definable period of time, it enters a low power mode in which the LEDs are turned off or illumination blinks at a low duty cycle until the digital scanner detects an image change (e.g. motion).

Scanning in Presentation (Hands-free) Mode

The optional stand adds greater flexibility to DS8108 scanning operation. When the scanner is seated in the scanner cup, the scanner's built-in sensor places the scanner in Hands-free (presentation) mode. When the scanner is removed from the stand, it automatically switches to its programmed hand-held triggered mode.

Assembling the Stand

To assemble the stand:

1. Unscrew the wing nut from the bottom of the one piece scanner "cup."

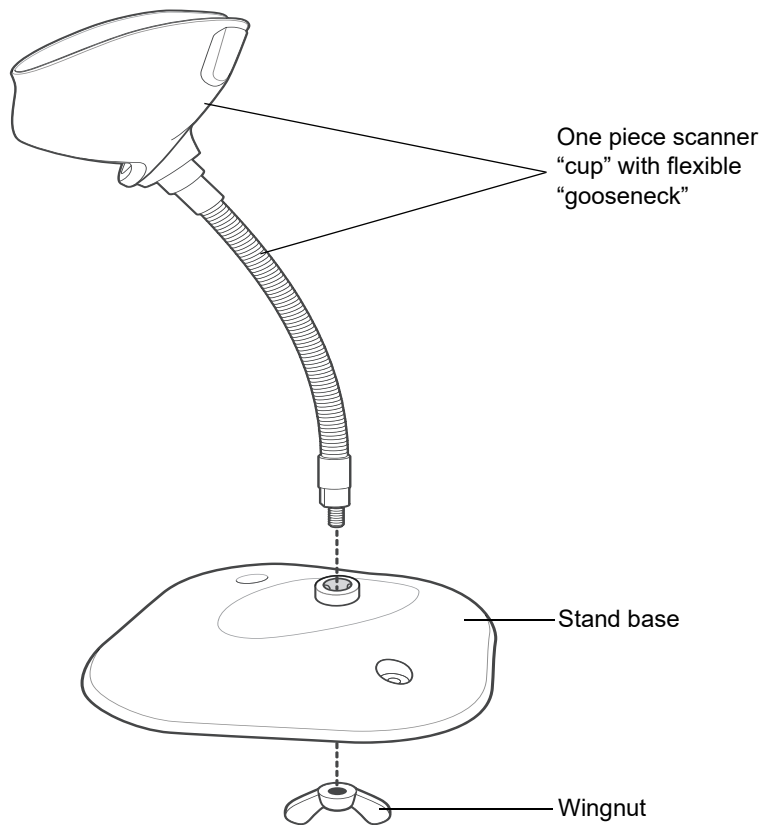

Figure 3-2 *Assembling the Stand*

2. Fit the bottom of the gooseneck piece into the opening on the top of the stand base.
3. Tighten the wing nut underneath the base to secure the cup and neck piece to the base.
4. Bend the neck to the desired position for scanning.

Mounting the Stand (optional)

You can attach the base of the scanner's stand to a flat surface using two screws or double-sided tape (not provided).

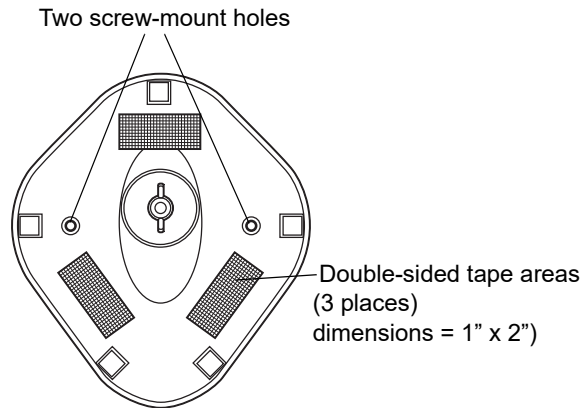

Figure 3-3 *Mounting the Stand*

Screw Mount

1. Position the assembled base on a flat surface.
2. Screw one #10 wood screw into each screw-mount hole until the base of the stand is secure (see [Figure 3-3](#)).

Tape Mount

1. Peel the paper liner off one side of each piece of tape and place the sticky surface over each of the three rectangular tape holders.
2. Peel the paper liner off the exposed sides of each piece of tape and press the stand on a flat surface until it is secure (see [Figure 3-3](#)).

Scanning with the Stand

When the digital scanner is placed in the gooseneck Intellistand it operates in continuous (constant-on) mode, where it automatically decodes a bar code presented in its field of view.

To operate the scanner in the stand:

1. Ensure the scanner is properly connected to the host (see the appropriate host chapter for information on host connections).
2. Insert the scanner in the gooseneck Intellistand by placing the front of the scanner into the stand cup.

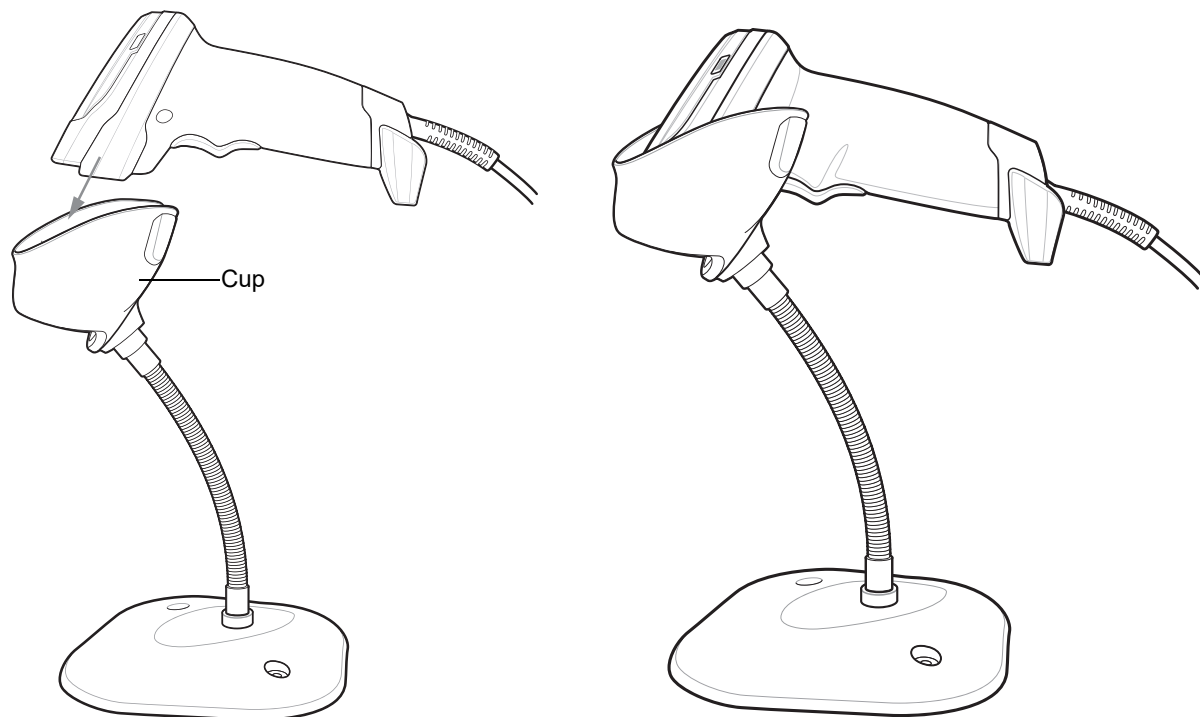

Figure 3-4 *Inserting the Scanner in the Gooseneck Intellistand*

3. Adjust the scan angle by bending the stand's flexible gooseneck body.
4. Present the bar code. Upon successful decode, the scanner beeps and the LED momentarily shuts off. For more information about beeper and LED definitions, see [Table 3-1](#).

Scanning in Hand-held Mode

Aim the digital scanner at a bar code and pull the trigger to decode.

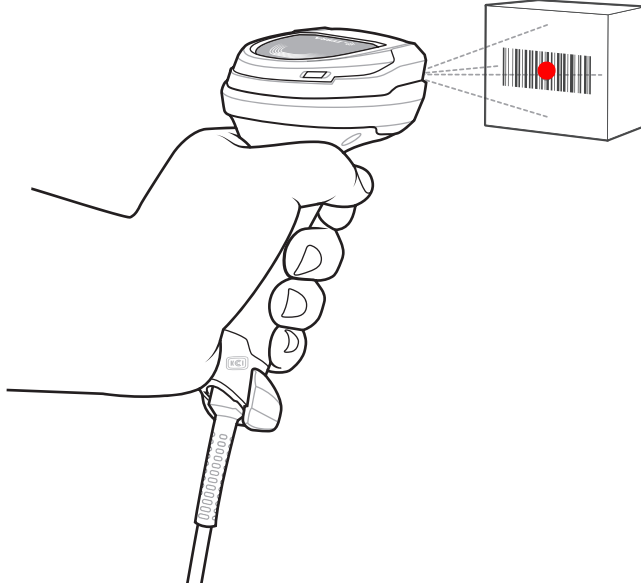

Figure 3-5 Scanning DS8108 -SR in Hand-held Mode

Aiming

When scanning, the digital scanner projects a red LED dot which allows positioning the bar code within its field of view. See *Decode Ranges* on page 3-9 for the proper distance to achieve between the digital scanner and a bar code.

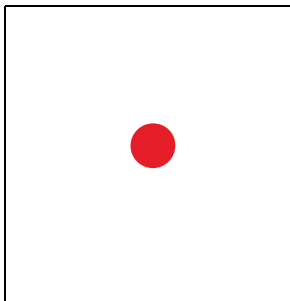

Figure 3-6 Aiming Dot

To scan a bar code, center the symbol and ensure the entire symbol is within the rectangular area formed by the illumination LEDs.

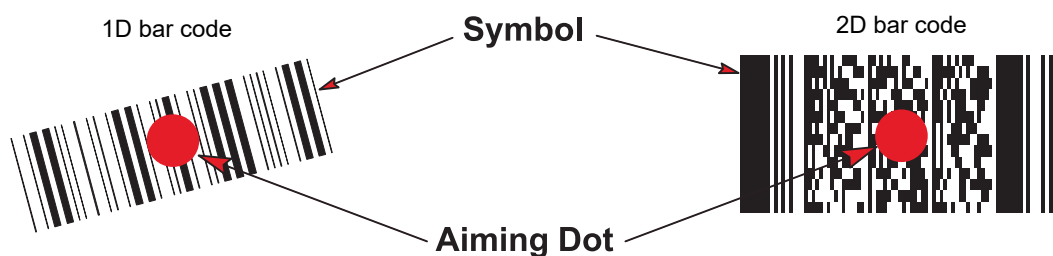

Figure 3-7 Scanning Orientation with Aiming Dot

The digital scanner can also read a bar code presented within the aiming dot not centered. The top examples in [Figure 3-8](#) show acceptable aiming options, while the bottom examples can not be decoded.

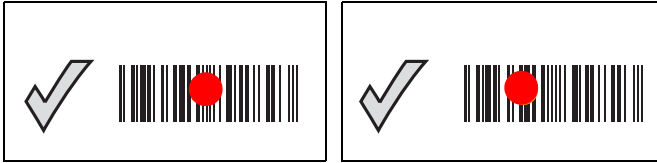

Figure 3-8 *Acceptable Aiming*

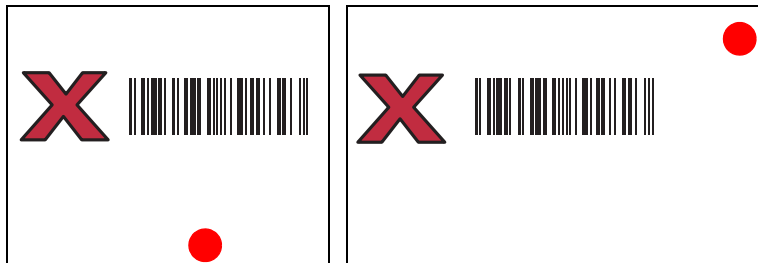

Figure 3-9 *Incorrect Aiming*

The aiming dot is smaller when the digital scanner is closer to the symbol and larger when it is farther from the symbol. Scan symbols with smaller bars or elements (mil size) closer to the digital scanner, and those with larger bars or elements (mil size) farther from the digital scanner.

The digital scanner beeps to indicate that it successfully decoded the bar code. For more information on beeper and LED definitions, see [Table 3-1](#).

Decode Ranges

DS8108-SR/DL Configurations

Table 3-2 DS8108 -SR/DL Decode Ranges

Bar Code Type	Symbol Density	DS8108 -SR/DL Typical Working Ranges		
		Range	In	Cm
Code 39	3 mil	Near	2.2	5.5
		Far	5.0	12.8
	20 mil	Near	0.0	0.0
		Far	36.8	93.6
Code 128	3 mil	Near	2.6	6.5
		Far	4.5	11.4
	5 mil	Near	1.6	4.0
		Far	8.4	21.4
	15 mil	Near	0.0	0.0
		Far	27.1	68.8
100% UPC	13 mil	Near	0.0	0.0
		Far	24.0	61.0
PDF417	5 mil	Near	2.3	5.9
		Far	6.4	16.3
	6.67 mil	Near	1.8	4.5
		Far	8.5	21.7
Data Matrix	7.5 mil	Near	2.1	5.3
		Far	6.9	17.4
	10 mil	Near	1.1	2.8
		Far	9.9	25.2
QR Code	10 mil	Near	1.0	2.4
		Far	8.6	21.7
	20 mil	Near	0.1	0.3
		Far	17.6	44.6

DS8108-HC Configurations

Table 3-3 DS8108 -HC Decode Ranges

Bar Code Type	Symbol Density	DS8108 -HC Typical Working Ranges		
		Range	In	Cm
Code 39	3 mil	Near	1.4	3.4
		Far	5.1	13.1
	20 mil	Near	0.0	0.0
		Far	22.4	56.8
Code 128	3 mil	Near	1.8	4.5
		Far	4.1	10.4
	5 mil	Nears	1.2	3.1
		Far	8.1	20.5
	15 mil	Near	1.0	2.5
		Far	16.9	42.8
100% UPC	13 mil	Near	0.0	0.0
		Far	15.9	40.5
PDF417	5 mil	Near	1.5	3.8
		Far	6.1	15.5
	6.67 mil	Near	1.1	2.8
		Far	8.1	20.7
Data Matrix	5.0 mil	Near	1.9	4.8
		Far	4.5	11.4
	7.5 mil	Near	1.3	3.3
		Far	6.7	17.1
	10 mil	Near	0.6	1.6
		Far	8.5	21.6
QR Code	10 mil	Near	0.6	1.5
		Far	7.7	19.5
	20 mil	Near	0.0	0.0
		Far	12.5	31.6

Assembling the Document Capture Stand

The DS8108 Document Capture Stand provides hands-free digital imaging operation. The stand components ([Figure 3-10](#)) ship as a kit (p/n KT8108-DC-STND) which includes the Document Capture Base and the Cup and Neck in Stand Base.

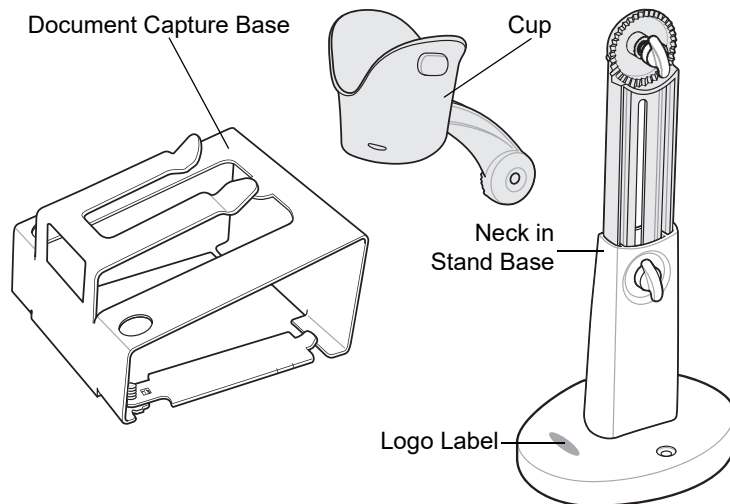

Figure 3-10 Document Capture Stand Components

The stand can be used with the digital scanner to capture images on paper sizes up to A4 and letter (8½ in x 11 in).

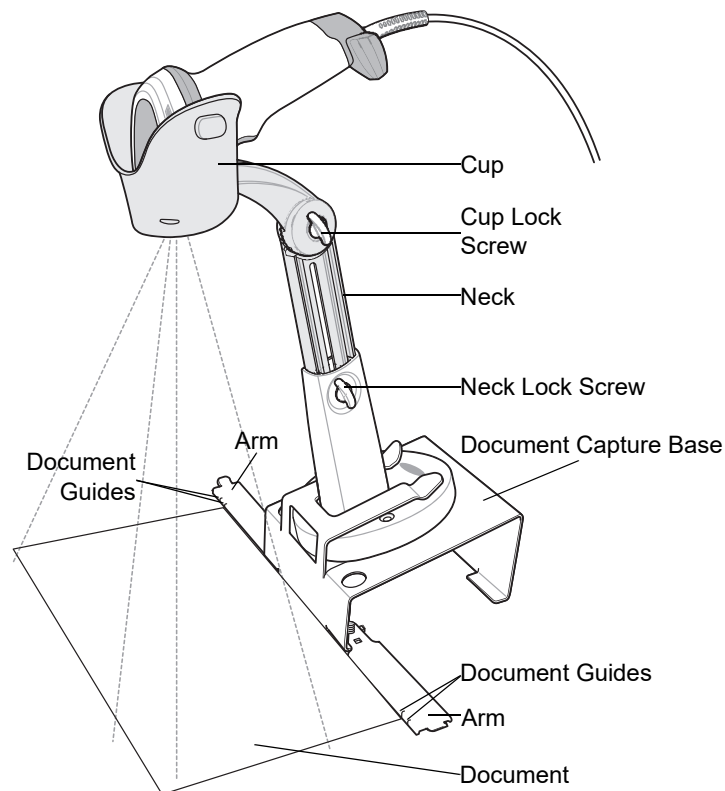

Figure 3-11 Document Capture Stand Features

Assembly

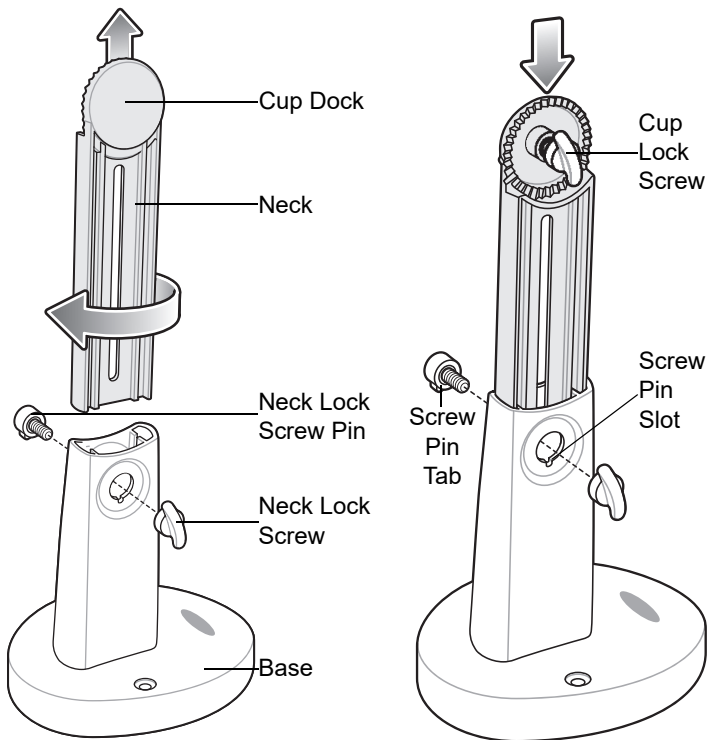

Figure 3-12 *Assembling the Stand*

1. Turn the neck lock screw counterclockwise and remove the neck lock screw and neck lock screw pin.
2. Lift the neck out of the base and turn it 180 degrees so that the cup lock screw faces front (as shown).
3. Insert the neck into the base to the highest allowable height for the maximum field of view. The neck can be lowered as needed to decrease the field of view and increase resolution for smaller sized documents.
4. Replace the neck lock screw pin and neck lock screw. Ensure the screw pin tab fits into the screw pin slot.
5. Turn the neck lock screw clockwise until tight.
6. Remove the cup lock screw from the cup dock, if applicable.
7. Attach the cup to the cup dock, interlocking the grooves.

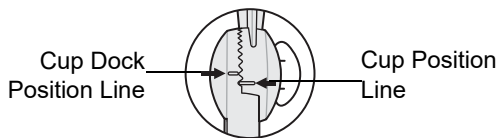

Figure 3-13 *Cup Docking Interlock*



IMPORTANT

For proper document capture, the position lines on the cup and the cup dock should appear as shown in the diagram above. The position line on the cup dock should be one groove above the position line on the cup.

8. Replace the cup lock screw and turn clockwise until tight.
9. Slide the assembled stand into the document capture base.

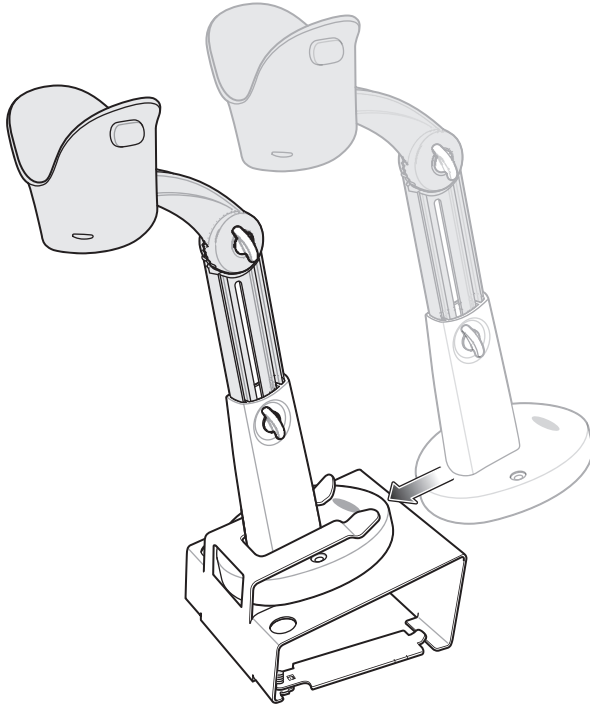

Figure 3-14 *Sliding Document Capture Stand Into Base*

10. Slide out the Document Capture Base arms.

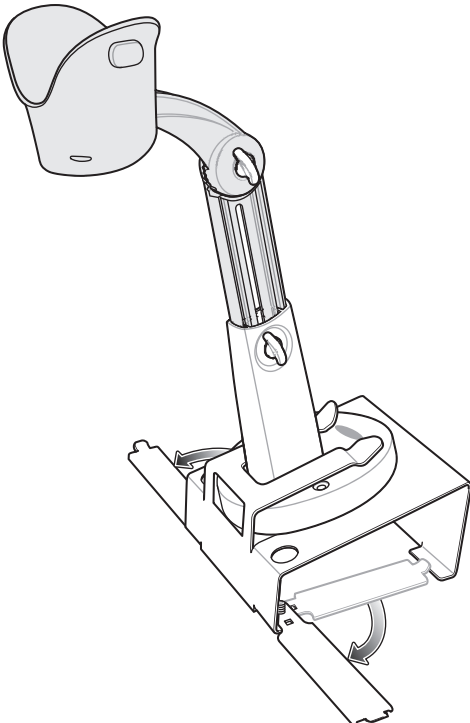

Figure 3-15 *Positioning the Document Capture Stand Arms*

11. Place the digital scanner in the cup.

12. Position the paper so that it touches the Document Capture Base. The paper should align left and right with the matching guides on the arms of the base to ensure the document is in the correct field of view.

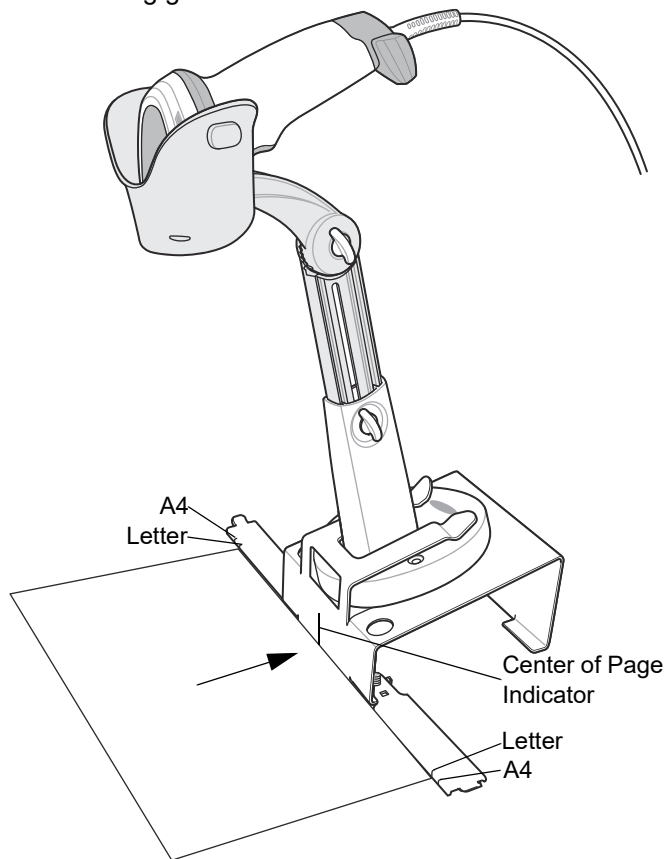

Figure 3-16 *Aligning the Paper*

✓ **NOTE** Ensure to line up the edges of the paper with the marks on the document guides, if appropriate.

13. To initiate an image capture or document capture session see [Chapter 11, Image Capture Preferences](#) or [Chapter 14, Intelligent Document Capture](#).

Electronic Article Surveillance (EAS)

✓ **NOTE** EAS is available only on scanner models that support Checkpoint EAS.

Some scanner configurations include an integrated Electronic Article Surveillance (EAS) antenna.

The scanner's integrated EAS deactivation antenna requires an EAS host cable. This Y-cable connects to the scanner's host port at one end, and splits to the host and the EAS system at the other end.

Installing

Checkpoint EAS Model Compatibility

The scanner is intended for use with Checkpoint CP-VII, CP-IX, and CP-XI systems. It does not support CP-IV and other low-power receiver-based EAS deactivation systems.

Considerations

The Checkpoint CP-VII system generates a periodic burst of electromagnetic energy that deactivates EAS tags brought near the scanner. To avoid interference with the scanner's operation, take the following precautions when installing the EAS system:

- Position the EAS antenna box as far as possible from the scanner (at least 6 in. / 15.24 cm.)
- Position the EAS antenna, EAS antenna box, EAS control cable, and EAS controller box as far as possible from the scanner's host and power cables.

EAS range is as dependent on the Checkpoint system (which is calibrated onsite) as it is on the scanner. Therefore, we cannot provide estimated ranges, however these are some of the factors that contribute to EAS range:

- Antenna – Length, gauge, number of turns, placement in the scanner
- Type of Checkpoint EAS system used (ie. CP-VII, CP-IX, and CP-XI)
- Length of wire connecting antenna to (Checkpoint) EAS (site/installation dependent)
- Settings done within Checkpoint system (site/installation dependent).

Checkpoint Contact Information

Contact your local Checkpoint representative to install the EAS cable to the Checkpoint Deactivation System.

CHAPTER 4 MAINTENANCE, TROUBLESHOOTING, & TECHNICAL SPECIFICATIONS

Introduction

This chapter provides suggested digital scanner maintenance, troubleshooting, technical specifications, and signal descriptions (pinouts).

Maintenance



IMPORTANT Use pre-moistened wipes and do not allow liquid cleaner to pool.

¹ Ensure the following items are addressed when using sodium hypochlorite (bleach) based cleaners:

- For scanner only.
- Always follow the manufacturer's recommended instructions: use gloves during application and remove the residue afterwards with a damp cloth to avoid prolonged skin contact while handling the scanner.
- Due to the powerful oxidizing nature of sodium hypochlorite, the metal surfaces, including electrical contacts on the scanner, are prone to oxidation (corrosion) when exposed to this chemical in the liquid form (including wipes) and should be avoided. In the event that these type of disinfectants come in contact with metal on the scanner, prompt removal with a dampened cloth after the cleaning step is critical.



IMPORTANT To avoid damage to the device, use only approved cleaning and disinfecting agents listed below. The use of non-approved cleaning or disinfecting agents may void the warranty.

Known Harmful Ingredients

The following chemicals are known to damage the plastics on Zebra scanners and should not come in contact with the device:

- Acetone
- Ammonia solutions
- Aqueous or alcoholic alkaline solutions
- Aromatic and chlorinated hydrocarbons
- Benzene
- Carboic acid
- Compounds of amines or ammonia
- Ethanolamine
- Ethers
- Ketones
- TB-lysoform
- Toluene
- Trichloroethylene.

Approved Cleaners for Standard DS8108 Digital Scanners

- Isopropyl alcohol 70% (including wipes)
- 10% Bleach (Sodium Hypochlorite 0.55%) and 90% Water solution ¹ (see important notes on [page 4-1](#))
- 3% Hydrogen Peroxide and 97% Water solution
- Mild dish soap.

Approved Disinfectant Cleaners for Healthcare Configurations of the DS8108 Digital Scanners

- 10% Bleach (Sodium Hypochlorite 0.55%) and 90% Water solution ¹ (see important note on [page 4-1](#))
- 3% Hydrogen Peroxide and 97% Water solution
- 91% Isopropyl Alcohol and 9% Water solution
- Azowipe
- Brulin BruTab 6S Tablets ¹ (see important notes on [page 4-1](#))
- Clinell Universal Sanitizing Wipes
- Clinell Universal Wipes
- Clorox Dispatch Hospital Cleaner Disinfectant Towels with Bleach ¹ (see important notes on [page 4-1](#))
- Clorox Formula 409 Glass and Surface Cleaner
- Clorox Healthcare Bleach Germicidal Wipes ¹ (see important notes on [page 4-1](#))
- Clorox Healthcare Hydrogen Peroxide Wipes
- Clorox Healthcare Multi-Surface Quat Alcohol Wipes
- Diversey D10 Concentrate Detergent Sanitizer
- Diversey Dimension 256 Neutral Disinfectant Cleaner
- Diversey Oxivir Tb Wipes

- Diversey Virex II 256 One-Step Disinfectant Cleaner
- Medipal Alcohol Wipes
- Metrex CaviCide
- Metrex CaviCide 1
- Metrex CaviWipes
- Metrex CaviWipes 1
- PDI Easy Screen® Cleaning Wipe
- PDI Sani-Cloth AF3 Germicidal Disposable Wipe
- PDI Sani-Cloth Bleach Germicidal Disposable Wipe ¹ (see important notes on [page 4-1](#))
- PDI Sani-Cloth HB Sani-Germicidal Disposable Wipe
- PDI Sani-Cloth Plus Germicidal Disposable Cloth
- PDI Super Sani-Cloth Germicidal Wipe
- Progressive Products Wipes Plus
- Sani Professional Disinfecting Multi-Surface Wipes
- Sani-Hands® Instant Hand Sanitizing Wipes
- SC Johnson Windex Original Glass Cleaner with Ammonia-D
- Spartan Hepacide Quat II
- Sterets Alcowipe
- Steris Coverage Plus Germicidal
- Veridien Viraguard
- WipesPlus Hospital/Surgical Wipes.

Cleaning the Digital Scanner

Routinely cleaning the exit window is required. A dirty window may affect scanning accuracy. Do not allow any abrasive material to touch the window.

To clean the scanner:

1. Dampen a soft cloth with one of the approved cleaning agents listed above or use pre-moistened wipes.
2. Gently wipe all surfaces, including the front, back, sides, top and bottom. Never apply liquid directly to the scanner. Be careful not to let liquid pool around the scanner window, trigger, cable connector or any other area on the device.
3. Be sure to clean the trigger and in between the trigger and the housing (use a cotton-tipped applicator to reach tight or inaccessible areas).
4. Do not spray water or other cleaning liquids directly into the exit window.
5. Wipe the scanner exit window with a lens tissue or other material suitable for cleaning optical material such as eyeglasses.
6. Immediately dry the scanner window after cleaning with a soft non-abrasive cloth to prevent streaking.

7. Allow the unit to air dry before use.
8. Scanner connectors:
 - a. Dip the cotton portion of a cotton-tipped applicator in isopropyl alcohol.
 - b. Rub the cotton portion of the cotton-tipped applicator back-and-forth across the connector on the Zebra scanner at least 3 times. Do not leave any cotton residue on the connector.
 - c. Use the cotton-tipped applicator dipped in alcohol to remove any grease and dirt near the connector area.
 - d. Use a dry cotton tipped applicator and rub the cotton portion of the cotton-tipped applicator back-and-forth across the connectors at least 3 times. Do not leave any cotton residue on the connectors.

Troubleshooting

Table 4-1 *Troubleshooting*

Problem	Possible Causes	Possible Solutions
The aiming pattern does not appear when pressing the trigger.	No power to the digital scanner.	If the configuration requires a power supply, re-connect the power supply.
	Incorrect host interface cable is used.	Connect the correct host interface cable.
	Interface/power cables are loose.	Re-connect cables.
	Digital scanner is disabled.	For IBM 468x and USB IBM hand-held, IBM table-top, and OPOS modes, enable the digital scanner via the host interface. Otherwise, see the technical person in charge of scanning.
	If using RS-232 Nixdorf B mode, CTS is not asserted.	Assert CTS line.
	Aiming pattern is disabled.	Enable the aiming pattern. See <i>Hand-held Decode Aiming Pattern</i> on page 10-23.
Digital scanner emits aiming pattern, but does not decode the bar code.	Digital scanner is not programmed for the correct bar code type.	Program the digital scanner to read that type of bar code. See Chapter 12, Symbologies .
	Bar code symbol is unreadable.	Scan test symbols of the same bar code type to determine if the bar code is defaced.
	The symbol is not completely inside aiming pattern.	Move the symbol completely within the aiming pattern. Move the symbol completely within the field of view (AIM pattern does NOT define FOV)
	Distance between digital scanner and bar code is incorrect.	Move the scanner closer to or further from the bar code. See <i>Decode Ranges</i> on page 3-9.
Digital scanner decodes bar code, but does not transmit the data to the host.	Digital scanner is not programmed for the correct host type.	Scan the appropriate host type programming bar code. See the chapter corresponding to the host type.
	Interface cable is loose.	Re-connect the cable.
	If the digital scanner emits four long low beeps, a transmission error occurred. This occurs if a unit is not properly configured or connected to the wrong host type.	Set the scanner's communication parameters to match the host's setting.
	If the digital scanner emits 5 low beeps, a conversion or format error occurred.	Configure the digital scanner's conversion parameters properly.
	If the digital scanner emits low/high/low beeps, it detected an invalid ADF rule.	Program the correct ADF rules. Refer to the <i>Advanced Data Formatting Programmer Guide</i> .

Table 4-1 Troubleshooting (Continued)

Problem	Possible Causes	Possible Solutions
Host displays scanned data incorrectly.	Digital scanner is not programmed to work with the host.	Scan the appropriate host type programming bar code.
		For RS-232, set the digital scanner's communication parameters to match the host's settings.
		For a Keyboard Wedge configuration, program the system for the correct keyboard type, and turn off the CAPS LOCK key.
		Program the proper editing options (e.g., UPC-E to UPC-A Conversion).
Digital scanner emits short low/short medium/short high beep sequence (power-up beep sequence) more than once.	The USB bus may put the digital scanner in a state where power to the scanner is cycled on and off more than once.	Normal during host reset.
Digital scanner emits 4 short high beeps during decode attempt.	Digital scanner has not completed USB initialization.	Wait several seconds and scan again.
Digital scanner emits Low/low/low/extra low beeps when not in use.	RS-232 receive error.	Normal during host reset. Otherwise, set the digital scanner's RS-232 parity to match the host setting.
Digital scanner emits low/high beeps during programming.	Input error, incorrect bar code or Cancel bar code was scanned.	Scan the correct numeric bar codes within range for the parameter programmed.
Digital scanner emits low/high/low/high beeps during programming.	Out of host parameter storage space.	Scan <i>Default Parameters on page 10-5</i> .
	Out of memory for ADF rules.	Reduce the number of ADF rules or the number of steps in the ADF rules.
	During programming, indicates out of ADF parameter storage space.	Erase all rules and re-program with shorter rules.
Digital scanner emits low/high/low beeps.	ADF transmit error.	Refer to the Advanced Data Formatting Guide for information.
	Invalid ADF rule is detected.	Refer to the Advanced Data Formatting Guide for information.
Digital scanner emits a power-up beep after changing USB host type.	The USB bus re-established power to the digital scanner.	Normal when changing USB host type.
Digital scanner emits one high beep when not in use.	In RS-232 mode, a <BEL> character was received and Beep on <BEL> option is enabled.	Normal when Beep on <BEL> is enabled and the digital scanner is in RS-232 mode.

Table 4-1 Troubleshooting (Continued)

Problem	Possible Causes	Possible Solutions
Digital scanner emits frequent beeps.	No power to the scanner.	Check the system power. If the configuration requires a power supply, re-connect the power supply.
	Incorrect host interface cable is used.	Verify that the correct host interface cable is used. If not, connect the correct host interface cable.
	Interface/power cables are loose.	Check for loose cable connections and re-connect cables.
Digital scanner emits five long low beeps after a bar code is decoded.	Conversion or format error was detected. The scanner conversion parameters are not properly configured.	Ensure the scanner conversion parameters are properly configured.
	Conversion or format error was detected. An ADF rule was set up with characters that can't be sent for the host selected.	Change the ADF rule, or change to a host that can support the ADF rule.
	Conversion or format error was detected. A bar code was scanned with characters that can't be sent for that host.	Change the bar code, or change to a host that can support the bar code.

✓ **NOTE** If after performing these checks the digital scanner still experiences problems, contact the distributor or call support.

Dump Scanner Parameters

To debug a scanner issue, scan the following bar code with the scanner connected in USB HID keyboard mode to Microsoft® Windows Notepad or Wordpad, or via RS-232 to Windows Hyperterminal. This outputs all the scanner's asset tracking information and parameter settings to a text document.

Refer to the parameter numbers in [Appendix A, Standard Parameter Defaults](#) to interpret the parameter/attribute numbers in the output.

✓ **NOTE** Use 123Scan if available as an alternative to using this feature. 123Scan is the preferable method for outputting scanner information.

✓ **NOTE** For proper formatting, it may be necessary to first scan <DATA> <SUFFIX 1> (1) on page 10-37.

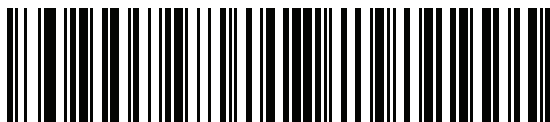

Dump Scanner Parameters

Send Versions

Report Software Version

Scan the following bar code to send the version of software installed in the scanner.

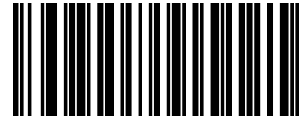

Report Software Version

Serial Number

Scan the following bar code to send the scanner serial number to the host.

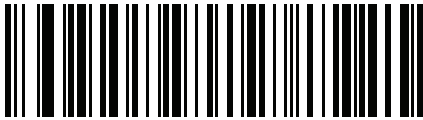

Serial Number

Manufacturing Information

Scan the following bar code to send the scanner manufacturing information to the host.



Manufacturing Information

Technical Specifications

Table 4-2 *Technical Specifications*

Item	Description						
Physical Characteristics							
Dimensions	6.6 in. H x 2.6 in. W x 4.2 in. D 16.8 cm. H x 6.6 cm. W x 10.7 cm. D						
Weight	<table border="0"> <tr> <td data-bbox="548 699 735 730">DS8108-SR/DL</td> <td data-bbox="756 699 906 730">5.4 oz./154 g</td> </tr> <tr> <td data-bbox="581 737 735 768">DS8108-HC</td> <td data-bbox="756 737 906 768">5.5 oz./156 g</td> </tr> </table>	DS8108-SR/DL	5.4 oz./154 g	DS8108-HC	5.5 oz./156 g		
DS8108-SR/DL	5.4 oz./154 g						
DS8108-HC	5.5 oz./156 g						
Available Colors	Twilight Black, Nova White, Healthcare White (DS8108-HC)						
Power	<table border="0"> <tr> <td data-bbox="589 884 735 915">DS8108-SR</td> <td data-bbox="756 884 1219 915">5 VDC +/- 10% @ 470 mA (RMS typical)</td> </tr> <tr> <td data-bbox="589 921 735 953">DS8108-HC</td> <td data-bbox="756 921 1219 953">5 VDC +/- 10% @ 470 mA (RMS typical)</td> </tr> <tr> <td data-bbox="589 959 735 991">DS8108-DL</td> <td data-bbox="756 959 1219 991">5 VDC +/- 10% @ 470 mA (RMS typical)</td> </tr> </table>	DS8108-SR	5 VDC +/- 10% @ 470 mA (RMS typical)	DS8108-HC	5 VDC +/- 10% @ 470 mA (RMS typical)	DS8108-DL	5 VDC +/- 10% @ 470 mA (RMS typical)
DS8108-SR	5 VDC +/- 10% @ 470 mA (RMS typical)						
DS8108-HC	5 VDC +/- 10% @ 470 mA (RMS typical)						
DS8108-DL	5 VDC +/- 10% @ 470 mA (RMS typical)						
Supported Host Interfaces	USB, RS232, Keyboard Wedge, TGCS (IBM) 46XX over RS485						
USB Certification	DS8108 is USB2.0 Full Speed Compliant, visit USB.org for more details.						
Keyboard Support	Supports over 90 international keyboards						
FIPS Security Certification	Certified Compliant with FIPS 140-2						
User Indicators	Direct Decode Indicator, Good Decode LEDs, Rear View LEDs, Beeper (Adjustable Tone & Volume), Battery Indicator						
Performance Characteristics							
Light Source	<table border="0"> <tr> <td data-bbox="589 1434 735 1465">DS8108-SR</td> <td data-bbox="756 1434 1401 1465">Aiming pattern: 617 nm LED / Illumination: 660 nm LEDs</td> </tr> <tr> <td data-bbox="589 1472 735 1503">DS8108-HC</td> <td data-bbox="756 1472 1446 1503">Aiming pattern: 528 nm LED/ Illumination: Warm white LEDs</td> </tr> <tr> <td data-bbox="589 1509 735 1541">DS8108-DL</td> <td data-bbox="756 1509 1401 1541">Aiming pattern: 617 nm LED / Illumination: 660 nm LEDs</td> </tr> </table>	DS8108-SR	Aiming pattern: 617 nm LED / Illumination: 660 nm LEDs	DS8108-HC	Aiming pattern: 528 nm LED/ Illumination: Warm white LEDs	DS8108-DL	Aiming pattern: 617 nm LED / Illumination: 660 nm LEDs
DS8108-SR	Aiming pattern: 617 nm LED / Illumination: 660 nm LEDs						
DS8108-HC	Aiming pattern: 528 nm LED/ Illumination: Warm white LEDs						
DS8108-DL	Aiming pattern: 617 nm LED / Illumination: 660 nm LEDs						
Illumination	<table border="0"> <tr> <td data-bbox="548 1602 735 1633">DS8108-SR/DL</td> <td data-bbox="756 1602 1011 1633">Two 645nm red LEDs</td> </tr> <tr> <td data-bbox="589 1640 735 1671">DS8108-HC</td> <td data-bbox="756 1640 1011 1671">Two warm white LEDs</td> </tr> </table>	DS8108-SR/DL	Two 645nm red LEDs	DS8108-HC	Two warm white LEDs		
DS8108-SR/DL	Two 645nm red LEDs						
DS8108-HC	Two warm white LEDs						
Field of View (Horizontal x Vertical) Nominal	48° H x 37° V						
Image Sensor	1,280 x 960 pixels						
Minimum Print Contrast	16% minimum reflective difference						
Skew Tolerance	+/- 60°						
Pitch Tolerance	+/- 60°						

Table 4-2 *Technical Specifications (Continued)*

Item	Description
Roll Tolerance	0-360°
Image Capture	
Graphics Format Support	Images can be exported as Bitmap, JPEG, or TIFF
Resolution (A4 document)	109 PPI
Minimum Element Resolution	Code 39 - 3.0 mil; Code 128 - 3.0 mil; Data Matrix - 6.0 mil; QR Code - 6.0 mil; PDF - 5.0 mil
User Environment	
DS8108-SR/DL Temperatures	Operating Temperature: 32° to 122°F / 0° to 50°C
Storage Temperature	-40° to 158°F / -40° to 70°C
Humidity	5% to 95% RH, non-condensing
Drop Specification (Scanner)	Designed to withstand multiple drops at 6.0 ft./1.8 m to concrete
Tumble Specification (Scanner)	Designed to withstand 2,000 tumbles in 1.5 ft./0.5 m tumbler Note: 1 tumble = 0.5 cycle
Ambient Light Immunity	0 to 9000 Foot Candles/0 to 96,840 Lux
Environmental Sealing	Scanner rated IP42
Electrostatic Discharge (ESD)	ESD per EN61000-4-2, +/-15 KV Air, +/-8 KV Direct, +/-8 KV Indirect
Accessories - see <i>Related Product Line Configurations/Accessories on page xxii</i>	
Symbol Decode Capability	
1D	Code 39, Code 128, Code 93, Codabar/NW7, Code 11, MSI, UPC/EAN, I 2 of 5, Korean 3 of 5, GS1 DataBar, Base 32 (Italian Pharma)
2D	PDF417, Micro PDF417, Composite Codes, TLC-39, Aztec, Data Matrix, MaxiCode, QR Code, Micro QR, Han Xin, Postal Codes
Digimarc	Digital watermark technology

Table 4-2 *Technical Specifications (Continued)*

Item	Description																		
Minimum Resolution <div style="text-align: right; margin-right: 20px;">DS8108-SR/DL</div> <div style="text-align: right; margin-right: 20px;">DS8108-HC</div>	<table style="width: 100%; border-collapse: collapse;"> <tr> <td style="width: 30%;">Code 39</td> <td style="width: 30%;">3 mil</td> </tr> <tr> <td>UPC 40%</td> <td>5.2 mil</td> </tr> <tr> <td>PDF417</td> <td>4 mil</td> </tr> <tr> <td>Data Matrix</td> <td>6 mil</td> </tr> <tr> <td colspan="2"> </td> </tr> <tr> <td>Code 39</td> <td>3 mil</td> </tr> <tr> <td>UPC 40%</td> <td>5.2 mil</td> </tr> <tr> <td>PDF417</td> <td>4 mil</td> </tr> <tr> <td>Data Matrix</td> <td>5 mil</td> </tr> </table> <p>See <i>Decode Ranges</i> on page 3-9 for typical working ranges.</p>	Code 39	3 mil	UPC 40%	5.2 mil	PDF417	4 mil	Data Matrix	6 mil			Code 39	3 mil	UPC 40%	5.2 mil	PDF417	4 mil	Data Matrix	5 mil
Code 39	3 mil																		
UPC 40%	5.2 mil																		
PDF417	4 mil																		
Data Matrix	6 mil																		
Code 39	3 mil																		
UPC 40%	5.2 mil																		
PDF417	4 mil																		
Data Matrix	5 mil																		
Utilities and Management																			
123Scan	Programs scanner parameters, upgrades firmware, provides scanned bar code data and prints reports. See Chapter 2, 123Scan and Software Tools .																		
Symbol Scanner SDK	Generates a fully-featured scanner application, including documentation, drivers, test utilities and sample source code. zebra.com/ScannerSDKforWindows																		
Scanner Management Service (SMS)	Remotely manages your Zebra scanner and queries its asset information. zebra.com/sms																		

Digital Scanner Signal Descriptions

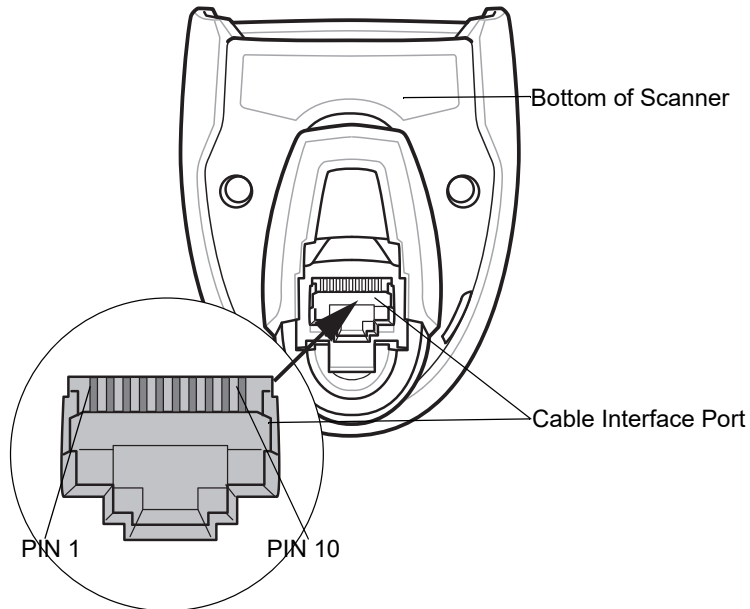

Figure 4-1 Digital Scanner Cable Pin-outs

The signal descriptions in [Table 4-3](#) apply to the connectors on the DS8108 digital scanner and are for reference only.

Table 4-3 DS8108 Digital Scanner Signal Pin-outs

Pin	IBM	RS-232	Keyboard Wedge	USB
1	Cable ID	Cable ID	Cable ID	Cable ID
2	Power (+5V)	Power (+5V)	Power (+5V)	Power (+5V)
3	Ground	Ground	Ground	Ground
4	IBM_OUT	TxD	KeyClock	Reserved
5	IBM_IN	RxD	TermData	D +
6	IBM_T/R	RTS	KeyData	Reserved
7	Reserved	CTS	TermClock	D -
8	Reserved	Reserved	Reserved	Reserved
9	See note			
10	See note			

Note: EAS configurations use pins 9 and 10 for an EAS antenna. For other configurations pins 9 and 10 are open.

CHAPTER 5 USB INTERFACE

Introduction

This chapter describes how to set up the scanner with a USB host. The scanner connects directly to a USB host, or a powered USB hub, which powers it. No additional power supply is required.

The scanner ships with the settings shown in [Table 5-1 on page 5-4](#) (also see [Appendix A, Standard Parameter Defaults](#) for all defaults). If the default values suit requirements, programming is not necessary.

Setting Parameters

To set feature values, scan a single bar code or a short bar code sequence. The settings are stored in non-volatile memory and are preserved even when the scanner powers down.

✓ **NOTE** Most computer monitors allow scanning bar codes directly on the screen. When scanning from the screen, be sure to set the document magnification to a level where you can see the bar code clearly, and bars and/or spaces do not merge.

To return all features to default values, scan *Set Factory Defaults on page 10-5*. Throughout the programming bar code menus, asterisks (*) indicate default values.

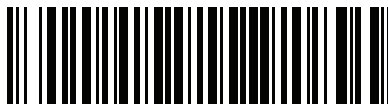

* Indicates default * Enable Parameter Feature/option

Scanning Sequence Examples

In most cases scanning one bar code sets the parameter value. For example, to set the USB keystroke delay to medium, scan the **Medium Delay (20 msec)** bar code under *USB Keystroke Delay on page 5-8*. The scanner issues a fast warble beep and the LED turns green, signifying a successful parameter entry.

Other parameters require scanning several bar codes. See the parameter descriptions for this procedure.

Errors While Scanning

Unless otherwise specified, to correct an error during a scanning sequence, just re-scan the correct parameter.

Connecting a USB Interface

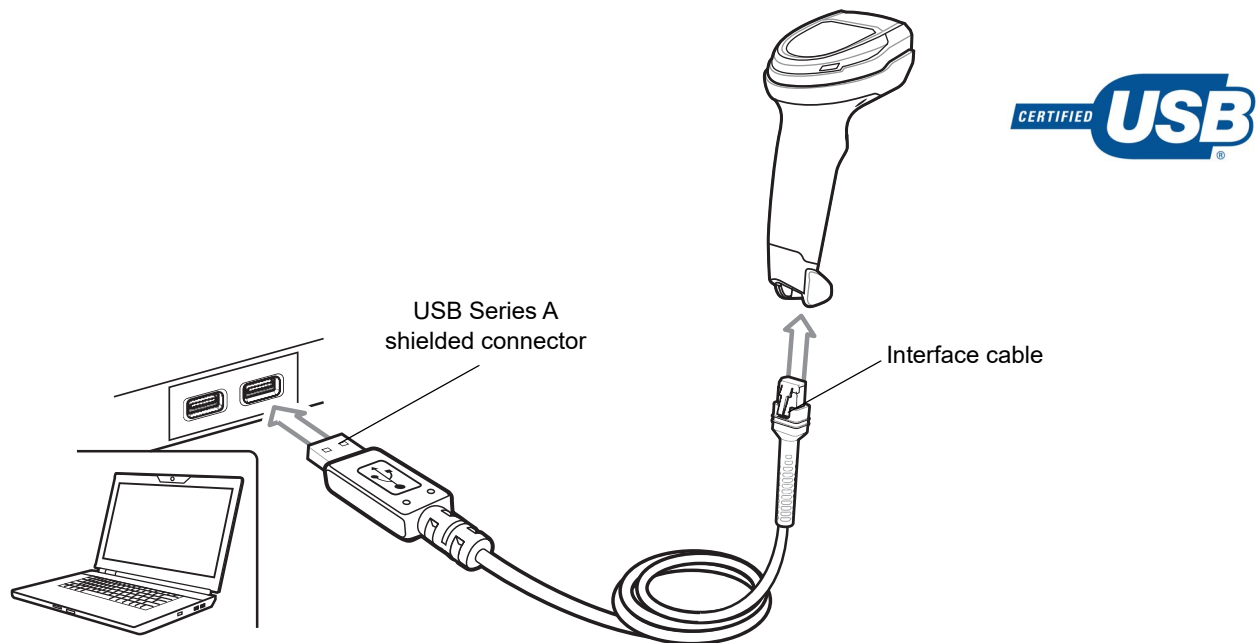

Figure 5-1 *USB Connection.*

✓ **NOTE** When connecting via USB use the shielded connector cable (e.g., p/n CBA-U21-S07ZAR). Refer to Solution Builder for guidance about cables.

The scanner connects to USB-capable hosts including:

- Apple™ desktop and notebooks
- Other network computers that support more than one keyboard.

The following operating systems support the scanner through USB:

- Windows® XP, 7, 8, 10
- MacOS 8.5 - MacOS 10.6
- IBM 4690 OS
- Linux.

The scanner also interfaces with other USB hosts that support USB Human Interface Devices (HID).

To set up the scanner:

✓ **NOTE** Interface cables vary depending on configuration. The connectors illustrated in [Figure 5-1](#) are examples only. The connectors may be different than those illustrated, but the steps to connect the scanner are the same.

1. Connect the modular connector of the USB interface cable to the cable interface port on the scanner. See [Installing the Interface Cable on page 1-3](#).
2. Plug the series A connector in the USB host or hub, or plug the Plus Power connector in an available port of the IBM SurePOS terminal.
3. The scanner automatically detects the host and uses the default USB device type. If the default (*) does not meet your requirements, select another USB device type by scanning the appropriate bar code from *USB Device Type* on page 5-6.
4. On first installation when using Windows, the software may prompt to select or install the Human Interface Device driver. To install this driver, provided by Windows, click **Next** at all choices and click **Finished** on the last choice. The scanner powers up during this installation.
5. To modify any other parameter options, scan the appropriate bar codes in this chapter.

If problems occur with the system, see [Troubleshooting on page 4-5](#).

USB Parameter Defaults

[Table 5-1](#) lists defaults for USB host parameters. Change these values in one of two ways:

- Scan the appropriate bar codes in this chapter. The new value replaces the standard default value in memory. To recall default parameter values, see *Default Parameters on page 10-5*.
- Configure the scanner using the 123Scan configuration program. See [Chapter 2, 123Scan and Software Tools](#).

✓ **NOTE** See [Appendix A, Standard Parameter Defaults](#) for all user preference, host, symbology, and miscellaneous default parameters.

Table 5-1 USB Interface Parameter Defaults

Parameter	Default	Page Number
USB Host Parameters		
USB Device Type	USB Keyboard HID	5-6
Symbol Native API (SNAPI) Status Handshaking	Enable	5-8
USB Keystroke Delay	No Delay	5-8
USB Caps Lock Override	Disable	5-9
Bar Codes with Unknown Characters	Send Bar Codes with Unknown Characters	5-9
USB Convert Unknown to Code 39	Disable	5-10
USB Fast HID	Enable	5-11
USB Polling Interval	3 msec	5-12
Keypad Emulation	Enable	5-14
Quick Keypad Emulation	Enable	5-14
Keypad Emulation with Leading Zero	Enable	5-15
USB FN1 Substitution	Disable	5-15
Function Key Mapping	Disable	5-16
Simulated Caps Lock	Disable	5-16
Convert Case	None	5-17
USB Static CDC	Enable	5-17
USB CDC Host Variant	CDC Standard	5-18
TGCS (IBM) USB Direct I/O Beep	Honor	5-21
TGCS (IBM) USB Beep Directive	Ignore	5-21

Table 5-1 *USB Interface Parameter Defaults (Continued)*

Parameter	Default	Page Number
TGCS (IBM) USB Bar Code Configuration Directive	Ignore	5-22
TGCS (IBM) USB Specification Version	Version 2.2	5-22

USB Host Parameters

USB Device Type

Scan one of the following bar codes to select the USB device type. To select a country keyboard type for the **USB Keyboard HID** host, see [Appendix G, Country Codes](#)..



NOTES

1. When changing USB Device Types, the scanner resets and issues the standard startup beep sequences.
2. When connecting two scanners to a host, IBM does not allow selecting two of the same device type. If you require two connections, select IBM Table-top USB for one scanner and IBM Hand-held USB for the second scanner.
3. Select **IBM Hand-held USB** to disable data transmission when an IBM register issues a Scan Disable command. Aim, illumination, and decoding is still permitted. Select **IBM OPOS (IBM Hand-held USB with Full Scan Disable)** to completely shut off the scanner when an IBM register issues a Scan Disable command, including aim, illumination, decoding, and data transmission.
4. To select the Toshiba TEC device type, refer to the *Toshiba TEC Programmer's Guide*.

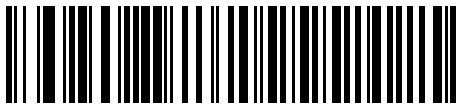

***USB Keyboard HID**



IBM Table-top USB

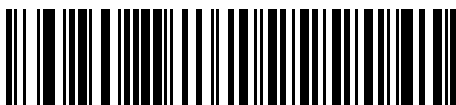

IBM Hand-held USB



**IBM OPOS
(IBM Hand-held USB with Full Scan Disable)**

**NOTES**

5. Before selecting *USB CDC Host* on page 5-7 or *SSI over USB CDC* on page 5-7, install the appropriate USB CDC Driver on the host to ensure the scanner does not stall during power up (due to a failure to enumerate USB). Go to zebra.com/support, Support & Downloads > Barcode Scanners > USB CDC Driver, select the appropriate Windows platform, and download the appropriate CDC Driver (64 bit or 32 bit).
To recover a stalled scanner:
Install the USB CDC Driver
or
After power-up, hold the trigger for 10 seconds, which allows the scanner to power up using an alternate USB configuration. Upon power-up, scan another **USB Device Type**.
6. Select **USB HID POS** to communicate over a USB cable with Universal Windows Platform (UWP) applications running on Windows 10 devices.

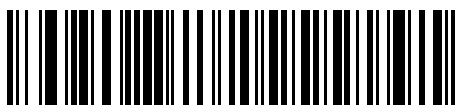
**USB CDC Host****SSI over USB CDC****Symbol Native API (SNAPI) with Imaging Interface****Symbol Native API (SNAPI) without Imaging Interface****USB HID POS**
(for Windows 10 devices only)

Symbol Native API (SNAPI) Status Handshaking

After selecting a SNAPI interface as the USB device type, scan one of the following bar codes to select whether to enable or disable status handshaking.



***Enable SNAPI Status Handshaking**



Disable SNAPI Status Handshaking

USB Keystroke Delay

Scan one of the following bar codes to set the delay, in milliseconds, between emulated keystrokes. Select a longer delay for hosts that require slower data transmission.

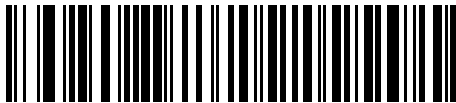

***No Delay**



Medium Delay (20 msec)

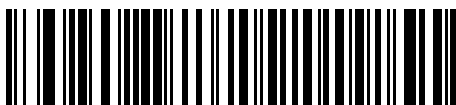

Long Delay (40 msec)

USB Caps Lock Override

This option applies only to the USB Keyboard HID device. Scan **Override Caps Lock Key** to preserve the case of the data regardless of the state of the **Caps Lock** key. This setting is always enabled for the Japanese Windows (ASCII) keyboard type and can not be disabled.

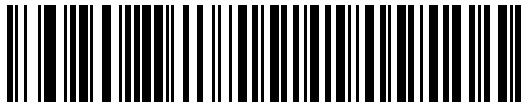

**Override Caps Lock Key
(Enable)**



***Do Not Override Caps Lock Key
(Disable)**

Bar Codes with Unknown Characters

This option applies only to the USB Keyboard HID and IBM devices. Unknown characters are characters the host does not recognize. Scan **Send Bar Codes With Unknown Characters** to send all bar code data except for unknown characters. The scanner issues no error beeps.

Scan **Do Not Send Bar Codes With Unknown Characters** for IBM devices to prevent sending bar codes containing at least one unknown character to the host, or for USB Keyboard HID devices to send the bar code characters up to the unknown character. The scanner issues an error beep.

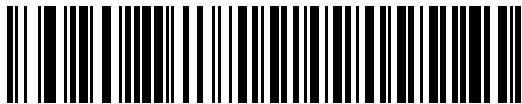

***Send Bar Codes with Unknown Characters**



Do Not Send Bar Codes with Unknown Characters

USB Convert Unknown to Code 39

This option applies only to the IBM hand-held, IBM table-top, and OPOS devices. Scan one of the following bar codes to enable or disable converting unknown bar code type data to Code 39.

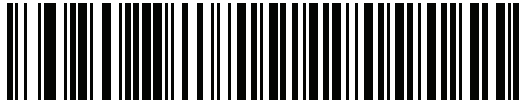

Enable Convert Unknown to Code 39



***Disable Convert Unknown to Code 39**

USB Fast HID

Scan **Enable USB Fast HID** to transmit USB HID data at a faster rate.



NOTE Disable this if there are problems with transmission.

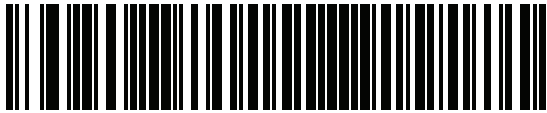

***Enable USB Fast HID**

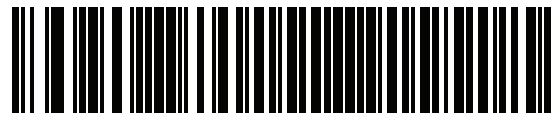

Disable USB Fast HID

USB Polling Interval

Scan one of the following bar codes to set the polling interval, which is the rate at which data transmits between the scanner and host computer. A lower number indicates a faster data rate.



NOTE When changing the USB polling interval, the scanner restarts and issues a power-up beep sequence.



IMPORTANT Ensure the host supports the selected data rate.



1 msec

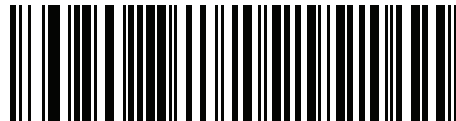

2 msec

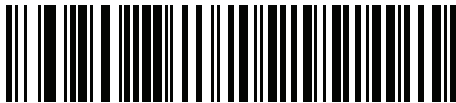

*3 msec



4 msec

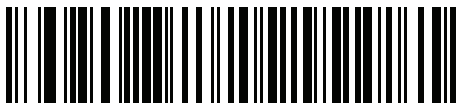

5 msec

USB Polling Interval (continued)



6 msec

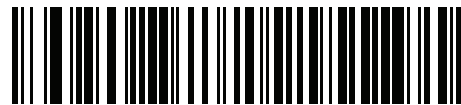

7 msec

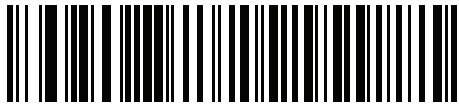

8 msec

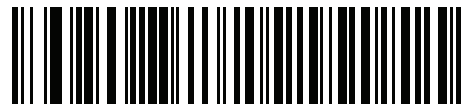

9 msec

Keypad Emulation

Scan **Enable Keypad Emulation** to send all characters as ASCII sequences over the numeric keypad. For example, ASCII A transmits as “ALT make” 0 6 5 “ALT Break”.

✓ **NOTE** If your keyboard type is not listed in the country code list (see *Country Codes on page G-1*), disable *Quick Keypad Emulation* and enable **Keypad Emulation**.

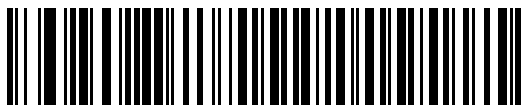

***Enable Keypad Emulation**



Disable Keypad Emulation

Quick Keypad Emulation

This option applies only to the USB Keyboard HID device when *Keypad Emulation* is enabled. Scan **Enable Quick Keypad Emulation** for a quicker method of emulation using the numeric keypad where ASCII sequences are only sent for ASCII characters not found on the keyboard.



***Enable Quick Keypad Emulation**



Disable Quick Keypad Emulation

Keypad Emulation with Leading Zero

Scan **Enable Keypad Emulation with Leading Zero** to send character sequences sent over the numeric keypad as ISO characters which have a leading zero. For example, ASCII A transmits as "ALT MAKE" 0 0 6 5 "ALT BREAK".



***Enable Keypad Emulation with Leading Zero**



Disable Keypad Emulation with Leading Zero

USB Keyboard FN1 Substitution

This option applies only to the USB Keyboard HID device. Scan **Enable USB Keyboard FN1 Substitution** to replace any FN1 character in a GS1 128 bar code with a user-selected Key Category and value. See *FN1 Substitution Values on page 10-39* to set the Key Category and Key Value.

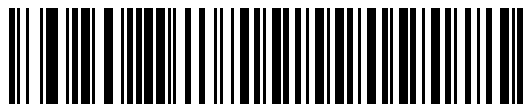

Enable USB Keyboard FN1 Substitution

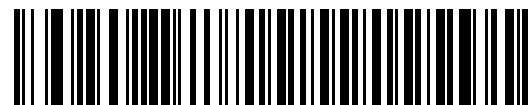

***Disable USB Keyboard FN1 Substitution**

Function Key Mapping

ASCII values under 32 are normally sent as a control-key sequence (see [Table D-1 on page D-1](#)). Scan **Enable Function Key Mapping** to send the keys in bold in place of the standard key mapping. Table entries that do not have a bold equivalent remain the same regardless of whether you enable this parameter.



Enable Function Key Mapping



***Disable Function Key Mapping**

Simulated Caps Lock

Scan **Enable Simulated Caps Lock** to invert upper and lower case characters on the bar code as if the Caps Lock state is enabled on the keyboard. This inversion occurs regardless of the keyboard's **Caps Lock** state.

- ✓ **NOTE** Simulated Caps Lock applies to ASCII characters only.
- ✓ **NOTE** Do not enable this if *USB Caps Lock Override on page 5-9* is enabled.

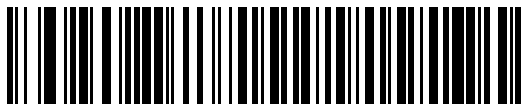

Enable Simulated Caps Lock



***Disable Simulated Caps Lock**

Convert Case

Scan one of the following bar codes to convert all bar code data to the selected case.

✓ **NOTE** Convert Case applies to ASCII characters only.

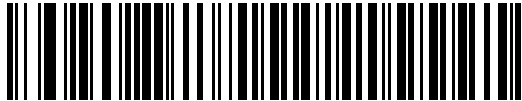

***No Case Conversion**

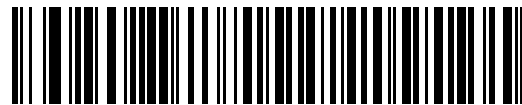

Convert All to Upper Case

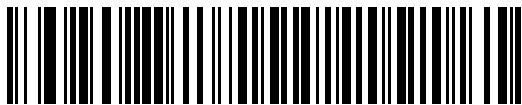

Convert All to Lower Case

USB Static CDC

When disabled, each device connected consumes another COM port (first device = COM1, second device = COM2, third device = COM3, etc.)

When enabled, each device connects to the same COM port.



***Enable USB Static CDC**



Disable USB Static CDC

USB CDC Host Variant

Parameter # 1713

When *USB Device Type* on page 5-6 is set to *USB CDC Host*, the CDC Host Variant selects which type of CDC variant is used. The default USB CDC host variant is Standard CDC Host Mode.

The USB Airline/Airport (CUTE/CUSS/CUPS) CDC host variant feature mimics the RS-232 host variant (CUTE) feature and is supported over USB CDC host mode. The scanner transmits data in Airline/Airport (CUTE/CUSS/CUPS) data format <Prefix><Data><Suffix>.

The USB Airline/Airport (CUTE/CUSS/CUPS) feature supports two CDC host variants; one for each Independent Software Vendor (ISV) specification (namely, STIA and ARINC).

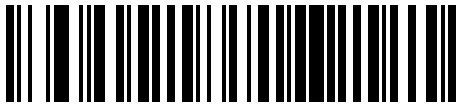

*CDC Standard

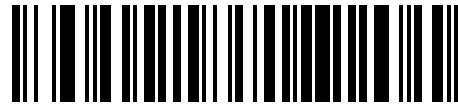

CDC SITA



CDC ARINC

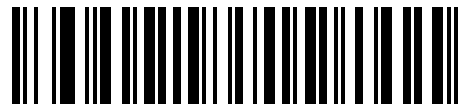

Datalogic USB CDC Host Variant

Lockout of Parameter Bar Code Scanning

If the scanner is configured as USB CDC Host Variant (other than CDC Standard), it disables all parameter bar code scanning. The user can unlock it by scanning **Enable Parameter Bar Code Scanning** on [page 10-6](#).

Parameter Default

Enabling of any of the USB CDC Host Variants (other than CDC Standard) requires coercion of other parameters. The scanner updates the parameters in [Table 5-2](#) to the specified default values based on the USB CDC Host Variant selected.

Table 5-2 Parameter Default for Airport Device Types

Parameter	SITA Defaults	ARINC Defaults
IATA 2 of 5 (D 2 of 5)	Enabled	Enabled
Parameter Scanning	Disabled	Disabled
IATA 2 of 5 (D 2 of 5) lengths	6 to 55	6 to 55
I 2 of 5	Enabled	Enabled
I 2 of 5 lengths	4 to 56	4 to 56
Micro PDF	Enabled	N/R
PDF417	N/R	Enabled
Code39	N/R	Enabled
Code128	N/R	Enabled
Triggered Same Symbol Timeout	Enabled	Enabled
Transmit Code ID	Disabled	Disabled

Transmit Data Formatting

SITA Format

The USB SITA feature transmits data in SITA format: **<STX><ID><DATA><CR><ETX>**

Where:

<STX> - 0x02

<ID> - Custom Code ID ([Table 5-3](#))

<DATA> - Bar code decode data

<CR> - 0x0d

<ETX> - 0x03

Table 5-3 STIA Code ID

Code Type	Code ID Character
I 2 of 5	1
D 2 of 5, IATA	2
Code 39, all variants	3
Data Matrix	4
Code 128, all variants	5
PDF, all variants	6
QR Code, all variants	7
Aztec Code, all variants	8

Table 5-3 STIA Code ID (Continued)

Code Type	Code ID Character
UPCA, EAN13, all supplemental variants	A
All others	None

ARINC Format

The USB SITA transmits data in “ARINC” format: <STX><DID><DOC><BID><DATA><ETX><CRC>

Where:

<STX> - 0x02

<DID> - 0xB1 (DTYP and DNUM)

<DOC> - 0x30 (Document Identifier)

<BID> - Bar code Identifier ([Table 5-4](#))

<DATA> - Bar code decode data

<ETX> - 0x03

<CRC> - CRC-16

Table 5-4 ARINC Bar Code Identifier

Bar Code Type	ASCII Value
Interleaved 2 of 5	1
Industrial 2 of 5 (D 2 of 5)	2
Code 39	3
Code 128	5
Code 39 with check digit*	8
Industrial 2 of 5 with check digit*	9
Interleaved 2 of 5 with check digit*	0
2D Data Matrix	4
2D QR	7
2D PDF	6
EAN 13 with check digit*	A
2D Aztec	8
All others	None

* **Note:** Bar code types with check digits are currently not supported on the scanner for ARINC.

TGCS (IBM) USB Direct I/O Beep

Parameter # 1360 (SSI # 550h)

The host can send a direct I/O beep request to the scanner. If you select **Ignore Direct I/O Beep**, the scanner does not sound beeps on this command. All directives are still acknowledged to the USB host as if they were processed.



***Honor Direct IO Beep**



Ignore Direct IO Beep

TGCS (IBM) USB Beep Directive

The host can send a beeper configuration request to the scanner. Scan **Ignore Beep Directive** to prevent the scanner from processing the host request. All directives are still acknowledged to the USB host as if they were processed.



Honor Beep Directive



***Ignore Beep Directive**

TGCS (IBM) USB Bar Code Configuration Directive

The host can enable and disable code types. Scan **Ignore Bar Code Configuration Directive** to prevent the scanner from processing the host request. All directives are still acknowledged to the USB host as if they were processed.



Honor Bar Code Configuration Directive



***Ignore Bar Code Configuration Directive**

TGCS (IBM) USB Specification Version

Select **IBM Specification Level Version 0 (Original)** to send the following code types as Unknown:

- Data Matrix
- GS1 Data Matrix
- QR Code
- GS1 QR
- MicroQR Code
- Aztec

Select **IBM Specification Level Version 2.2** to send the code types with the appropriate IBM identifiers.



IBM Specification Level Version 0 (Original)



***IBM Specification Level Version 2.2**

ASCII Character Sets

See [Appendix D, ASCII Character Sets](#) for the following information:

- [Table D-1, ASCII Character Set on page D-1](#)
- [Table D-2, ALT Key Character Set on page D-6](#)
- [Table D-3, GUI Key Character Set on page D-7](#)
- [Table D-4, PF Key Character Set on page D-9](#)
- [Table D-5, F Key Character Set on page D-10](#)
- [Table D-6, Numeric Key Character Set on page D-11](#)
- [Table D-7, Extended Key Character Set on page D-12](#)

CHAPTER 6 SSI INTERFACE

Introduction

This chapter describes the system requirements of the Simple Serial Interface (SSI), which provides a communications link between Zebra decoders (e.g., scan engines, slot scanners, hand-held scanners, two-dimensional scanners, Hands-free scanners, and RF base stations) and a serial host. It provides the means for the host to control the decoder or scanner.

Communication

All communication between the scanner and host occurs over the hardware interface lines using the SSI protocol. Refer to the *Simple Serial Interface Programmer's Guide*, p/n 72E-40451-xx, for more information on SSI.

The host and the scanner exchange messages in packets. A packet is a collection of bytes framed by the proper SSI protocol formatting bytes. The maximum number of bytes per packet that the SSI protocol allows for any transaction is 257 (255 bytes + 2 byte checksum).

Depending on the configuration, the scanner can send decode data as ASCII data (unpacketed), or as part of a larger message (packeted).

SSI performs the following functions for the host device:

- Maintains a bi-directional interface with the scanner
- Allows the host to send commands that control the scanner
- Passes data from the scanner to a host device in SSI packet format or straight decode message.

The SSI environment consists of a scanner, a serial cable which attaches to the host device, and if required, a power supply.

SSI transmits all decode data including special formatting (e.g., AIM ID). Parameter settings can control the format of the transmitted data.

The scanner can also send parameter information, product identification information, or event codes to the host.

All commands sent between the scanner and host must use the format described in the SSI Message Formats section. *SSI Transactions on page 6-3* describes the required sequence of messages in specific cases.

SSI Commands

Table 6-1 lists all the SSI opcodes the scanner supports. The host transmits opcodes designated type H. The scanner (decoder) transmits type D opcodes, and either can transmit Host/Decoder (H/D) types.

Table 6-1 SSI Commands

Name	Type	Opcode	Description
AIM_OFF	H	0xC4	Deactivate aim pattern.
AIM_ON	H	0xC5	Activate aim pattern.
BEEP	H	0xE6	Sound the beeper.
CAPABILITIES_REPLY	D	0xD4	Reply to CAPABILITIES_REQUEST; contains a list of the capabilities and commands the decoder supports.
CAPABILITIES_REQUEST	H	0xD3	Request capabilities report from the decoder.
CMD_ACK	H/D	0xD0	Positive acknowledgment of received packet.
CMD_NAK	H/D	0xD1	Negative acknowledgment of received packet.
DECODE_DATA	D	0xF3	Decode data in SSI packet format.
EVENT	D	0xF6	Event indicated by associated event code.
LED_OFF	H	0xE8	De-activate LED output.
LED_ON	H	0xE7	Activate LED output.
PARAM_DEFAULTS	H	0xC8	Set parameter default values.
PARAM_REQUEST	H	0xC7	Request values of certain parameters.
PARAM_SEND	H/D	0xC6	Send parameter values.
REPLY_REVISION	D	0xA4	Reply to REQUEST_REVISION, contains the decoder's software/hardware configuration.
REQUEST_REVISION	H	0xA3	Request the decoder's configuration.
SCAN_DISABLE	H	0xEA	Prevent the operator from scanning bar codes.
SCAN_ENABLE	H	0xE9	Permit bar code scanning.
SLEEP	H	0xEB	Request to place the decoder into low power.
START_DECODE	H	0xE4	Tell the decoder to attempt to decode a bar code.
STOP_DECODE	H	0xE5	Tell the decoder to abort a decode attempt.
WAKEUP	H	N/A	Wake the decoder from low power mode.

For details of the SSI protocol, refer to the *Simple Serial Interface Programmer's Guide*.

SSI Transactions

General Data Transactions

ACK/NAK Handshaking

If you enable ACK/NAK handshaking (the default), all packeted messages must have a CMD_ACK or CMD_NAK response, unless the command description states otherwise. Zebra recommends leaving this handshaking enabled to provide feedback to the host. Raw decode data and WAKEUP do not use ACK/NAK handshaking since they are not packeted data.

Following is an example of a problem which can occur if you disable ACK/NAK handshaking:

- The host sends a PARAM_SEND message to the scanner to change the baud rate from 9600 to 19200.
- The scanner cannot interpret the message.
- The scanner does not implement the change the host requested.
- The host assumes that the parameter change occurred and acts accordingly.
- Communication is lost because the change did not occur on both sides.

If you enable ACK/NAK handshaking, the following occurs:

- The host sends a PARAM_SEND message.
- The scanner cannot interpret the message.
- The scanner CMD_NAKs the message.
- The host resends the message.
- The scanner receives the message successfully, responds with CMD_ACK, and implements parameter changes.

Decoded Data Transmission

The *Decode Data Packet Format* parameter controls how decode data is sent to the host. Set this parameter to send the data in a DECODE_DATA packet. Clear this parameter to transmit the data as raw ASCII data.

✓ **NOTE** When transmitting decode data as raw ASCII data, ACK/NAK handshaking does not apply regardless of the state of the ACK/NAK handshaking parameter.

ACK/NAK Enabled and Packeted Data

The scanner sends a DECODE_DATA message after a successful decode. The scanner waits for a programmable timeout for a CMD_ACK response. If it does not receive the response, the scanner tries to send two more times before issuing a host transmission error. If the scanner receives a CMD_NAK from the host, it may attempt a retry depending on the cause field of the CMD_NAK message.

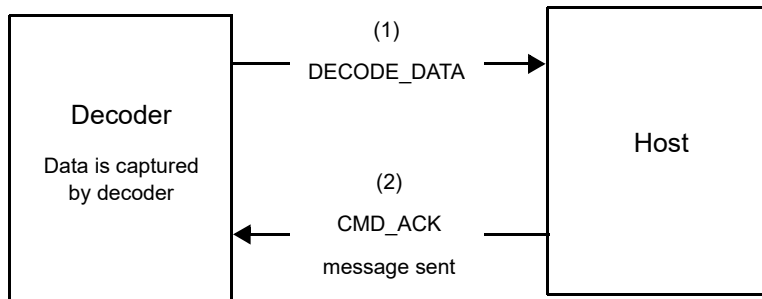

ACK/NAK Enabled and Unpacketed ASCII Data

Even if ACK/NAK handshaking is enabled, no handshaking occurs because handshaking applies only to packeted data. In this example the packeted_decode parameter is disabled.

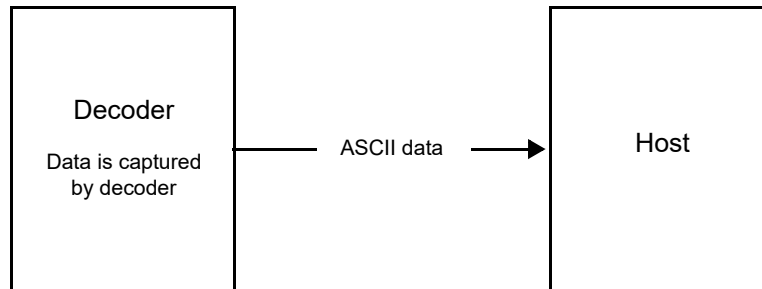

ACK/NAK Disabled and Packeted DECODE_DATA

In this example ACK/NAK does not occur even though packeted_decode is enabled because the ACK/NAK handshaking parameter is disabled.

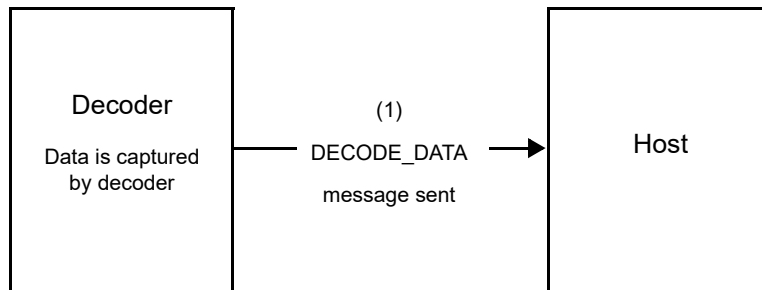

ACK/NAK Disabled and Unpacketed ASCII Data

The decoder sends captured data to the host.

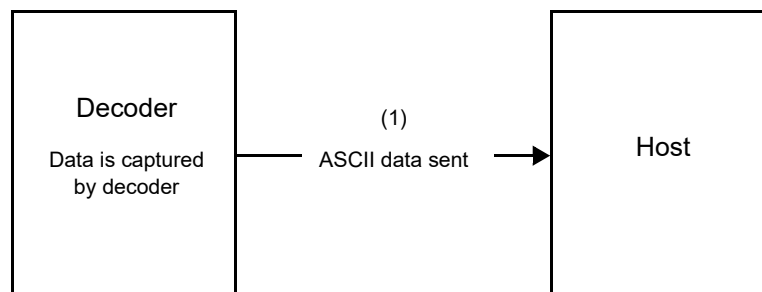

Communication Summary

RTS/CTS Lines

All communication must use RTS/CTS handshaking as described in the *Simple Serial Interface Programmer's Guide*, p/n 72E-40451-xx. If bypassing hardware handshaking, the host must send the WAKEUP command before all other communication or the first byte of a message can be lost during the scanner wakeup sequence. Zebra recommends not bypassing RTS/CTS hardware handshaking.

ACK/NAK Option

ACK/NAK handshaking is enabled by default and Zebra recommends leaving it enabled. Disabling this can cause communication problems, as handshaking is the only acknowledgment that a message was received correctly. ACK/NAK is not used with unpacketed decode data regardless of whether it is enabled.

Number of Data Bits

All communication with the scanner must use 8-bit data.

Serial Response Timeout

The *Host Serial Response Timeout* parameter determines how long to wait for a handshaking response before trying again or aborting further attempts. Set the same value for both the host and scanner.

- ✓ **NOTE** You can temporarily change the *Host Serial Response Timeout* when the host takes longer to process an ACK or longer data string. Zebra does not recommend frequent permanent changes due to limited write cycles of non-volatile memory.

Retries

The host resends data twice after the initial send if the scanner does not respond with an ACK or NAK (if ACK/NAK handshaking is enabled), or response data (e.g., PARAM_SEND, REPLY_REVISION). If the scanner replies with a NAK RESEND, the host resends the data. All resent messages must have the resend bit set in the Status byte.

The scanner resends data two times after the initial send if the host fails to reply with an ACK or NAK (if ACK/NAK handshaking is enabled).

Baud Rate, Stop Bits, Parity, Response Timeout, ACK/NAK Handshaking

If you use PARAM_SEND to change these serial parameters, the ACK response to the PARAM_SEND uses the previous values for these parameters. The new values then take effect for the next transaction.

Errors

The scanner issues a communication error when:

- The CTS line is asserted when the scanner tries to transmit, and is still asserted on each of two successive retries
- The scanner does not receive an ACK or NAK after initial transmit and two resends.

SSI Communication Notes

- When not using hardware handshaking, space messages sufficiently apart. The host must not communicate with the scanner if the scanner is transmitting.
- When using hardware handshaking, frame each message properly with handshaking signals. Do not try to send two commands within the same handshaking frame.
- There is a permanent/temporary bit in the PARAM_SEND message. Removing power from the scanner discards temporary changes. Permanent changes are written to non-volatile memory. Frequent changes shorten the life of the non-volatile memory.

Using Time Delay to Low Power Mode with SSI

Time Delay to Low Power Mode on page 10-19 provides options to select a general time delay. To program a more specific delay value, use an SSI command according to [Table 6-2](#).

Table 6-2 Values for Selecting Time Delay to Low Power

Value	Timeout	Value	Timeout	Value	Timeout	Value	Timeout
0x00	15 Min	0x10	1 Sec	0x20	1 Min	0x30	1 Hour
0x01	30 Min	0x11	1 Sec	0x21	1 Min	0x31	1 Hour
0x02	60 Min	0x12	2 Sec	0x22	2 Min	0x32	2 Hours
0x03	90 Min	0x13	3 Sec	0x23	3 Min	0x33	3 Hours
N/A	N/A	0x14	4 Sec	0x24	4 Min	0x34	4 Hours
N/A	N/A	0x15	5 Sec	0x25	5 Min	0x35	5 Hours
N/A	N/A	0x16	6 Sec	0x26	6 Min	0x36	6 Hours
N/A	N/A	0x17	7 Sec	0x27	7 Min	0x37	7 Hours
N/A	N/A	0x18	8 Sec	0x28	8 Min	0x38	8 Hours
N/A	N/A	0x19	9 Sec	0x29	9 Min	0x39	9 Hours
N/A	N/A	0x1A	10 Sec	0x2A	10 Min	0x3A	10 Hours
N/A	N/A	0x1B	15 Sec	0x2B	15 Min	0x3B	15 Hours
N/A	N/A	0x1C	20 Sec	0x2C	20 Min	0x3C	20 Hours
N/A	N/A	0x1D	30 Sec	0x2D	30 Min	0x3D	30 Hours
N/A	N/A	0x1E	45 Sec	0x2E	45 Min	0x3E	45 Hours
N/A	N/A	0x1F	60 Sec	0x2F	60 Min	0x3F	60 Hours



CAUTION With hardware handshaking disabled, the scanner wakes from low power mode upon receiving a character. However, the scanner does not process this character or any others it receives during the 10 ms period following wakeup. Wait at least 10 ms after wakeup to send valid characters.

Encapsulation of RSM Commands/Responses over SSI

The SSI protocol allows the host to send a command that is variable in length up to 255 bytes. Although there is a provision in the protocol to multi-packet commands from the host, the scanner does not support this. The host must fragment packets using the provisions in the RSM protocol.

Command Structure

Byte	7	6	5	4	3	2	1	0
0	Length (not including the checksum)							
1	SSI_MGMT_COMMAND (0x80)							
2	Message Source (4 - Host)							
3	Reserved (0)			Reserved (0)		Reserved (0)	Cont'd packet	Retransmit
4	Payload data (see the following example)							
...								
Length -1								
Length	2's complement checksum (MSB)							
Length +1	2's complement checksum (LSB)							

The expected positive response is SSI_MGMT_COMMAND which can be a multi-packet response. Devices that do not support this command respond with the standard SSI_NAK.

Response Structure

Byte	7	6	5	4	3	2	1	0
0	Length (not including the checksum)							
1	SSI_MGMT_COMMAND (0x80)							
2	Message Source (0 - Decoder)							
3	Reserved (0)			Reserved (0)		Reserved (0)	Cont'd packet	Retransmit
4	Payload data (see the following example)							
...								
Length -1								
Length	2's complement checksum (MSB)							
Length +1	2's complement checksum (LSB)							

Example Transaction

The following example illustrates how to retrieve diagnostic information (Diagnostic Testing and Reporting (Attribute #10061) decimal) from the scanner using encapsulation of RSM commands over SSI. Before sending an RSM command, the host must send the RSM Get Packet Size command to query the packet size supported by the device.

Command from Host to Query Packet Size Supported by Device

```
0A 80 04 00 00 06 20 00 FF FF FD 4E
```

Where:

- 0A 80 04 00 is encapsulation of RSM commands over SSI command header
- 00 06 20 00 FF FF is RSM Get Packet Size command
- FD 4E is SSI command checksum

Response from Device with Packet Size Information

```
0C 80 00 00 00 08 20 00 00 F0 00 F0 FD 6C
```

Where:

- 0C 80 00 00 is encapsulation of RSM command over SSI command header
- 00 08 20 00 00 F0 00 F0 is RSM Get Packet Size response
- FD 6C is SSI response checksum

Command from Host to Retrieve Diagnostic Information

```
0C 80 04 00 00 08 02 00 27 4D 42 00 FE B0
```

Where:

- 0C 80 04 00 is encapsulation of RSM commands over SSI command header
- 00 08 02 00 27 4D 42 00 is attribute Get command requesting attribute 10061 decimal
- FE B0 is SSI command checksum

Response from Device with Diagnostic Information

```
21 80 00 00 00 1D 02 00 27 4D 41 01 42 00 0E 00 00 00 00 01 03 02 03 03 03 04 03 05 03 06 03 FF FF FC 15
```

Where:

- 21 80 00 00 00 1D 02 00 27 4D 41 01 42 00 0E 00 00 is encapsulation of RSM responses over SSI command header
- 00 00 01 03 02 03 03 03 04 03 05 03 06 03 is attribute Get response which includes diagnostic report value
- FF FF is attribute Get response, packet termination
- FC 15 is SSI response checksum

Setting Parameters

This section describes how to set up the scanner with an SSI host. When using SSI, program the scanner via bar code menu or SSI hosts commands.

The scanner ships with the settings shown in [Table 6-3 on page 6-11](#) (also see [Appendix A, Standard Parameter Defaults](#) for all defaults). If the default values suit requirements, programming is not necessary.

To set feature values, scan a single bar code or a short bar code sequence. The settings are stored in non-volatile memory and are preserved even when the scanner powers down.

✓ **NOTE** Most computer monitors allow scanning bar codes directly on the screen. When scanning from the screen, be sure to set the document magnification to a level where you can see the bar code clearly, and bars and/or spaces do not merge.

To return all features to default values, scan *Set Factory Defaults on page 10-5*. Throughout the programming bar code menus, asterisks (*) indicate default values.

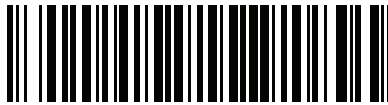

* Indicates default *Enable Parameter (1) Feature/option
Option value

Scanning Sequence Examples

In most cases scanning one bar code sets the parameter value. For example, to set the baud rate to 19,200, scan the **Baud Rate 19,200** bar code under *Baud Rate on page 6-12*. The scanner issues a fast warble beep and the LED turns green, signifying a successful parameter entry.

Other parameters require scanning several bar codes. See the parameter descriptions for this procedure.

Errors While Scanning

Unless otherwise specified, to correct an error during a scanning sequence, just re-scan the correct parameter.

Simple Serial Interface Parameter Defaults

[Table 6-1](#) lists defaults for SSI host parameters. Change these values in one of two ways:

- Scan the appropriate bar codes in this chapter. The new value replaces the standard default value in memory. To recall default parameter values, see *Default Parameters on page 10-5*.
- Download data through the device's serial port using SSI. Hexadecimal parameter numbers appear in this chapter below the parameter title, and option values appear in parenthesis beneath the accompanying bar codes. Refer to the *Simple Serial Interface (SSI) Programmer's Guide* for detailed instructions for changing parameters using this method.

✓ **NOTE** See [Appendix A, Standard Parameter Defaults](#) for all user preference, host, symbology, and miscellaneous default parameters.

Table 6-3 SSI Interface Default Table

Parameter	Parameter Number	SSI Number	Default	Page Number
SSI Host Parameters				
Select SSI Host	N/A	N/A	N/A	6-12
Baud Rate	156	9Ch	9600	6-12
Parity	158	9Eh	None	6-13
Check Parity	151	97h	Disable	6-14
Stop Bits	157	9Dh	1	6-15
Software Handshaking	159	9Fh	ACK/NAK	6-16
Host RTS Line State	154	9Ah	Low	6-17
Decode Data Packet Format	238	EEh	Send Raw Decode Data	6-17
Host Serial Response Timeout	155	9Bh	2 Seconds	6-18
Host Character Timeout	239	EFh	200 msec	6-19
Multipacket Option	334	F0h 4Eh	Option 1	6-20
Interpacket Delay	335	F0h 4Fh	0 msec	6-21
Event Reporting				
Decode Event	256	F0h 00h	Disable	6-22
Boot Up Event	258	F0h 02h	Disable	6-23
Parameter Event	259	F0h 03h	Disable	6-23

✓ **NOTE** SSI interprets Prefix, Suffix1, and Suffix2 values listed in [Table D-1 on page D-1](#) differently than other interfaces. SSI does not recognize key categories, only the 3-digit decimal value. The default value of 7013 is interpreted as CR only.

SSI Host Parameters

Select SSI Host

To select SSI as the host interface, scan the following bar code.



SSI Host

Baud Rate

Parameter # 156

SSI # 9Ch

Baud rate is the number of bits of data transmitted per second. Scan one of the following bar codes to set the scanner's baud rate to match the baud rate setting of the host device. Otherwise, data may not reach the host device or may reach it in distorted form.



***Baud Rate 9600
(6)**



**Baud Rate 19,200
(7)**



**Baud Rate 38,400
(8)**



**Baud Rate 57,600
(10)**

Baud Rate (continued)



Baud Rate 115,200
(11)



Baud Rate 230,400
(13)



Baud Rate 460,800
(14)



Baud Rate 921,600
(15)

Parity

Parameter # 158

SSI # 9Eh

A parity check bit is the most significant bit of each ASCII coded character. Scan one of the following bar codes to select the parity type according to host device requirements:

- **Odd** - This sets the parity bit value to 0 or 1, based on data, to ensure that the coded character contains an odd number of 1 bits.
- **Even** - This sets the parity bit value to 0 or 1, based on data, to ensure that the coded character contains an even number of 1 bits.

- **None** - No parity bit is required.



**Odd
(2)**



**Even
(1)**



***None
(0)**

Check Parity

Parameter # 151

SSI # 97h

Scan one of the following bar codes to select whether to check the parity of received characters. See [Parity](#) to select the type of parity.



***Do Not Check Parity
(0)**



**Check Parity
(1)**

Stop Bits

Parameter # 157

SSI # 9Dh

The stop bit(s) at the end of each transmitted character marks the end of transmission of one character and prepares the receiving device for the next character in the serial data stream. Scan one of the following bar codes to set the number of stop bits (one or two) based on the number the receiving host can accommodate.



***1 Stop Bit
(1)**



**2 Stop Bits
(2)**

Software Handshaking

Parameter # 159

SSI # 9Fh

This parameter offers control of data transmission in addition to the control hardware handshaking offers. Hardware handshaking is always enabled; you cannot disable it.

Options:

- **Disable ACK/NAK Handshaking** - The scanner neither generates nor expects ACK/NAK handshaking packets.
- **Enable ACK/NAK Handshaking** - After transmitting data, the scanner expects either an ACK or NAK response from the host. The scanner also ACKs or NAKs messages from the host.

The scanner waits up to the programmable *Host Serial Response Timeout* to receive an ACK or NAK. If the scanner does not get a response in this time, it resends its data up to two times before discarding the data and declaring a transmission error.



**Disable ACK/NAK
(0)**



***Enable ACK/NAK
(1)**

Host RTS Line State

Parameter # 154

SSI # 9Ah

Scan one of the following bar codes to set the expected idle state of the Serial Host RTS line.

The SSI interface is used with host applications which also implement the SSI protocol. However, you can use the scanner in a "scan-and-transmit" mode to communicate with any standard serial communication software on a host PC (see *Decode Data Packet Format on page 6-17*). If transmission errors occur in this mode, the host PC may be asserting hardware handshaking lines which interfere with the SSI protocol. Scan the **High** bar code to address this problem.



*Low
(0)



High
(1)

Decode Data Packet Format

Parameter # 238

SSI # Eeh

Scan one of the following bar codes to select whether to transmit decoded data in raw format (unpacketed), or with the packet format defined by the serial protocol.

Selecting the raw format disables ACK/NAK handshaking for decode data.



*Send Raw Decode Data
(0)



Send Packeted Decode Data
(1)

Host Serial Response Timeout

Parameter # 155

SSI # 9Bh

Scan one of the following bar codes to specify how long the scanner waits for an ACK or NAK before resending. Also, if the scanner wants to send, and the host has already been granted permission to send, the scanner waits for the designated timeout before declaring an error.

✓ **NOTE** Other values are available via SSI command.



***Low - 2 Seconds**
(20)



Medium - 5 Seconds
(50)



High - 7.5 Seconds
(75)



Maximum - 9.9 Seconds
(99)

Host Character Timeout

Parameter # 239

SSI # EFh

Scan one of the following bar codes to specify the maximum time the scanner waits between characters transmitted by the host before discarding the received data and declaring an error.

✓ **NOTE** Other values are available via SSI command.



***Low - 200 msec
(20)**



**Medium - 500 msec
(50)**



**High - 750 msec
(75)**



**Maximum - 990 msec
(99)**

Multipacket Option

Parameter # 334

SSI # F0h 4Eh

Scan one of the following bar codes to control ACK/NAK handshaking for multi-packet transmissions:

- **Multi-Packet Option 1** - The host sends an ACK/NAK for each data packet during a multi-packet transmission.
- **Multi-Packet Option 2** - The scanner sends data packets continuously, with no ACK/NAK handshaking to pace the transmission. The host, if overrun, can use hardware handshaking to temporarily delay scanner transmissions. At the end of transmission, the scanner waits for a CMD_ACK or CMD_NAK.
- **Multi-Packet Option 3** - This is the same as option 2 with the addition of a programmable interpacket delay. See *Interpacket Delay* on page 6-21 to set this delay.



***Multipacket Option 1**
(0)



Multipacket Option 2
(1)



Multipacket Option 3
(2)

Interpacket Delay

Parameter # 335

SSI # F0h 4Fh

Scan one of the following bar codes to specify the interpacket delay if you selected **Multipacket Option 3**.

✓ **NOTE** Other values are available via SSI command.



*Minimum - 0 msec
(0)



Low - 25 msec
(25)



Medium - 50 msec
(50)



High - 75 msec
(75)



Maximum - 99 msec
(99)

Event Reporting

The host can request the scanner to provide certain information (events) relative to scanner behavior. Scan the following bar codes to enable or disable the events listed in [Table 6-4](#) and on the following pages.

Table 6-4 *Event Codes*

Event Class	Event	Code Reported
Decode Event	Non-parameter decode	0x01
Boot Up Event	System power-up	0x03
Parameter Event	Parameter entry error	0x07
	Parameter stored	0x08
	Defaults set (and parameter event is enabled by default)	0x0A
	Number expected	0x0F

Decode Event

Parameter # 256

SSI # F0h 00h

Scan one of the following bar codes to enable or disable Decode Event.

- **Enable Decode Event** - The scanner generates a message to the host upon a successful bar code decode.
- **Disable Decode Event** - No notification is sent.

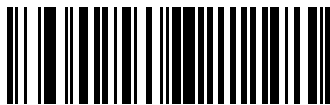

Enable Decode Event
(1)



***Disable Decode Event**
(0)

Boot Up Event

Parameter # 258

SSI # F0h 02h

Scan one of the following bar codes to enable or disable Boot Up Event:

- **Enable Boot Up Event** - The scanner generates a message to the host whenever power is applied.
- **Disable Boot Up Event** - No notification is sent.

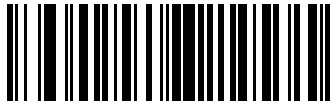

Enable Boot Up Event
(1)

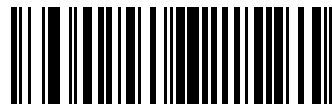

*Disable Boot Up Event
(0)

Parameter Event

Parameter # 259

SSI # F0h 03h

Scan one of the following bar codes to enable or disable Parameter Event:

- **Enable Parameter Event** - The scanner generates a message to the host when one of the events specified in [Table 6-4 on page 6-22](#) occurs.
- **Disable Parameter Event** - No notification is sent.

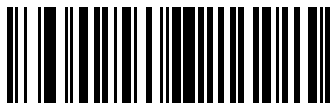

Enable Parameter Event
(1)

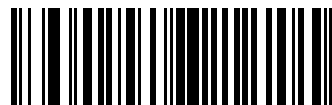

*Disable Parameter Event
(0)

CHAPTER 7 RS-232 INTERFACE

Introduction

This chapter describes how to set up the scanner with an RS-232 host. The scanner uses the RS-232 interface to connect to point-of-sale devices, host computers, or other devices with an available RS-232 port (e.g., com port).

The scanner ships with the settings shown in [Table 7-1 on page 7-3](#) (also see [Appendix A, Standard Parameter Defaults](#) for all defaults). If the default values suit requirements, programming is not necessary.

If your host does not appear in [Table 7-2](#), refer to the documentation for the host device to set communication parameters to match the host.

- ✓ **NOTE** The scanner uses TTL RS-232 signal levels, which interface with most system architectures. For system architectures requiring RS-232C signal levels, Zebra offers different cables providing TTL-to-RS-232C conversion. Contact support for more information.

Setting Parameters

To set feature values, scan a single bar code or a short bar code sequence. The settings are stored in non-volatile memory and are preserved even when the scanner powers down.

- ✓ **NOTE** Most computer monitors allow scanning bar codes directly on the screen. When scanning from the screen, be sure to set the document magnification to a level where you can see the bar code clearly, and bars and/or spaces do not merge.

To return all features to default values, scan *Set Factory Defaults on page 10-5*. Throughout the programming bar code menus, asterisks (*) indicate default values.



* Indicates default *Enable Parameter Feature/option

Scanning Sequence Examples

In most cases scanning one bar code sets the parameter value. For example, to set the baud rate to 19,200, scan the **Baud Rate 19,200** bar code under *Baud Rate* on page 7-9. The scanner issues a fast warble beep and the LED turns green, signifying a successful parameter entry.

Other parameters require scanning several bar codes. See the parameter descriptions for this procedure.

Errors While Scanning

Unless otherwise specified, to correct an error during a scanning sequence, just re-scan the correct parameter.

Connecting an RS-232 Interface

Connect the scanner directly to the host computer.

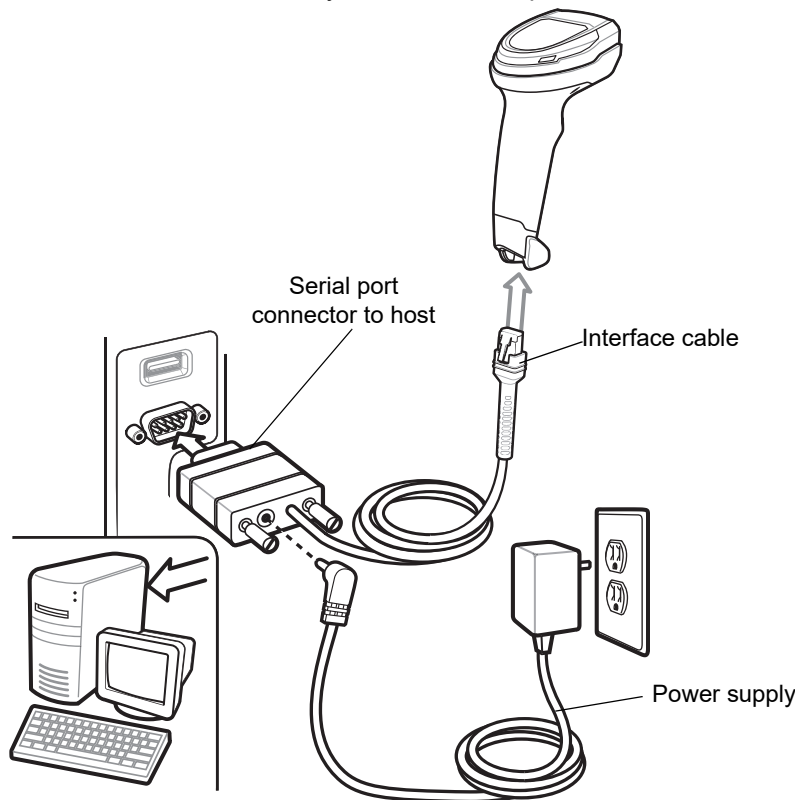

Figure 7-1 RS-232 Connection

✓ **NOTE** Interface cables vary depending on configuration. The connectors can be different than those illustrated in [Figure 7-1](#), but the steps to connect the scanner are the same.

1. Attach the modular connector of the RS-232 interface cable to the cable interface port on the scanner. See [Installing the Interface Cable on page 1-3](#).
2. Connect the other end of the RS-232 interface cable to the serial port on the host.
3. If required, connect the power supply to the serial connector end of the RS-232 interface cable. Plug the power supply into an appropriate outlet.

4. The scanner automatically detects the host interface type and uses the default setting. If the default (*) does not meet your requirements, select another RS-232 host type by scanning the appropriate bar code from *RS-232 Host Types on page 7-7*.
5. To modify any other parameter options, scan the appropriate bar codes in this chapter.

If problems occur with the system, see *Troubleshooting on page 4-5*.

RS-232 Parameter Defaults

Table 7-1 lists defaults for RS-232 host parameters. Change these values in one of two ways:

- Scan the appropriate bar codes in this chapter. The new value replaces the standard default value in memory. To recall default parameter values, see *Default Parameters on page 10-5*.
- Configure the scanner using the 123Scan configuration program. See [Chapter 2, 123Scan and Software Tools](#).

✓ **NOTE** See [Appendix A, Standard Parameter Defaults](#) for all user preference, host, symbology, and miscellaneous default parameters.

Table 7-1 *RS-232 Interface Parameter Defaults*

Parameter	Default	Page Number
RS-232 Host Parameters		
RS-232 Host Types	Standard	7-7
Baud Rate	9600	7-9
Parity	None	7-10
Stop Bits	1 Stop Bit	7-11
Data Bits	8-bit	7-11
Check Receive Errors	Enable	7-12
Hardware Handshaking	None	7-12
Software Handshaking	None	7-14
Host Serial Response Timeout	2 Sec	7-16
RTS Line State	Low RTS	7-17
Beep on <BEL>	Disable	7-17
Intercharacter Delay	0 msec	7-18
Nixdorf Beep/LED Options	Normal Operation	7-19
Bar Codes with Unknown Characters	Send Bar Code With Unknown Characters	7-19

Table 7-1 RS-232 Interface Parameter Defaults (Continued)

Parameter	Default	Page Number
Datalogic Host Format	Enable	7-20
Datalogic Supported Commands	None	7-20

RS-232 Host Parameters

Various RS-232 hosts use their own parameter default settings. Selecting standard, ICL, Fujitsu, Wincor-Nixdorf Mode A, Wincor-Nixdorf Mode B, OPOS/JPOS, Olivetti, Omron, or Common Use Terminal Equipment (CUTE-LP/LG bar code readers) sets the defaults listed in [Table 7-2](#).

Table 7-2 Terminal Specific RS-232

Parameter	ICL	Fujitsu	Wincor-Nixdorf Mode A	Wincor-Nixdorf Mode B/OPOS/JPOS	Olivetti	Omron	CUTE	Datalogic
Transmit Code ID	Yes	Yes	Yes	Yes	Yes	Yes	Yes	Yes
Data Transmission Format	Data/Suffix	Data/Suffix	Data/Suffix	Data/Suffix	Prefix/Data/Suffix	Data/Suffix	Prefix/Data/Suffix	Data/Suffix
Suffix	CR (1013)	CR (1013)	CR (1013)	CR (1013)	ETX (1002)	CR (1013)	CR (1013) ETX (1003)	CR (1013)
Baud Rate	9600	9600	9600	9600	9600	9600	9600	9600
Parity	Even	None	Odd	Odd	Even	None	Even	Odd
Hardware Handshaking	RTS/CTS Option 3	None	RTS/CTS Option 3	RTS/CTS Option 3	None	None	None	None
Software Handshaking	None	None	None	None	ACK/NAK	None	None	None
Serial Response Timeout	9.9 Sec.	2 Sec.	None	None	9.9 Sec.	9.9 Sec.	9.9 Sec.	9.9 sec.
Stop Bit Select	One	One	One	One	One	One	One	One
ASCII Format	8-Bit	8-Bit	8-Bit	8-Bit	7-Bit	8-Bit	7-Bit	7-Bit

In the Wincor-Nixdorf Mode A/B, if CTS is low, scanning is disabled. When CTS is high, scanning is enabled. If you scan Wincor-Nixdorf RS-232 Mode A/B without connecting the scanner to the proper host, it may appear unable to scan. If this happens, scan a different RS-232 host type within 5 seconds of cycling power to the scanner.

The CUTE host disables all parameter scanning, including Set Defaults. If you inadvertently select CUTE, scan *Enable Parameter Bar Code Scanning (1) on page 10-6, then change the host selection.

Table 7-2 Terminal Specific RS-232 (Continued)

Parameter	ICL	Fujitsu	Wincor-Nixdorf Mode A	Wincor-Nixdorf Mode B/OPOS/JP OS	Olivetti	Omron	CUTE	Datalogic
Beep On <BEL>	Disable	Disable	Disable	Disable	Disable	Disable	Disable	Enable
RTS Line State	High	Low	Low	Low = No data to send	Low	High	High	High
Prefix	None	None	None	None	STX (1003)	None	STX (1002)	None

In the Wincor-Nixdorf Mode A/B, if CTS is low, scanning is disabled. When CTS is high, scanning is enabled. If you scan Wincor-Nixdorf RS-232 Mode A/B without connecting the scanner to the proper host, it may appear unable to scan. If this happens, scan a different RS-232 host type within 5 seconds of cycling power to the scanner.

The CUTE host disables all parameter scanning, including Set Defaults. If you inadvertently select CUTE, scan **Enable Parameter Bar Code Scanning (1)* on page 10-6, then change the host selection.

RS-232 Host Parameters (continued)

Selecting ICL, Fujitsu, Wincor-Nixdorf Mode A, Wincor-Nixdorf Mode B, OPOS/JPOS, Olivetti, Omron, or CUTE-LP/LG bar code readers transmits the code ID characters listed in [Table 7-3](#). These code ID characters are not programmable and are separate from the Transmit Code ID feature. Do not enable the Transmit Code ID feature for these terminals.

Table 7-3 Terminal Specific Code ID Characters

Code Type	ICL	Fujitsu	Wincor-Nixdorf Mode A	Wincor-Nixdorf Mode B/OPOS/JPOS	Olivetti	Omron	CUTE	Datalogic
UPC-A	A	A	A	A	A	A	A	A
UPC-E	E	E	C	C	C	E	None	E
EAN-8/JAN-8	FF	FF	B	B	B	FF	None	FF
EAN-13/JAN-13	F	F	A	A	A	F	A	F
Code 39	C <len>	None	M	M	M <len>	C <len>	3	*
Code 39 Full ASCII	None	None	M	M	None	None	3	None
Codabar	N <len>	None	N	N	N <len>	N <len>	None	%
Code 128	L <len>	None	K	K	K <len>	L <len>	5	#
I 2 of 5	I <len>	None	I	I	I <len>	I <len>	1	i
Code 93	None	None	L	L	L <len>	None	None	&
D 2 of 5	H <len>	None	H	H	H <len>	H <len>	2	None
GS1-128	L <len>	None	P	P	P <len>	L <len>	5	None
MSI	None	None	O	O	O <len>	None	None	@
Bookland EAN	F	F	A	A	A	F	None	None
Trioptic	None	None	None	None	None	None	None	\$T
Code 11	None	None	None	None	None	None	None	CE
IATA	H<len>	None	H	H	H<len>	H<len>	2	IA
Code 32	None	None	None	None	None	None	None	AE
GS1 DataBar Variants	None	None	E	E	None	None	None	GS1 DataBar - R4; GS1 DataBar Limited - RL; GS1 DataBar Expanded - RX
PDF417	None	None	Q	Q	None	None	6	P
Data Matrix	None	None	R	R	None	None	4	Dm
GS1 Data Matrix	None	None	W	W	None	None	None	None

Table 7-3 Terminal Specific Code ID Characters (Continued)

Code Type	ICL	Fujitsu	Wincor-Nixdorf Mode A	Wincor-Nixdorf Mode B/OPOS/JPOS	Olivetti	Omron	CUTE	Datalogic
QR Codes	None	None	U	U	None	None	7	QR
GS1 QR	None	None	X	X	None	None	None	None
Aztec/Aztec Rune	None	None	V	V	None	None	8	Az
Maxicode	None	None	T	T	None	None	None	MC
MicroPDF	None	None	S	S	None	None	6	mP
Australia Post	None	None	None	None	None	None	None	\$K
Japan Postal	None	None	None	None	None	None	None	\$R
US Planet	None	None	None	None	None	None	None	\$W
US Postnet	None	None	None	None	None	None	None	1

RS-232 Host Types

To select an RS-232 host interface, scan one of the following bar codes.

- ✓ **NOTE** For a list of supported scanner functionality by communication protocol, see [Appendix F, Communication Protocol Functionality](#).



*Standard RS-232¹

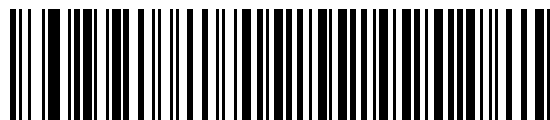

ICL RS-232

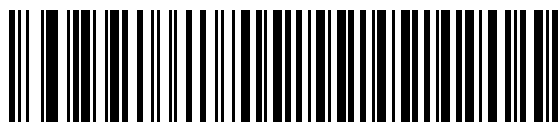

Wincor-Nixdorf RS-232 Mode A

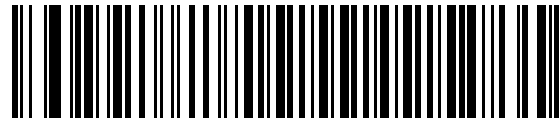

Wincor-Nixdorf RS-232 Mode B

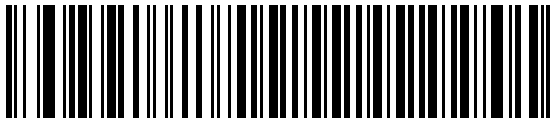

Olivetti ORS4500



Omron



OPOS/JPOS

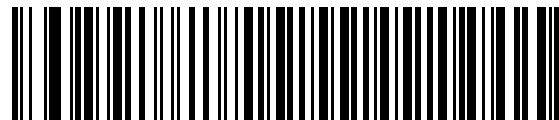

Fujitsu RS-232

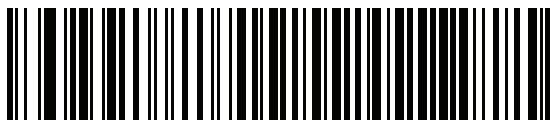

CUTE²



Datalogic Variant

¹Scanning Standard RS-232 activates the RS-232 driver, but does not change port settings (e.g., parity, data bits, handshaking). Selecting another RS-232 host type bar code changes these settings.

²The CUTE host disables all parameter scanning, including Set Defaults. If you inadvertently select CUTE, scan **Enable Parameter Bar Code Scanning (1)* on page 10-6, and then change the host selection.

Baud Rate

Baud rate is the number of bits of data transmitted per second. Scan one of the following bar codes to set the scanner's baud rate to match the baud rate setting of the host device. Otherwise, data may not reach the host device or may reach it in distorted form.

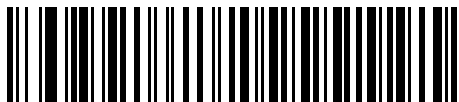

Baud Rate 4800



***Baud Rate 9600**



Baud Rate 19,200



Baud Rate 38,400



Baud Rate 57,600



Baud Rate 115,200

Parity

A parity check bit is the most significant bit of each ASCII coded character. Scan one of the following bar codes to select the parity type according to host device requirements:

- **Odd** - This sets the parity bit value to 0 or 1, based on data, to ensure that the coded character contains an odd number of 1 bits.
- **Even** - This sets the parity bit value to 0 or 1, based on data, to ensure that the coded character contains an even number of 1 bits.
- **None** - No parity bit is required.



Odd

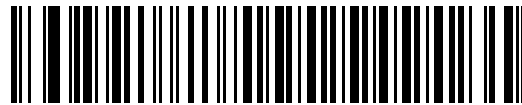

Even



***None**

Stop Bits

The stop bit(s) at the end of each transmitted character marks the end of transmission of one character and prepares the receiving device for the next character in the serial data stream. Scan one of the following bar codes to set the number of stop bits (one or two) based on the number the receiving host can accommodate.



***1 Stop Bit**

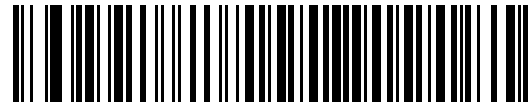

2 Stop Bits

Data Bits

This parameter allows the scanner to interface with devices requiring a 7-bit or 8-bit ASCII protocol.

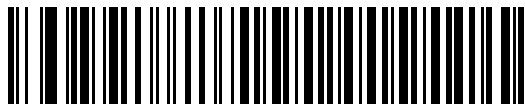

7-bit

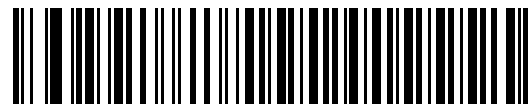

***8-bit**

Check Receive Errors

Scan one of the following bar codes to set whether to check the parity, framing, and overrun of received characters. The parity value of received characters is verified against the value set for *Parity on page 7-10*.

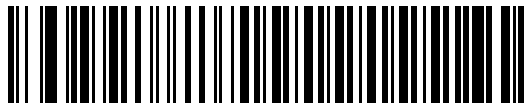

***Check For Received Errors**

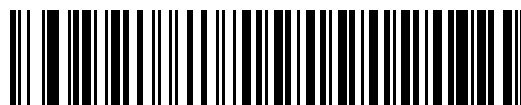

Do Not Check For Received Errors

Hardware Handshaking

The data interface consists of an RS-232 port designed to operate either with or without the hardware handshaking lines Request to Send (RTS) and Clear to Send (CTS).

If hardware handshaking and software handshaking are both enabled, hardware handshaking takes precedence.

✓ **NOTE** The DTR signal is jumpered to the active state.

Options:

- **None** - This disables hardware handshaking and transmits scan data as it becomes available.
- **Standard RTS/CTS** - This sets standard RTS/CTS hardware handshaking and transmits scanned data according to the following sequence:
 - a. The scanner reads the CTS line for activity:
 - If the CTS line is de-asserted, the scanner asserts the RTS line and waits up to *Host Serial Response Timeout on page 7-16* for the host to assert CTS, and then transmits data when asserted. If, after the timeout, the CTS line is not asserted, the scanner sounds a transmit error and discards the data.
 - If CTS is asserted, the scanner waits up to *Host Serial Response Timeout* for the host to de-assert CTS. If after this timeout the CTS line is still asserted, the scanner sounds a transmit error and discards the scanned data.
 - b. The scanner de-asserts RTS after sending the last character of data.
 - c. The host negates CTS. The scanner checks for a de-asserted CTS upon the next data transmission.

During data transmission, if CTS is deasserted for more than 50 ms between characters, the scanner sounds a transmit error and discards the data. The data must be re-scanned.
- **RTS/CTS Option 1** - The scanner asserts RTS before transmitting and ignores the state of CTS. The scanner de-asserts RTS when transmission completes.

Hardware Handshaking (continued)

- **RTS/CTS Option 2** - RTS is always high or low (user-programmed logic level). However, the scanner waits for the host to assert CTS before transmitting data. If CTS is not asserted within the *Host Serial Response Timeout*, the scanner sounds a transmit error and discards the data. During data transmission, if CTS is deasserted for more than 50 ms between characters, the scanner sounds a transmit error and discards the data.
- **RTS/CTS Option 3** - This transmits scanned data according to the following sequence:
 - a. The scanner asserts RTS before data transmission, regardless of the state of CTS.
 - b. The scanner waits up to the *Host Serial Response Timeout* for the host to assert CTS, and then transmits data when asserted. If, after the timeout, the CTS line is not asserted, the scanner sounds a transmit error and discards the data.
 - c. The scanner de-asserts RTS after sending the last character of data.
 - d. The host negates CTS. The scanner checks for a de-asserted CTS upon the next data transmission. During data transmission, if CTS is deasserted for more than 50 ms between characters, the scanner sounds a transmit error and discards the data. The data must be re-scanned.



*None

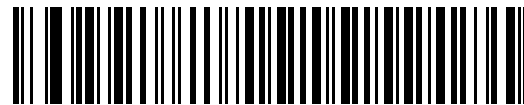

Standard RTS/CTS

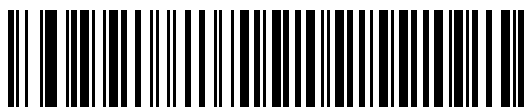

RTS/CTS Option 1



RTS/CTS Option 2

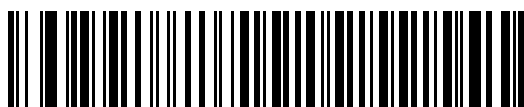

RTS/CTS Option 3

Software Handshaking

This parameter offers control of data transmission in addition to, or instead of, that offered by hardware handshaking. If software handshaking and hardware handshaking are both enabled, hardware handshaking takes precedence.

Options:

- **None** - This transmits data immediately. The scanner expects no response from the host.
- **ACK/NAK** - After transmitting data, the scanner waits for an ACK or NAK response from the host. If it receives a NAK, the scanner transmits the data again and waits for an ACK or NAK. After three unsuccessful attempts to send data after receiving NAKs, the scanner sounds a transmit error and discards the data.

The scanner waits up to the programmable *Host Serial Response Timeout* to receive an ACK or NAK. If the scanner does not get a response in this time, it sounds a transmit error and discards the data. There are no reattempts.

- **ENQ** - The scanner waits for an ENQ character from the host before transmitting data. If it does not receive an ENQ within the *Host Serial Response Timeout*, the scanner sounds a transmit error and discards the data. The host must transmit an ENQ character at least every *Host Serial Response Timeout* to prevent transmission errors.
- **ACK/NAK with ENQ** - This combines the two previous options. An additional ENQ is not required to re-transmit data due to a NAK from the host.
- **XON/XOFF** - An XOFF character stops data transmission until the scanner receives an XON character. There are two situations for XON/XOFF:
 - The scanner receives an XOFF before it has data to send. When the scanner has data, it waits up to the *Host Serial Response Timeout* for an XON character before transmitting. If it does not receive the XON within this time, the scanner sounds a transmit error and discards the data.
 - The scanner receives an XOFF during data transmission and stops transmission after sending the current byte. When the scanner receives an XON character, it sends the rest of the data. The scanner waits indefinitely for the XON.

Software Handshaking (continued)



***None**



ACK/NAK

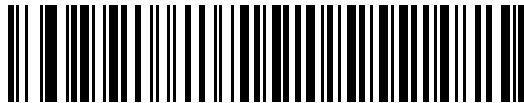

ENQ



ACK/NAK with ENQ

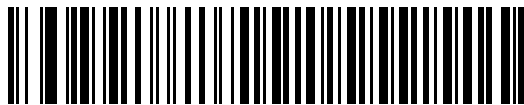

XON/XOFF

Host Serial Response Timeout

Scan one of the following bar codes to specify how long the scanner waits for an ACK, NAK, or CTS before determining that a transmission error occurred. This only applies when in one of the ACK/NAK software handshaking modes, or RTS/CTS hardware handshaking mode.



***Minimum: 2 Seconds**



Low: 2.5 Seconds



Medium: 5 Seconds

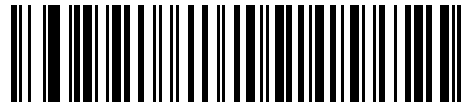

High: 7.5 Seconds

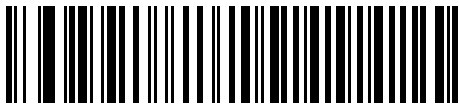

Maximum: 9.9 Seconds

RTS Line State

Scan one of the following bar codes to set the idle state of the serial host RTS line to **Low RTS** or **High RTS**.

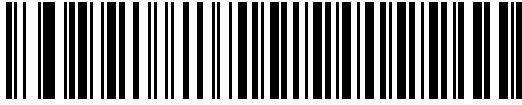

***Host: Low RTS**



Host: High RTS

Beep on <BEL>

Scan one of the following bar codes to set whether the scanner issues a beep when it detects a <BEL> character on the RS-232 serial line. <BEL> indicates an illegal entry or other important event.

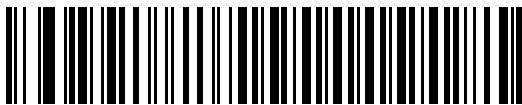

**Beep On <BEL> Character
(Enable)**



***Do Not Beep On <BEL> Character
(Disable)**

Intercharacter Delay

Scan one of the following bar codes to specify the intercharacter delay inserted between character transmissions.



***Minimum: 0 msec**

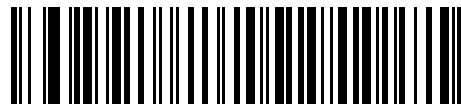

Low: 25 msec

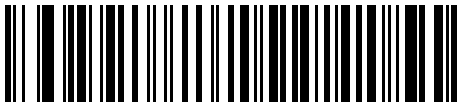

Medium: 50 msec



High: 75 msec

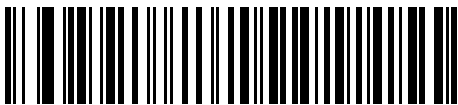

Maximum: 99 msec

Nixdorf Beep/LED Options

If you selected Nixdorf Mode B, scan one of the following bar codes to indicate when the scanner beeps and turns on its LED after a decode.

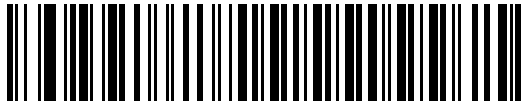

***Normal Operation**
(Beep/LED Immediately After Decode)

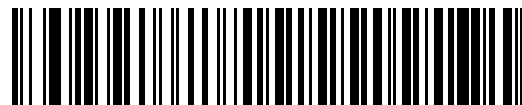

Beep/LED After Transmission



Beep/LED After CTS Pulse

Bar Codes with Unknown Characters

Unknown characters are characters the host does not recognize. Scan **Send Bar Codes With Unknown Characters** to send all bar code data except for unknown characters. The scanner issues no error beeps.

Scan **Do Not Send Bar Codes With Unknown Characters** to send bar code data up to the first unknown character. The scanner issues an error beep.

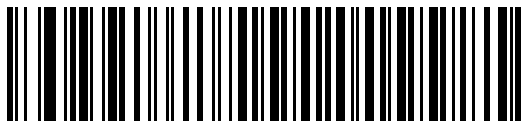

***Send Bar Codes With Unknown Characters**



Do Not Send Bar Codes With Unknown Characters

Datalogic Host Format

The following commands are supported over RS232 or USB CDC.

Parameter # 2253 (SSI # F8 08 CD)

When this parameter is enabled (default), the Datalogic host variant appends a code ID and a suffix value (CR) to the decoded data. When this parameter is disabled, only the decode data is transmitted.

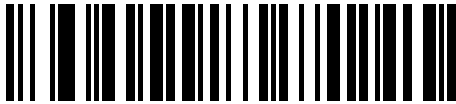

*Enable
(1)

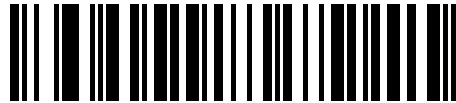

Disable
(0)

Datalogic Supported Commands

Parameter # 2260 (SSI # F8 08 D4)

This parameter allows serial scan to enable or disable commands for a standard RS232 host.

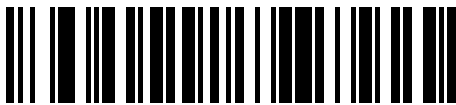

Enable
(1)



*Disable
(0)

- 'E' or 'e' = Enable Scanning
- 'D' or 'd' = Disable Scanning
- 'R' = Reset the scanner
- 'F' = Indicate to the scanner that Datalogic is not on file
- 'B' = Issue a good read beep
- 1 (Not an ASCII Character – This is a decimal number 1) = Force a good read beep
- 7 (Not an ASCII Character – This is a decimal number 7) = Force a good read beep

ASCII Character Sets

See [Table D-1, ASCII Character Set on page D-1](#) for prefix/suffix values.

CHAPTER 8 IBM 468X / 469X INTERFACE

Introduction

This chapter describes how to set up the scanner with an IBM 468X/469X host.

The scanner ships with the settings shown in [Table 8-1 on page 8-3](#) (also see [Appendix A, Standard Parameter Defaults](#) for all defaults). If the default values suit requirements, programming is not necessary.

Setting Parameters

To set feature values, scan a single bar code or a short bar code sequence. The settings are stored in non-volatile memory and are preserved even when the scanner powers down.

✓ **NOTE** Most computer monitors allow scanning bar codes directly on the screen. When scanning from the screen, be sure to set the document magnification to a level where you can see the bar code clearly, and bars and/or spaces do not merge.

To return all features to default values, scan *Set Factory Defaults on page 10-5*. Throughout the programming bar code menus, asterisks (*) indicate default values.



* Indicates default *Enable Parameter Feature/option

Scanning Sequence Examples

In most cases scanning one bar code sets the parameter value. For example, to select the Port 9B address, scan the **Hand-held Scanner Emulation (Port 9B)** bar code under *Port Address on page 8-4*. The scanner issues a fast warble beep and the LED turns green, signifying a successful parameter entry.

Other parameters require scanning several bar codes. See the parameter descriptions for this procedure.

Errors While Scanning

Unless otherwise specified, to correct an error during a scanning sequence, just re-scan the correct parameter.

Connecting an IBM 468X/469X Host

Connect the scanner directly to the host computer.

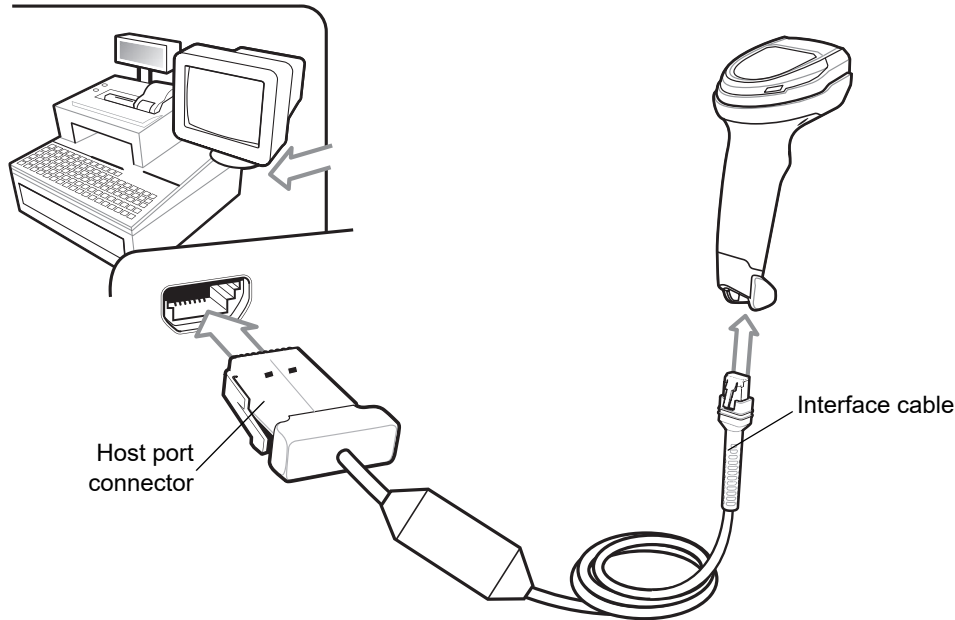

Figure 8-1 IBM Connection

✓ **NOTE** Interface cables vary depending on configuration. The connectors can be different than those illustrated in [Figure 8-1](#), but the steps to connect the scanner are the same.

1. Attach the modular connector of the IBM 46XX interface cable to the cable interface port on the scanner. See [Installing the Interface Cable on page 1-3](#).
2. Connect the other end of the IBM 46XX interface cable to the appropriate port on the host (typically Port 9).
3. The scanner automatically detects the host interface type, but there is no default setting. Scan the appropriate bar code from [Port Address on page 8-4](#) to select the port address.
4. To modify any other parameter options, scan the appropriate bar codes in this chapter.

✓ **NOTE** The only required configuration is the port address. The IBM system typically controls other scanner parameters.

If problems occur with the system, see [Troubleshooting on page 4-5](#).

IBM Parameter Defaults

[Table 8-1](#) lists defaults for IBM host parameters. Change these values in one of two ways:

- Scan the appropriate bar codes in this chapter. The new value replaces the standard default value in memory. To recall default parameter values, see *Default Parameters on page 10-5*.
- Configure the scanner using the 123Scan configuration program. See [Chapter 2, 123Scan and Software Tools](#).

✓ **NOTE** See [Appendix A, Standard Parameter Defaults](#) for all user preference, host, symbology, and miscellaneous default parameters.

Table 8-1 IBM 468X/469X Interface Parameter Defaults

Parameter	Default	Page Number
IBM 468X/469X Host Parameters		
Port Address	None	8-4
Convert Unknown to Code 39	Disable	8-5
RS-485 Beep Directive	Honor	8-5
RS-485 Bar Code Configuration Directive	Ignore	8-6
IBM-485 Specification Version	Original Specification	8-6

IBM Host Parameters

Port Address

Scan one of the following bar codes to select the IBM 468X/469X port.

- ✓ **NOTE** Scanning a Port Address bar code enables the RS-485 interface on the scanner.

- ✓ **NOTE** For a list of supported scanner functionality by communication protocol, see [Appendix F, Communication Protocol Functionality](#).

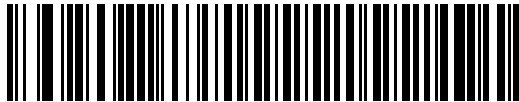

***None**



Hand-held Scanner Emulation (Port 9B)

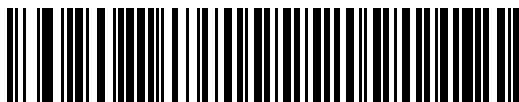

Non-IBM Scanner Emulation (Port 5B)



Table-top Scanner Emulation (Port 17)

Convert Unknown to Code 39

Scan one of the following bar codes to enable or disable converting unknown bar code type data to Code 39.



Enable Convert Unknown to Code 39

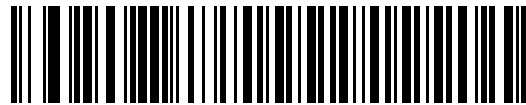

***Disable Convert Unknown to Code 39**

RS-485 Beep Directive

The IBM RS-485 host can send a beeper configuration request to the scanner. Scan **Ignore Beep Directive** to prevent the scanner from processing the host request. All directives are still acknowledged to the host as if they were processed.



***Honor Beep Directive**



Ignore Beep Directive

RS-485 Bar Code Configuration Directive

The IBM RS-485 host can enable and disable code types. Scan **Ignore Bar Code Configuration Directive** to prevent the scanner from processing the host request. All directives are still acknowledged to the IBM RS-485 host as if they were processed.



Honor Bar Code Configuration Directive



***Ignore Bar Code Configuration Directive**

IBM-485 Specification Version

Parameter # 1729 (SSI # F8h 06h C1h)

The IBM interface specification version selected defines how code types are reported over the IBM interface.

When you scan **Original Specification**, only Symbologies that were historically supported on each individual port are reported as known. When you scan Version 2.0, all Symbologies covered in the newer IBM specification are reported as known with their respective code types.

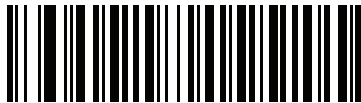

***Original Specification
(0)**



**Version 2.0
(1)**

CHAPTER 9 KEYBOARD WEDGE INTERFACE

Introduction

This chapter describes how to set up a keyboard wedge interface with the scanner. The scanner connects between the keyboard and host computer and translates bar code data into keystrokes, which the host accepts as if they originated from the keyboard. This mode adds bar code reading functionality to a system designed for manual keyboard input. Keyboard keystrokes are simply passed through.

The scanner ships with the settings shown in [Table 9-1 on page 9-3](#) (also see [Appendix A, Standard Parameter Defaults](#) for all defaults). If the default values suit requirements, programming is not necessary.

Setting Parameters

To set feature values, scan a single bar code or a short bar code sequence. The settings are stored in non-volatile memory and are preserved even when the scanner powers down.

✓ **NOTE** Most computer monitors allow scanning bar codes directly on the screen. When scanning from the screen, be sure to set the document magnification to a level where you can see the bar code clearly, and bars and/or spaces do not merge.

To return all features to default values, scan a bar code in *Default Parameters on page 10-5*. Throughout the programming bar code menus, asterisks (*) indicate default values.



* Indicates default *Enable Parameter Feature/option

Scanning Sequence Examples

In most cases, scanning one bar code sets the parameter value. For example, to select a medium keystroke delay, scan the **Medium Delay (20 msec)** bar code under *Keystroke Delay on page 9-5*. The scanner issues a fast warble beep and the LED turns green, signifying a successful parameter entry.

Other parameters require scanning several bar codes. See the parameter descriptions for this procedure.

Errors While Scanning

Unless otherwise specified, to correct an error during a scanning sequence, just re-scan the correct parameter.

Connecting a Keyboard Wedge Interface

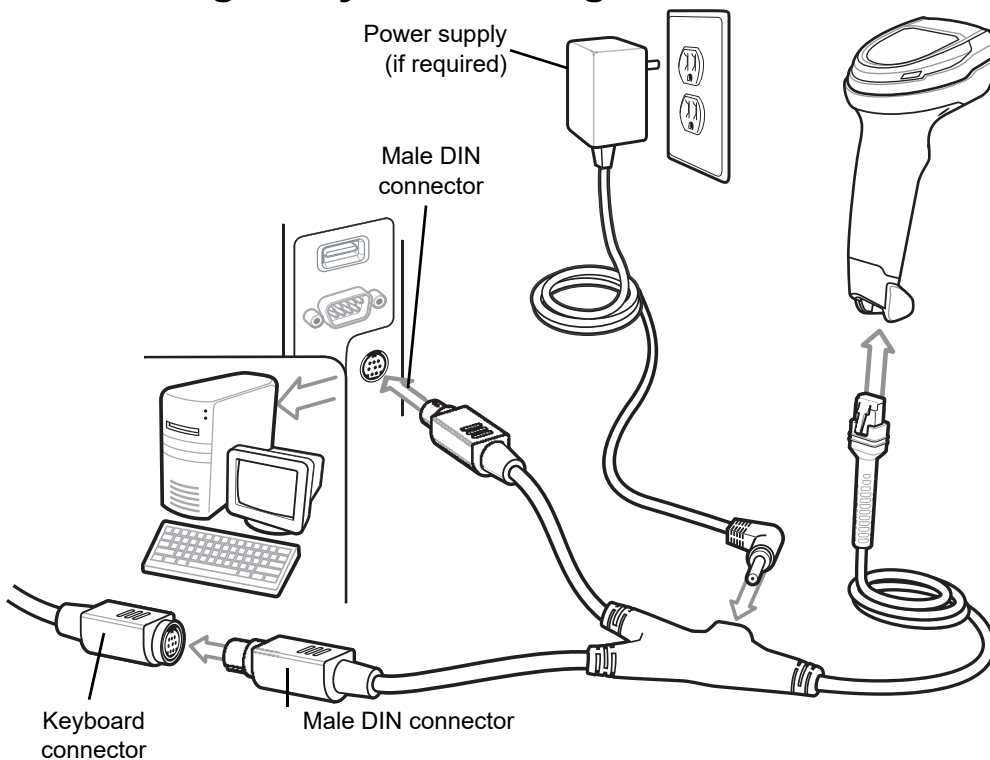

Figure 9-1 Keyboard Wedge Connection

✓ **NOTE** Interface cables vary depending on configuration. The connectors can be different than those illustrated in [Figure 9-1](#), but the steps to connect the scanner are the same.

1. Turn off the host and unplug the keyboard connector.
2. Attach the modular connector of the Y-cable to the cable interface port on the scanner. See [Installing the Interface Cable on page 1-3](#).
3. Connect the round male DIN host connector of the Y-cable to the keyboard port on the host device.
4. Connect the round female DIN keyboard connector of the Y-cable to the keyboard connector.
5. If required, attach the optional power supply to the connector in the middle of the Y-cable.
6. Ensure that all connections are secure.
7. Turn on the host system.
8. The scanner automatically detects the host interface type and uses the default setting. If the default (*) does not meet your requirements, scan *IBM PC/AT & IBM PC Compatibles* on [page 9-4](#).
9. To modify other parameter options, scan the appropriate bar codes in this guide.

If problems occur with the system, see [Troubleshooting on page 4-5](#).

Keyboard Wedge Parameter Defaults

[Table 9-1](#) lists defaults for keyboard wedge host parameters. Change these values in one of two ways:

- Scan the appropriate bar codes in this chapter. The new value replaces the standard default value in memory. To recall default parameter values, see *Default Parameters on page 10-5*.
- Configure the scanner using the 123Scan configuration program. See [Chapter 2, 123Scan and Software Tools](#).

✓ **NOTE** See [Appendix A, Standard Parameter Defaults](#) for all user preference, host, symbology, and miscellaneous default parameters.

Table 9-1 Keyboard Wedge Interface Parameter Defaults

Parameter	Default	Page Number
Keyboard Wedge Host Parameters		
Keyboard Wedge Host Type	IBM AT Notebook	9-4
Bar Codes with Unknown Characters	Send Bar Codes with Unknown Characters	9-4
Keystroke Delay	No Delay	9-5
Intra-keystroke Delay	Disable	9-5
Alternate Numeric Keypad Emulation	Enable	9-6
Quick Keypad Emulation	Enable	9-6
Simulated Caps Lock	Disable	9-7
Caps Lock Override	Disable	9-7
Convert Case	Do Not Convert	9-8
Function Key Mapping	Disable	9-8
FN1 Substitution	Disable	9-9
Send Make and Break	Send Make and Break Scan Codes	9-9

Keyboard Wedge Host Parameters

Keyboard Wedge Host Types

Scan one of the following bar codes to select the keyboard wedge host.



NOTE For a list of supported scanner functionality by communication protocol, see [Appendix F, Communication Protocol Functionality](#).

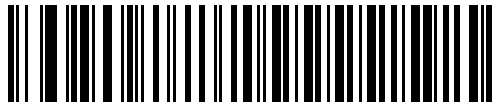

IBM PC/AT & IBM PC Compatibles

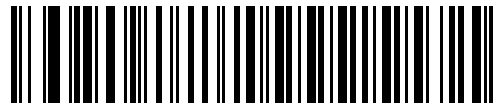

***IBM AT Notebook**

Bar Codes with Unknown Characters

Unknown characters are characters the host does not recognize. Scan **Send Bar Codes With Unknown Characters** to send all bar code data except for unknown characters. The scanner issues no error beeps.

Scan **Do Not Send Bar Codes With Unknown Characters** to send bar code data up to the first unknown character. The scanner issues an error beep.



***Send Bar Codes with Unknown Characters**



Do Not Send Bar Codes with Unknown Characters

Keystroke Delay

This is the delay in milliseconds between emulated keystrokes. Scan one of the following bar codes to increase the delay when hosts require a slower data transmission.



*No Delay



Medium Delay (20 msec)

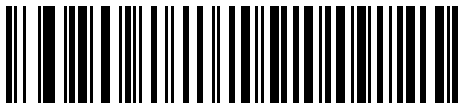

Long Delay (40 msec)

Intra-keystroke Delay

Scan **Enable Intra-keystroke Delay** to insert an additional delay between each emulated key press and release. This also sets *Keystroke Delay* to a minimum of 5 msec.



Enable Intra-keystroke Delay

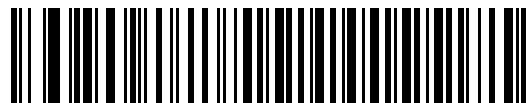

*Disable Intra-keystroke Delay

Alternate Numeric Keypad Emulation

This allows emulation of most other country keyboard types not listed in [Appendix G, Country Codes](#) in a Microsoft® operating system environment.

- ✓ **NOTE** If your keyboard type is not listed in the country code list (see *Country Codes on page G-1*), disable *Quick Keypad Emulation on page 9-6* and ensure *Alternate Numeric Keypad Emulation on page 9-6* is enabled.

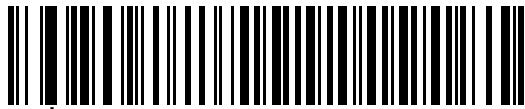

*Enable Alternate Numeric Keypad

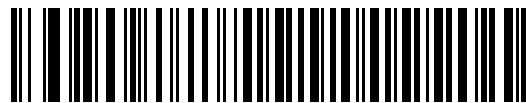

Disable Alternate Numeric Keypad

Quick Keypad Emulation

This enables faster keypad emulation where character value sequences are only sent for characters not found on the keyboard.

- ✓ **NOTE** This option applies only when [Alternate Numeric Keypad Emulation](#) is enabled.

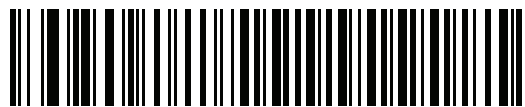

*Enable Quick Keypad Emulation



Disable Quick Keypad Emulation

Simulated Caps Lock

Scan **Enable Caps Lock** to invert upper and lower case characters on the bar code as if the Caps Lock state is enabled on the keyboard. This inversion occurs regardless of the keyboard's Caps Lock state. Note that this only applies to alpha characters.

✓ **NOTE** Simulated Caps Lock applies to ASCII characters only.

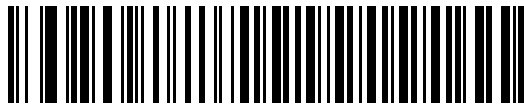

Enable Caps Lock



***Disable Caps Lock**

Caps Lock Override

Scan **Enable Caps Lock Override** for AT or AT Notebook hosts to preserve the case of the data regardless of the state of the Caps Lock key. Therefore, an 'A' in the bar code transmits as an 'A' regardless of the setting of the keyboard's Caps Lock key.



Enable Caps Lock Override



***Disable Caps Lock Override**

✓ **NOTE** If both Simulated Caps Lock and Caps Lock Override are enabled, Caps Lock Override takes precedence.

Convert Case

Scan one of the following bar codes to convert all bar code data to the selected case.

✓ **NOTE** Convert Case applies to ASCII characters only.



Convert to Upper Case



Convert to Lower Case

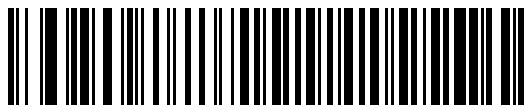

***Do Not Convert**

Function Key Mapping

ASCII values under 32 are normally sent as control key sequences (see [Table D-1 on page D-1](#)). Scan **Enable Function Key Mapping** to send the keys in bold in place of the standard key mapping. Table entries that do not have a bold entry remain the same whether or not you enable this parameter.



Enable Function Key Mapping

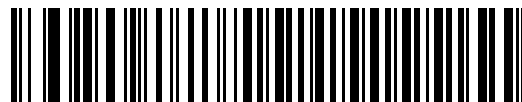

***Disable Function Key Mapping**

FN1 Substitution

Scan **Enable FN1 Substitution** to replace FN1 characters in an EAN128 bar code with a user-selected keystroke (see *FN1 Substitution Values on page 10-39*).

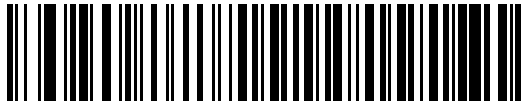

Enable FN1 Substitution

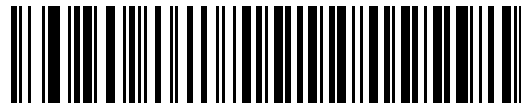

***Disable FN1 Substitution**

Send Make and Break

Scan **Send Make and Break Scan Codes** to prevent sending the scan codes for releasing a key.



***Send Make and Break Scan Codes**

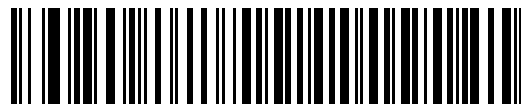

Send Make Scan Code Only



NOTE Windows-based systems must use **Send Make and Break Scan Codes**.

Keyboard Map

The following keyboard map is a reference for prefix/suffix keystroke parameters. To program the prefix/suffix values, see the bar codes on [page 10-36](#).

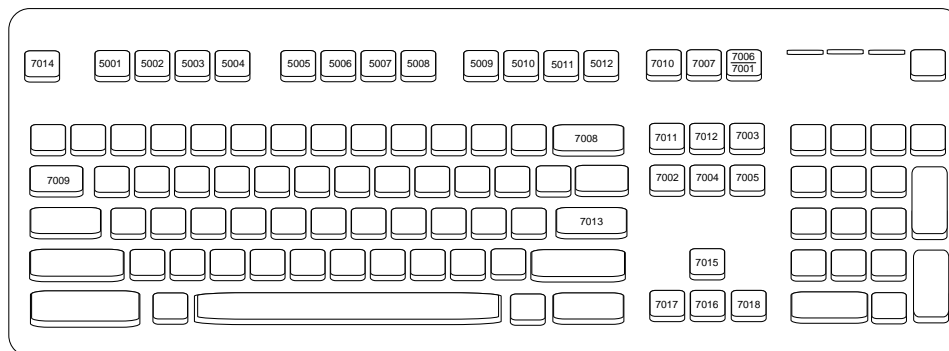

Figure 9-2 IBM PS2 Type Keyboard

ASCII Character Sets

See [Appendix D, ASCII Character Sets](#) for the following information:

- [Table D-1, ASCII Character Set on page D-1](#)
- [Table D-2, ALT Key Character Set on page D-6](#)
- [Table D-3, GUI Key Character Set on page D-7](#)
- [Table D-4, PF Key Character Set on page D-9](#)
- [Table D-5, F Key Character Set on page D-10](#)
- [Table D-6, Numeric Key Character Set on page D-11](#)
- [Table D-7, Extended Key Character Set on page D-12](#)

CHAPTER 10 USER PREFERENCES & MISCELLANEOUS OPTIONS

Introduction

You can program the scanner to perform various functions, or activate different features. This chapter describes user preference features and provides programming bar codes for selecting these features.

The scanner ships with the settings shown in [Table 10-1 on page 10-2](#) (also see [Appendix A, Standard Parameter Defaults](#) for all defaults). If the default values suit requirements, programming is not necessary.

Setting Parameters

To set feature values, scan a single bar code or a short bar code sequence. The settings are stored in non-volatile memory and are preserved even when the scanner powers down.

✓ **NOTE** Most computer monitors allow scanning bar codes directly on the screen. When scanning from the screen, be sure to set the document magnification to a level where you can see the bar code clearly, and bars and/or spaces do not merge.

If not using the default host, select the host type (see each host chapter for specific host information) after the power-up beeps sound. This is only necessary upon the first power-up when connected to a new host.

To return all features to default values, see [Default Parameters on page 10-5](#). Throughout the programming bar code menus, asterisks indicate (*) default values.

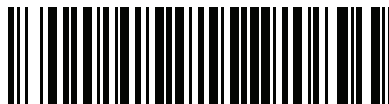

* Indicates default — *Enable Parameter — Feature/option
(1) — Option value

Scanning Sequence Examples

In most cases, scanning one bar code sets the parameter value. For example, to set the beeper tone to high, scan the **High Frequency** (beeper tone) bar code listed under *Beeper Tone on page 10-8*. The scanner issues a fast warble beep and the LED turns green, signifying a successful parameter entry.

Other parameters require scanning several bar codes. See the parameter descriptions for this procedure.

Errors While Scanning

Unless otherwise specified, to correct an error during a scanning sequence, just re-scan the correct parameter.

User Preferences/Miscellaneous Options Parameter Defaults

[Table 10-1](#) lists defaults for user preferences parameters. Change these values in one of two ways:

- Scan the appropriate bar codes in this chapter. The new value replaces the standard default value in memory. To recall default parameter values, see *Default Parameters on page 10-5*.
- Configure the scanner using the 123Scan configuration program. See [Chapter 2, 123Scan and Software Tools](#).

✓ **NOTE** See [Appendix A, Standard Parameter Defaults](#) for all user preference, host, symbology, and miscellaneous default parameters.

Table 10-1 *User Preferences Parameter Defaults*

Parameter	Parameter Number ¹	SSI Number ²	Default	Page Number
User Preferences				
Set Default Parameter	N/A	N/A	N/A	10-5
Parameter Bar Code Scanning	236	ECh	Enable	10-6
Beep After Good Decode	56	38h	Enable	10-6
Beeper Volume	140	8Ch	High	10-7
Beeper Tone	145	91h	Medium	10-8
Beeper Duration	628	F1h 74h	Medium	10-9
Suppress Power Up Beeps	721	F1h D1h	Do Not Suppress	10-10
LED on Good Decode	744	F1h E8h	Enable	10-10
Direct Decode Indicator	859	F2h 5Bh	Disable	10-11
Decode Pager Motor (DS8108-HC only)	613	F1h 65h	Enable	10-12

1. Parameter number decimal values are used for programming via RSM commands.
2. SSI number hex values are used for programming via SSI commands.

Table 10-1 *User Preferences Parameter Defaults (Continued)*

Parameter	Parameter Number ¹	SSI Number ²	Default	Page Number
Decode Pager Motor Duration (DS8108-HC only)	626	F1h 72h	150 msec	10-13
Night Mode Trigger (DS8108-HC only)	1215	F8h 04h BFh	Disable	10-15
Night Mode Toggle (DS8108-HC only)	N/A	N/A	N/A	10-15
Night Mode Silence Parameter Programming Beeper Indications	2264	F8h 08h D8	Enable Always	10-16
Low Power Mode	128	80h	Disable	10-18
Time Delay to Low Power Mode	146	92h	1 Hour	10-19
Trigger Mode (or Hand-held Trigger Mode)	138	8Ah	Auto Aim	10-21
Hands-free Mode	630	F1h 76h	Enable	10-22
Hand-held Decode Aiming Pattern	306	F0h 32h	Enable	10-23
Presentation (Hands-free) Decode Aiming Pattern	590	F1h 4Eh	Enable Presentation (Hands-free) Decode Aiming Pattern on PDF	10-24
Picklist Mode	402	F0h 92h	Disable Picklist Mode Always	10-25
Continuous Bar Code Read	649	F1h 89h	Disable	10-26
Unique Bar Code Reporting	723	F1h D3h	Enable	10-26
Decode Session Timeout	136	88h	9.9 Seconds	10-27
Hands-free Decode Session Timeout	400	F0h 90h	15	10-27
Timeout Between Decodes, Same Symbol	137	89h	0.5 Seconds	10-28
Timeout Between Decodes, Different Symbols	144	90h	0.1 Seconds	10-28
Triggered Timeout, Same Symbol	724	F1h D4h	Disable	10-29
Mobile Phone/Display Mode	716	F1h CCh	Normal	10-30
PDF Prioritization	719	F1h CFh	Disable	10-31
PDF Prioritization Timeout	720	F1h D0h	200 ms	10-31
Presentation (Hands-free) Mode Field of View	609	F1h 61h	Full	10-32
Decoding Illumination	298	F0h 2Ah	Enable	10-32
Illumination Brightness	669	F1h 9Dh	High	10-33

1. Parameter number decimal values are used for programming via RSM commands.
2. SSI number hex values are used for programming via SSI commands.

Table 10-1 *User Preferences Parameter Defaults (Continued)*

Parameter	Parameter Number ¹	SSI Number ²	Default	Page Number
Motion Tolerance (Hand-held Trigger Mode Only)	858	F2h 5Ah	Less	10-34
Miscellaneous Options				
Enter Key	N/A	N/A	N/A	10-34
Tab Key	N/A	N/A	N/A	10-34
Transmit Code ID Character	45	2Dh	None	10-35
Prefix Value	99, 105	63h, 69h	7013 <CR><LF>	10-36
Suffix 1 Value Suffix 2 Value	98, 104 100, 106	62h, 68h 64h, 6Ah	7013 <CR><LF>	10-36
Scan Data Transmission Format	235	EBh	Data As Is	10-37
FN1 Substitution Values	103, 109	67h, 6Dh	7013 <CR><LF>	10-39
Transmit "No Read" Message	94	5E	Disable	10-40
Unsolicited Heartbeat Interval	1118	F8h 04h 5Eh	Disable	10-41
securPharm	1752	F8h 06h D8h	Disable	10-42
securPharm Output Formatting	1753	F8h 06h D9h	No Formatting	10-43

1. Parameter number decimal values are used for programming via RSM commands.
2. SSI number hex values are used for programming via SSI commands.

User Preferences

Default Parameters

Scan one of the following bar codes to reset the scanner to its default settings as follows:

- **Restore Defaults** resets all default parameters as follows:
 - If you configured custom default parameter values via the **Write to Custom Defaults** bar code, scanning the **Restore Defaults** bar code restores these custom values.
 - If you did not configure custom default parameter values, scanning the **Restore Defaults** bar code restores the factory default values. See [Appendix A, Standard Parameter Defaults](#) for these values.
- **Set Factory Defaults** clears all custom default values and sets the factory default values. See [Appendix A, Standard Parameter Defaults](#) for these values.

Write to Custom Defaults

To create a set of custom defaults, select the desired parameter values in this guide, and then scan **Write to Custom Defaults**.



Restore Defaults



Set Factory Defaults



Write to Custom Defaults

Parameter Bar Code Scanning

Parameter # 236

SSI # ECh

Scan one of the following bar codes to select whether to enable or disable the decoding of parameter bar codes, including the **Set Defaults** bar codes.



***Enable Parameter Bar Code Scanning
(1)**



**Disable Parameter Bar Code Scanning
(0)**

Beep After Good Decode

Parameter # 56

SSI # 38h

Scan one of the following bar codes to select whether or not the scanner beeps after a good decode. If you select **Do Not Beep After Good Decode**, the beeper still operates during parameter menu scanning and to indicate error conditions.



***Enable Beep After Good Decode
(1)**



**Disable Beep After Good Decode
(0)**

Beeper Volume

Parameter # 140

SSI # 8Ch

Scan one of the following bar codes to select a beeper volume.



Low Volume
(2)



Medium Volume
(1)



***High Volume**
(0)

Beeper Tone

Parameter # 145

SSI # 91h

Scan one of the following bar codes to select a beeper tone for the good decode beep.



Disable Tone
(3)

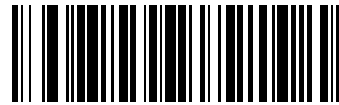

Low Tone
(2)

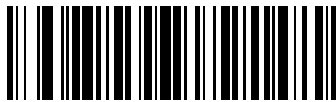

***Medium Tone**
(1)

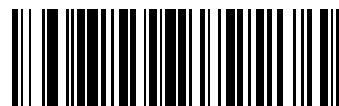

High Tone
(0)



Medium to High Tone (2-tone)
(4)

Beeper Duration

Parameter # 628

SSI # F1h 74h

Scan one of the following bar codes to select the duration for the good decode beep.

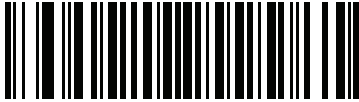

Short Duration
(0)



*Medium Duration
(1)

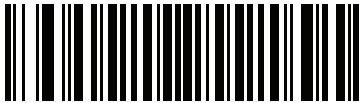

Long Duration
(2)

Suppress Power Up Beeps

Parameter # 721

SSI # F1h D1h

Scan one of the following bar codes to select whether or not to suppress the scanner's power-up beeps.



***Do Not Suppress Power Up Beeps
(0)**



**Suppress Power Up Beeps
(1)**

LED on Good Decode

Parameter # 744

SSI # F1h E8h

Scan one of the following bar codes to select whether or not the LED blinks on a good decode.



***Enable LED on Good Decode
(2)**



**Disable LED on Good Decode
(0)**

Direct Decode Indicator

Parameter # 859

SSI # F2h 5Bh

This parameter is only supported in Auto Aim and Standard (Level) *Hand-held Trigger Mode*. Scan one of the following bar codes to select optional blinking of the illumination on a successful decode if you continue to hold the trigger. If you release the trigger upon decode, the blinking does not occur. This allows you to choose additional feedback for a successful decode by holding the trigger, or to continue to scan as normal.

- ***Disable Direct Decode Indicator** - Illumination does not blink on a successful decode.
- **1 Blink** - Illumination blinks once upon a successful decode.
- **2 Blinks** - Illumination blinks twice upon a successful decode.

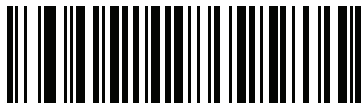

***Disable Direct Decode Indicator
(0)**



**1 Blink
(1)**



**2 Blinks
(2)**

Decode Pager Motor (DS8108-HC Only)

Parameter # 613

SSI # F1h 65h

The scanner includes a pager motor which, when enabled, vibrates the scanner for a period of time when a successful decode occurs.

✓ **NOTE** While the scanner is in the Intellistand, the pager motor is disabled.

Scan one of the following bar codes to enable or disable the pager motor. If enabled, scan a [Decode Pager Motor Duration \(DS8108-HC Only\)](#) bar code to set the duration of the pager motor vibration.



***Enable Pager Motor
(1)**



**Disable Pager Motor
(0)**

Decode Pager Motor Duration (DS8108-HC Only)

Parameter # 626

SSI # F1h 72h

If you enabled *Decode Pager Motor (DS8108-HC Only)*, scan one of the following bar codes to set the duration of the pager motor vibration.

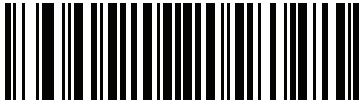

*150 msec
(15)



200 msec
(20)

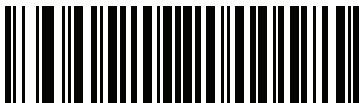

250 msec
(25)



300 msec
(30)

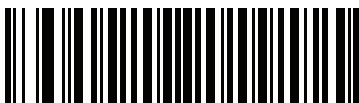

400 msec
(40)



500 msec
(50)

Decode Pager Motor Duration (continued)

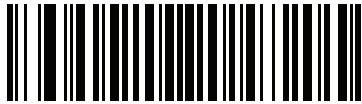

600 msec
(60)



750 msec
(75)

Night Mode (DS8108-HC Only)

The Night Mode feature allows you to easily switch to a “quiet mode” in order to use the pager motor with the beeper off. Enter and exit Night Mode in one of two ways:

- If *Night Mode Trigger (DS8108-HC Only)* is enabled, you can use the trigger to toggle between entering and exiting Night Mode. To do this, point the scanner away from a bar code and press the trigger until the beam goes off. Hold the trigger for an additional 5 seconds.

✓ **NOTE** After decoding a bar code, holding the trigger an additional 5 seconds has no affect.

- Scan the *Night Mode Toggle (DS8108-HC Only)* bar code to enter or exit Night Mode, regardless of the state of the *Night Mode Trigger (DS8108-HC Only)* parameter.

Entering Night Mode enables *Decode Pager Motor (DS8108-HC Only)*, and disables *Beep After Good Decode*.

Also note the following scanner behavior regarding Night Mode:

- Exiting Night Mode returns the scanner to the previously programmed states for the three parameters changed. For example, if *Beep After Good Decode* was enabled before entering Night Mode, it returns to enabled upon exiting Night Mode.
- When entering Night Mode, the pager motor vibrates. When exiting Night Mode, the scanner emits two short beeps.
- Scanning a *Default Parameters* bar code causes the scanner to exit Night Mode.
- For scanners that do not use a pager motor, scanning any of the Night Mode parameters or the pager motor parameters results in an error beep.
- If the scanner loses power while in Night Mode because a cable is disconnected, on the next power up the scanner exits Night Mode and resumes normal operation.

Night Mode Trigger (DS8108-HC Only)

Parameter # 1215

SSI # F8h 04h BFh

Scan **Enable Night Mode Trigger** to use the trigger to toggle between entering and exiting Night Mode. To toggle, point the scanner away from a bar code, press the trigger until the beam goes off, and then hold the trigger for an additional 5 seconds. Note that pressing the trigger an additional 5 seconds after decoding a bar code has no affect.

When entering Night Mode, the pager motor vibrates. When exiting Night Mode, the scanner emits two short beeps.



**Enable Night Mode Trigger
(1)**

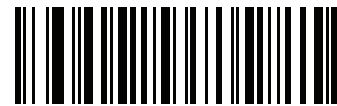

***Disable Night Mode Trigger
(0)**

Night Mode Toggle (DS8108-HC Only)

Scan this bar code to toggle between entering and exiting Night Mode without using the trigger. This functions regardless of the state of the **Night Mode Trigger** parameter.

When entering Night Mode, the pager motor vibrates. When exiting Night Mode, the scanner emits two short beeps.



Toggle Night Mode

Night Mode Silence Parameter Programming Beeper Indications

Parameter # 2264 (SSI # F8h 08h D8)

This parameter enables or disables the Mode Silence Parameter Programming Beeper Indications feature.



Disable Always
(0)

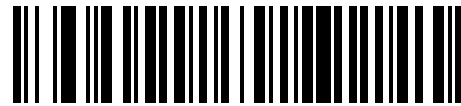

***Enable Always**
(1)



Disable in Night Mode
(2)

When **Disable in Night Mode** or **Disable Always** is active, the following parameter bar code programming beeper indications are silenced:

Parameter Programming Indication Name	Beeper Sequence	Parameter Programming Indication
Input error	Long low/long high	Incorrect bar code or Cancel scanned, wrong entry, incorrect bar code programming sequence; remain in program mode
Keyboard parameter selected	High/low	Enter value using bar code keypad.
Successful programming	High/low/high/low	Successful program exited with change in the parameter setting.
ADF Programming		
Number expected	High/low	Enter another digit. Add leading zeros to the front, if necessary.
Alpha expected	Low/low	Enter another alphabetic character or scan the End of Message bar code.
ADF criteria/action expected	High/high	Enter another criteria or action or scan the Save Rule bar code.
ADF criteria/action cleared	High/low/low	All criteria or actions cleared for current rule, continuing entering rule.

Parameter Programing Indication Name	Beeper Sequence	Parameter Programming Indication
Rule saved	High/low/high/low	Rule successfully saved and rule entry mode exited.
Rule error	Long low/long high	Entry error, wrong bar code scanned, or criteria/action list is too long for a rule. Re-enter criteria or action.
Deleted last saved rule	Low	Deletes the last saved rule but the current rule is left intact.
All rules deleted	Long/high/high	All rules entered are deleted.
Out of memory	Long low/long high/ long low/long high	Out of ADF memory. Erase some existing rules, then try to erase the rule again.
Cancel rule entry	Long low/long high/long low	Rule entry mode exited because of an error or the user asked to exit rule entry.

Low Power Mode

Parameter # 128

SSI # 80h

✓ **NOTE** The Low Power Mode parameter only applies for non-USB and non-RS485 host interfaces, and when *Hand-held Trigger Mode* on page 10-21 is set to **Level (Standard)**.

Scan one of the following bar codes to select whether or not the scanner enters low power mode after a decode attempt or host communication. This applies to serial and keyboard wedge connections. If disabled, power remains on after each decode attempt.

If you enable this, see [Time Delay to Low Power Mode](#) to set the inactivity time period.



**Enable Low Power Mode
(1)**



***Disable Low Power Mode
(0)**

Time Delay to Low Power Mode

Parameter # 146

SSI # 92h

✓ **NOTE** This parameter only applies when *Low Power Mode* is enabled.

Scan one of the following bar codes to set the time the scanner remains active before entering low power mode. The scanner wakes upon trigger press or when the host attempts to communicate with the scanner.



1 Second
(17)

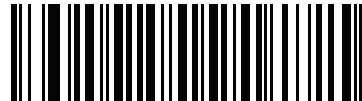

10 Seconds
(26)



1 Minute
(33)



5 Minutes
(37)



15 Minutes
(43)

Time Delay to Low Power Mode (continued)

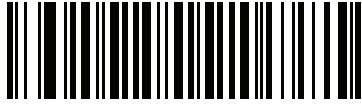

**30 Minutes
(45)**

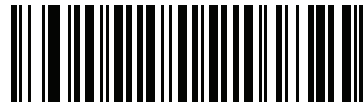

**45 Minutes
(46)**



***1 Hour
(49)**

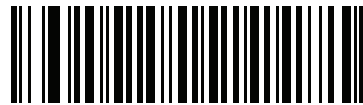

**3 Hours
(51)**



**6 Hours
(54)**



**9 Hours
(57)**

Hand-held Trigger Mode

Parameter # 138

SSI # 8Ah

Scan one of the following bar codes to select a trigger mode for the scanner:

- **Standard (Level)** - A trigger press activates decode processing. Decode processing continues until the bar code decodes, you release the trigger, or the *Decode Session Timeout on page 10-27* occurs.
- **Presentation (Blink)** - The scanner activates decode processing when it detects a bar code in its field of view. After a period of non-use, the LEDs turn off until the scanner senses motion.
- ***Auto Aim** - The scanner projects the aiming pattern when lifted. A trigger press activates decode processing. After a period of inactivity the aiming pattern shuts off.

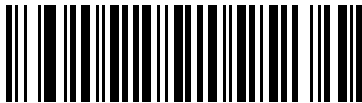

Standard (Level)
(0)



Presentation (Blink)
(7)



***Auto Aim**
(9)

Hands-free Mode

Parameter # 630

SSI # F1h 76h

Scan one of the following bar codes to enable or disable hands-free mode:

- **Enable Hands-free Mode** - When you place the scanner in Intellistand, it automatically triggers when presented with a bar code. Lifting the scanner or pulling the trigger causes it to behave according to the setting of the *Hand-held Trigger Mode on page 10-21*.
- **Disable Hands-free Mode** - The scanner behaves according to the setting of the *Hand-held Trigger Mode on page 10-21* regardless of whether it is hand-held or in Intellistand.

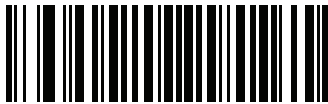

***Enable Hands-free Mode
(1)**



**Disable Hands-free Mode
(0)**

Hand-held Decode Aiming Pattern

Parameter # 306

SSI # F0h 32h

Scan one of the following bar codes to select when to project the aiming pattern in hand-held mode:

- **Enable Hand-held Decode Aiming Pattern** - This projects the aiming pattern during bar code capture.
- **Disable Hand-held Decode Aiming Pattern** - This turns the aiming pattern off.
- **Enable Hand-held Decode Aiming Pattern on PDF** - This projects the aiming pattern when the scanner detects a PDF bar code.

✓ **NOTE** With *Picklist Mode on page 10-25* enabled, the decode aiming pattern flashes even if you disable the **Hand-held Decode Aiming Pattern**.

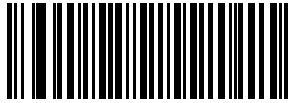

***Enable Hand-held Decode Aiming Pattern**
(2)

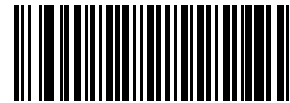

Disable Hand-held Decode Aiming Pattern
(0)

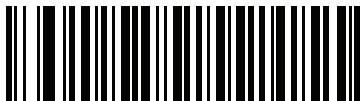

Enable Hand-held Decode Aiming Pattern on PDF
(3)

Presentation (Hands-free) Decode Aiming Pattern

Parameter # 590

SSI # F1h 4Eh

Scan one of the following bar codes to select when to project the aiming pattern in hands-free mode:

- **Enable Presentation (Hands-free) Decode Aiming Pattern** - This projects the aiming pattern during bar code capture.
- **Disable Presentation (Hands-free) Decode Aiming Pattern** - This turns the aiming pattern off.
- **Enable Presentation (Hands-free) Decode Aiming Pattern on PDF** - This projects the aiming pattern when the scanner detects a PDF bar code.

✓ **NOTE** With *Picklist Mode* on page 10-25 enabled, the decode aiming pattern flashes even when you disable the **Hands-free Decode Aiming Pattern**.



**Enable Presentation (Hands-free)
Decode Aiming Pattern
(1)**



**Disable Presentation (Hands-free)
Decode Aiming Pattern
(0)**



***Enable Presentation (Hands-free)
Decode Aiming Pattern on PDF
(2)**

Picklist Mode

Parameter # 402

SSI # F0h 92h

Scan one of the following bar codes to select a Picklist Mode, which allows you to pick and decode a bar code from multiple bar codes printed close together.

- ✓ **NOTE** Enabling Picklist Mode overrides the Disable Decode Aiming Pattern options. You can not disable the decode aiming pattern when Picklist Mode is enabled.

Enabling Picklist Mode can slow decode speed and hinder the ability to decode longer bar codes.

- **Enable Picklist Mode Always** - Picklist Mode is always enabled.
- **Enable Picklist Mode in Hand-held Mode** - Picklist Mode is enabled when the scanner is out of hands-free mode and disabled when the scanner is in presentation mode.
- **Enable Picklist Mode in Hands-free Mode** - Picklist Mode is enabled when the scanner is in hands-free mode only.
- **Disable Picklist Mode Always** - Picklist Mode is always disabled.

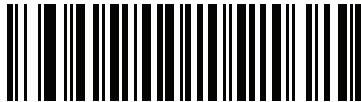

Enable Picklist Mode Always
(2)



Enable Picklist Mode in Hand-held Mode
(1)



Enable Picklist Mode in Hands-free Mode
(3)



***Disable Picklist Mode Always**
(0)

Continuous Bar Code Read

Parameter # 649

SSI # F1h 89h

Scan **Enable Continuous Bar Code Read** to report every bar code while the trigger is pressed.



NOTE We strongly recommend enabling *Picklist Mode* on page 10-25 with this parameter. Disabling Picklist Mode can cause accidental decodes when more than one bar code is in the scanner's field of view.



**Enable Continuous Bar Code Read
(1)**



***Disable Continuous Bar Code Read
(0)**

Unique Bar Code Reporting

Parameter # 723

SSI # F1h D3h

Scan **Enable Continuous Bar Code Read Uniqueness** to report only unique bar codes while the trigger is pressed. This option only applies when *Continuous Bar Code Read* is enabled.



***Enable Unique Bar Code Reporting
(1)**



**Disable Unique Bar Code Reporting
(0)**

Decode Session Timeout

Parameter # 136

SSI # 88h

This parameter sets the maximum time decode processing continues during a scan attempt. It is programmable in 0.1 second increments from 0.5 to 9.9 seconds. The default timeout is 9.9 seconds.

To set a Decode Session Timeout, scan the following bar code, and then scan two bar codes from [Appendix B, Numeric Bar Codes](#) that correspond to the desired on time. Enter a leading zero for single digit numbers. For example, to set a Decode Session Timeout of 0.5 seconds, scan this bar code, and then scan the **0** and **5** bar codes. To correct an error or change the selection, scan *Cancel on page B-3*.



Decode Session Timeout

Hands-free Decode Session Timeout

Parameter # 400

SSI # F0h 90h

This parameter sets the minimum and maximum time decode processing continues during a hands-free scan attempt, and only applies when the scanner is in hands-free trigger mode or the gooseneck stand.

The minimum decode processing time is the time in which the scanner stops decoding when an object is removed or left stationary in the imaging field of view.

The maximum decode processing time is the time in which the scanner stops decoding when an object is left in and is moving in the field of view.

A single setting configures both maximum and minimum times. The relationship of this setting is as follows:

Setting Value	Minimum Time	Maximum Time
$X < 25$	250 ms	$X * 100$ ms
$X \geq 25$	$X * 10$ ms	$X * 100$ ms

For example, a setting value of 100 turns off decoding approximately 1 second after an object is removed from the field of view or 10 seconds when a moving object is in the field of view.

The default value is 15 which results in a minimum time of 250 ms and maximum time of 2.5 seconds.

Adjust this setting based on requirements. For example, for PDF prioritization, set this parameter to a value where the maximum time is above the PDF prioritization timeout.

To set a three-digit timeout value, scan the following bar code, and then scan three bar codes from [Appendix B, Numeric Bar Codes](#) that correspond to the desired value. Enter a leading zero for single digit numbers. To correct an error or change the selection, scan *Cancel on page B-3*.

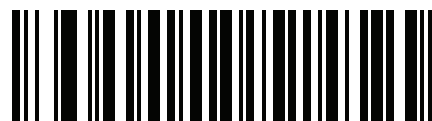

Decode Session Timeout

Timeout Between Decodes, Same Symbol

Parameter # 137

SSI # 89h

Use this option in presentation mode or *Continuous Bar Code Read* mode to prevent the scanner from continuously decoding the same bar code when it is left in the scanner's field of view. The bar code must be out of the field of view for the timeout period before the scanner reads the same consecutive symbol. It is programmable in 0.1 second increments from 0.0 to 9.9 seconds. The default interval is 0.5 seconds.

To select the timeout between decodes for the same symbol, scan the following bar code, and then scan two bar codes from [Appendix B, Numeric Bar Codes](#) that correspond to the desired interval, in 0.1 second increments.



Timeout Between Decodes, Same Symbol

Timeout Between Decodes, Different Symbols

Parameter # 144

SSI # 90h

Use this option in presentation mode or *Continuous Bar Code Read* to control the time the scanner waits before decoding a different symbol. It is programmable in 0.1 second increments from 0.1 to 9.9 seconds. The default is 0.1 seconds.

To select the timeout between decodes for different symbols, scan the following bar code, and then scan two bar codes from [Appendix B, Numeric Bar Codes](#) that correspond to the desired interval, in 0.1 second increments..



NOTE Timeout Between Decodes, Different Symbols cannot be greater than or equal to the *Decode Session Timeout*.



Timeout Between Decodes, Different Symbols

Triggered Timeout, Same Symbol

Parameter # 724 (SSI # F1h D4h)

Scan **Enable Triggered Timeout, Same Symbol** below to apply **Timeout Between Decodes, Same Symbol** (parameter #137 on page [10-28](#)) in hand-held trigger mode. Subsequent scans of **Enable Triggered Timeout, Same Symbol** are ignored until **Timeout Between Decodes, Same Symbol** expires.



NOTE This feature does not apply to Timeout Between Decodes, Different Symbols.



NOTE Timeout Between Decodes, Same Symbol cannot be greater than or equal to the Time Delay to Low Power Mode (parameter #146 on page [10-19](#)).



Enable Triggered Timeout, Same Symbol
(1)



*** Disable Triggered Timeout, Same Symbol**
(0)

Mobile Phone/Display Mode

Parameter # 716

SSI # F1h CCh

This mode improves bar code reading performance off mobile phones and electronic displays. Scan one of the following bar codes to select the desired mode.

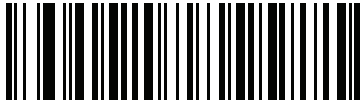

***Normal Mobile Phone/Display Mode
(0)**

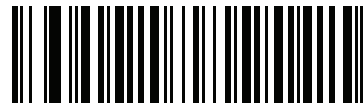

**Enhanced in Hand-held Mode
(1)**



**Enhanced in Hands-free Mode
(2)**



**Enhanced in Both Modes
(3)**

PDF Prioritization

Parameter # 719

SSI # F1h CFh

Scan **Enable PDF Prioritization** to delay decoding certain 1D bar codes (see *Note* below) by the value specified in *PDF Prioritization Timeout*. During that time the scanner attempts to decode a PDF417 symbol (e.g., on a US driver's license), and if successful, reports this only. If it does not decode (can not find) a PDF417 symbol, it reports the 1D symbol after the timeout. The 1D symbol must be in the device's field of view for the scanner to report it. This parameter does not affect decoding other symbologies.

✓ **NOTE** The 1D Code 128 bar code lengths include the following:

- 7 to 10 characters
- 14 to 22 characters
- 27 to 28 characters

In addition, a Code 39 bar code with the following lengths are considered to potentially be part of a US driver's license:

- 8 characters
- 12 characters



**Enable PDF Prioritization
(1)**



***Disable PDF Prioritization
(0)**

PDF Prioritization Timeout

Parameter # 720

SSI # F1h D0h

If you enabled *PDF Prioritization*, set this timeout to indicate how long the scanner attempts to decode a PDF417 symbol before reporting the 1D bar code in the field of view.

Scan the following bar code, and then scan four bar codes from [Appendix B, Numeric Bar Codes](#) that specify the timeout in milliseconds. For example, to enter 400 ms, scan the following bar code, and then scan 0400. The range is 0 to 5000 ms, and the default is 200 ms.



PDF Prioritization Timeout

Presentation (Hands-free) Mode Field of View

Parameter # 609

SSI # F1h 61h

In presentation mode, by default the scanner searches the larger area of the aiming pattern (**Full Field of View**).

Select **Small Field of View** or **Medium Field of View** to search for a bar code in a smaller region around the aiming pattern's center in order to speed search time.

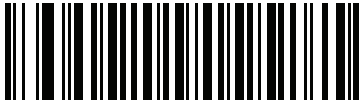

**Small Field of View
(0)**



**Medium Field of View
(1)**

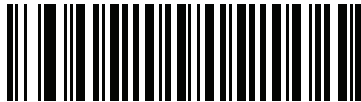

***Full Field of View
(2)**

Decoding Illumination

Parameter # 298

SSI # F0h 2Ah

Scan one of the following bar codes to determine whether the scanner turns on illumination to aid decoding. Enabling illumination usually results in superior images and better decode performance. The effectiveness of the illumination decreases as the distance to the target increases.



***Enable Decoding Illumination
(1)**



**Disable Decoding Illumination
(0)**

Illumination Brightness

Parameter # 669

SSI # F1h 9Dh

Scan one of the following bar codes to set the illumination brightness used during an active decode session. This only applies in hand-held mode (not in presentation mode).

✓ **NOTE** Selecting a lower brightness level can affect decode performance.



Low Illumination Brightness
(0)



Medium Illumination Brightness
(3)



***High Illumination Brightness**
(9)

Motion Tolerance (Hand-held Trigger Modes Only)

Parameter # 858

SSI # F2h 5Ah

Scan one of the following bar codes to select a motion tolerance option:

- **Less Motion Tolerance** - This provides optimal decoding performance on 1D bar codes.
- **More Motion Tolerance** - This increases motion tolerance and speeds decoding when scanning a series of 1D bar codes in rapid progression.



***Less Motion Tolerance
(0)**



**More Motion Tolerance
(1)**

Miscellaneous Scanner Parameters

Enter Key

Scan the following bar code to add an Enter key (carriage return/line feed) after scanned data.
To program other prefixes and/or suffixes, see [Prefix/Suffix Values on page 10-36](#).

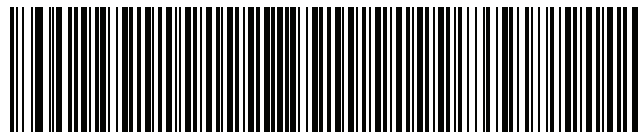

Add Enter Key (Carriage Return/Line Feed)

Tab Key

Scan the following bar code to add a Tab key after scanned data.



Tab Key

Transmit Code ID Character

Parameter # 45

SSI # 2Dh

A Code ID character identifies the code type of a scanned bar code. This is useful when decoding more than one code type. In addition to any single character prefix selected, the Code ID character is inserted between the prefix and the decoded symbol.

Select no Code ID character, a Symbol Code ID character, or an AIM Code ID character. For Code ID characters, see *Symbol Code Identifiers on page E-1* and *AIM Code Identifiers on page E-3*.

✓ **NOTE** If you enable Symbol Code ID Character or AIM Code ID Character, and enable *Transmit "No Read" Message on page 10-40*, the scanner appends the code ID for Code 39 to the NR message.



Symbol Code ID Character
(2)

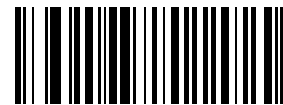

AIM Code ID Character
(1)



*None
(0)

Prefix/Suffix Values

Key Category Parameter # P = 99, S1 = 98, S2 = 100

SSI # P = 63h, S1 = 62h, S2 = 64h

Decimal Value Parameter # P = 105, S1 = 104, S2 = 106

SSI # P = 69h, S1 = 68h, S2 = 6Ah

You can append a prefix and/or one or two suffixes to scan data for use in data editing. To set a value for a prefix or suffix, scan one of the following bar codes, and then scan four bar codes from [Appendix B, Numeric Bar Codes](#) that correspond to that value. See [Appendix D, ASCII Character Sets](#) for the four-digit codes.

When using host commands to set the prefix or suffix, set the key category parameter to 1, and then set the 3-digit decimal value. See [Appendix D, ASCII Character Sets](#) for the four-digit codes.

The default prefix and suffix value is 7013 <CR><LF> (Enter key). To correct an error or change a selection, scan *Cancel* on page B-3.

✓ **NOTE** To use Prefix/Suffix values, first set the *Scan Data Transmission Format* on page 10-37.

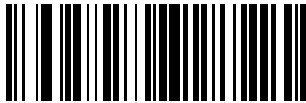

**Scan Prefix
(7)**



**Scan Suffix 1
(6)**



**Scan Suffix 2
(8)**



Data Format Cancel

Scan Data Transmission Format

Parameter # 235

SSI # EBh

To change the scan data format, scan one of the following bar codes corresponding to the desired format.

✓ **NOTE** If using this parameter do not use ADF rules to set the prefix/suffix.

To set values for the prefix and/or suffix, see [Prefix/Suffix Values on page 10-36](#).



***Data As Is**
(0)



<DATA> <SUFFIX 1>
(1)



<DATA> <SUFFIX 2>
(2)



<DATA> <SUFFIX 1> <SUFFIX 2>
(3)

Scan Data Transmission Format (continued)



<PREFIX> <DATA >
(4)



<PREFIX> <DATA> <SUFFIX 1>
(5)



<PREFIX> <DATA> <SUFFIX 2>
(6)



<PREFIX> <DATA> <SUFFIX 1> <SUFFIX 2>
(7)

FN1 Substitution Values

Key Category Parameter # 103

Key Category SSI # 67h

Decimal Value Parameter # 109

Decimal Value SSI # 6Dh

Keyboard wedge and USB HID keyboard hosts support a FN1 substitution feature. Enabling this substitutes any FN1 character (0x1b) in an EAN128 bar code with a value. This value defaults to 7013 <CR><LF> (Enter key).

When using host commands to set the FN1 substitution value, set the key category parameter to 1, and then set the 3-digit keystroke value. See the ASCII Character Set table for the current host interface for the desired value.

To select a FN1 substitution value via bar code menus:

1. Scan the following bar code.

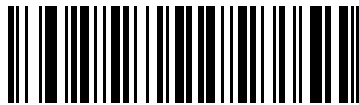

Set FN1 Substitution Value

2. Locate the keystroke desired for FN1 Substitution in the ASCII Character Set table for the current host interface, and enter the 4-digit ASCII value by scanning four bar codes from [Appendix B, Numeric Bar Codes](#).

To correct an error or change the selection, scan **Cancel**.

To enable FN1 substitution for USB HID keyboard, scan **Enable USB Keyboard FN1 Substitution** on page [5-15](#).

To enable FN1 substitution for keyboard wedge, scan **Enable USB Keyboard FN1 Substitution** on page [9-9](#).

Transmit “No Read” Message

Parameter # 94

SSI # 5Eh

Scan one of the following bar codes to set an option for transmitting the No Read (NR) characters:

- ✓ **NOTE** If you enable **Transmit No Read**, and also enable Symbol Code ID Character or AIM Code ID Character for *Transmit Code ID Character on page 10-35*, the scanner appends the code ID for Code 39 to the NR message.
- ✓ **NOTE** This does not apply in presentation mode.
- **Enable No Read** - This transmits the characters NR when a successful decode does not occur before trigger release or the **Decode Session Timeout** expires. See *Decode Session Timeout on page 10-27*.
- **Disable No Read** - This sends nothing to the host if a symbol does not decode.



**Enable No Read
(1)**



***Disable No Read
(0)**

Unsolicited Heartbeat Interval

Parameter # 1118

SSI # F8h 04h 5Eh

The scanner can send unsolicited heartbeat messages to assist in diagnostics. To enable this parameter and set the desired unsolicited heartbeat interval, scan one of the following time interval bar codes, or scan **Set Another Interval** followed by four bar codes from [Appendix B, Numeric Bar Codes](#) that correspond to the desired number of seconds.

Scan **Disable Unsolicited Heartbeat Interval** to turn off the feature.

The heartbeat event is sent as decode data (with no decode beep) in the form of:

MOTEVTHB:nnnn

where **nnnn** is a four-digit sequence number starting at 0001 and wrapping after 9999.

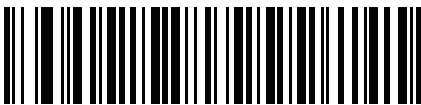

10 Seconds
(10)



1 Minute
(60)



Set Another Interval



***Disable Unsolicited Heartbeat Interval**
(0)

securPharm Decoding

Parameter # 1752 (SSI # F8h 06h D8h)

SecurePharm Decoding implements the IFA and GS1 Coding System for the European pharmaceutical industry. securPharm code is used to prevent pharmaceutical counterfeiting.

When this feature is enabled, if a GS1 symbol is decoded and includes any aspects of the Application Identifier associated with the securPharm GS1 specifications, the entire GS1 symbol is processed as a securPharm symbol. For this reason, it is expected that under certain circumstances, a GS1 bar codes that is a securPharm symbol may not be processed properly; if the GS1 symbol is not created as per the specification. The output cannot be guaranteed as valid.

Although the GS1-128 type and the GS1 DataBar family are not specifically indicated in the IFA specification, they are supported.

The securPharm output is in XML format and can include the product number, serial number, lot number, expiration and Date of Manufacturing. The XML tags can be arranged in any order. Tags that are not in the bar code are omitted.

Scan a bar code below to enable or disable the ability to process pharmaceutical type bar codes.



***Disable securPharm Decoding
(0)**



**Enable securPharm Decoding
(1)**

securPharm Output Formatting

Parameter # 1753 (SSI # F8h 06h D9h)



NOTE securPharm Output Formatting is effective only when *securPharm Decoding* on page 10-42 is enabled. securPharm Output Formatting parameter options represent bit positions. Therefore, any combination of formatting can be used.

When you scan a securPharm Output Formatting bar code, the securPharm output is formatted in a number of ways.

Sample GS1 Format

Product Number: GTIN Data Identifier DI Data Format Identifier: GS1

Data Carrier

FNC104150123456782

101A234B5**FNC1**

1717231

211234567890123456



> Scanned Bar Code >

```
<content dfi="GS1">
<gtin>04150123456782</gtin>
  <lot>1A234B5</lot>
  <exp>151231</exp>
  <sn>1234567890123456</sn>
</content>
```

Sample GS1 Output - Feature Disabled

The output has no format:

```
0104150123456782101A234B517151231211234567890123456
```

Sample GS1 Output - No Formatting (0)

The output is a single line of characters:

```
<content dfi="GS1"><gtin>04150123456782</gtin><lot>1A234B5</lot><exp>151231</exp><sn>1234567890123456</sn></content>
```

Sample GS1 Output - Insert Tab (1)

The output is a single line of characters with a tab inserted in the XML body:

```
<content dfi="GS1">[tab]<gtin>04150123456782</gtin>[tab]<lot>1A234B5</lot>[tab]<exp>151231</exp>[tab]<sn>1234567890123456</sn></content>
```

Sample GS1 Output - Insert New Line (2)

The output consists of multiple lines of characters with a new line character at the end of each line.

```
<content dfi="GS1">
<gtin>04150123456782</gtin>
<lot>1A234B5</lot>
<exp>151231</exp>
<sn>1234567890123456</sn>
</content>
```



Sample GS1 Output - Insert Tab and New Line (3)

The output consists of multiple lines of characters with tabs and a new line character at the end of each line.

```
<content dfi="GS1">
[tab] <gtin>04150123456782</gtin>
[tab] <lot>1A234B5</lot>
[tab] <exp>151231</exp>
[tab] <sn>1234567890123456</sn>
</content>
```

Sample IFA Format

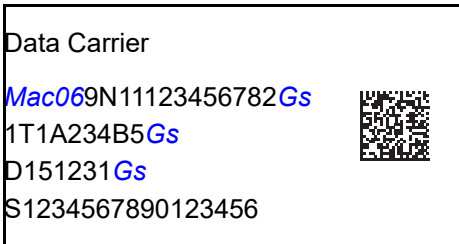
Product Number: PPN Data Identifier DI Data Format Identifier: IFA



> Scanned Bar Code >

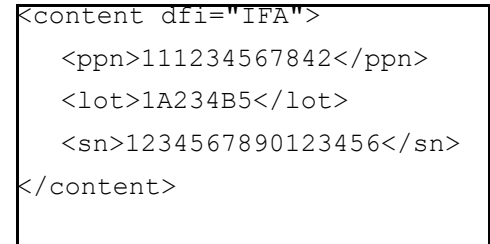

Sample GS1 Output - Feature Disabled

The output has no format:

```
[ ]>069N1112345678421T1A234B5S1234567890123456
```

Sample GS1 Output - No Formatting (0)

The output is a single line of characters:

```
<content dfi="IFA"><ppn>111234567842</ppn><lot>1A234B5</lot><sn>1234567890123456</sn></content>
```

Sample GS1 Output - Insert Tab (1)

The output is a single line of characters with a tab inserted in the XML body:

```
<content dfi="IFA">[tab]<ppn>111234567842</ppn>[tab]<lot>1A234B5</lot>[tab]<sn>1234567890123456</sn></content>
```

Sample GS1 Output - Insert New Line (2)

The output consists of multiple lines of characters with a new line character at the end of each line.

```
<content dfi="IFA">
<ppn>111234567842</ppn>
<lot>1A234B5</lot>
<sn>1234567890123456</sn>
</content>
```

Sample GS1 Output - Insert Tab and New Line (3)

The output consists of multiple lines of characters with tabs and a new line character at the end of each line.

```
<content dfi="IFA">  
[tab] <ppn>111234567842</ppn>  
[tab] <lot>1A234B5</lot>  
[tab] <sn>1234567890123456</sn>  
</content>
```

securPharm Output Formatting Bar Codes

Scan a bar code below to format the securPharm output.



***No Formatting
(0)**



**Insert Tab
(1)**



**Insert New Line
(2)**



**Insert Tab and New Line
(3)**

CHAPTER 11 IMAGE CAPTURE PREFERENCES

Introduction

You can program the imager to perform various functions, or activate different features. This chapter describes image capture preference features and provides programming bar codes for selecting these features.

✓ **NOTE** Only the Symbol Native API (SNAPI) with Imaging interface supports image capture. See *USB Device Type on page 5-6* to enable this host.

The imager ships with the settings shown in [Table 11-1 on page 11-2](#) (also see [Appendix A, Standard Parameter Defaults](#) for all defaults). If the default values suit requirements, programming is not necessary.

Setting Parameters

To set feature values, scan a single bar code or a short bar code sequence. The settings are stored in non-volatile memory and are preserved even when the imager powers down.

✓ **NOTE** Most computer monitors allow scanning bar codes directly on the screen. When scanning from the screen, be sure to set the document magnification to a level where you can see the bar code clearly, and bars and/or spaces do not merge.

To return all features to default values, scan the *Set Factory Defaults on page 10-5*. Throughout the programming bar code menus, asterisks (*) indicate default values.



* Indicates default — *Enable Parameter — Feature/option
(1) — Option value

Scanning Sequence Examples

In most cases scanning one bar code sets the parameter value. For example, to disable image capture illumination, scan the **Disable Image Capture Illumination** bar code under *Image Capture Illumination* on page 11-5. The imager issues a fast warble beep and the LED turns green, signifying a successful parameter entry.

Other parameters require scanning several bar codes. See the parameter descriptions for this procedure.

Errors While Scanning

Unless otherwise specified, to correct an error during a scanning sequence, just re-scan the correct parameter.

Image Capture Preferences Parameter Defaults

[Table 11-1](#) lists defaults for image capture preference parameters. Change these values in one of two ways:

- Scan the appropriate bar codes in this chapter. The new value replaces the standard default value in memory. To recall default parameter values, see *Default Parameters* on page 10-5.
- Configure the scanner using the 123Scan configuration program. See [Chapter 2, 123Scan and Software Tools](#).

✓ **NOTE** See [Appendix A, Standard Parameter Defaults](#) for all user preference, host, symbology, and miscellaneous default parameters.

Table 11-1 *Image Capture Preferences Parameter Defaults*

Parameter	Parameter Number ¹	SSI Number ²	Default	Page Number
Image Capture Preferences				
Operational Modes	N/A	N/A	N/A	11-4
Image Capture Illumination	361	F0h 69h	Enable	11-5
Image Capture Autoexposure	360	F0h 68h	Enable	11-5
Fixed Exposure	567	F4h F1h 37h	100	11-6
Fixed Gain	568	F1h 38h	50	11-6
Gain / Exposure Priority for Snapshot Mode	562	F1h 32h	Autodetect	11-7
Snapshot Mode Timeout	323	F0h 43h	0 (30 seconds)	11-8
Snapshot Aiming Pattern	300	F0h 2Ch	Enable	11-9
Silence Operational Mode Changes	1293	F8h 05h 0Dh	Disable (do not silence)	11-9
Image Cropping	301	F0h 2Dh	Disable	11-10

1. Parameter number decimal values are used for programming via RSM commands.
2. SSI number hex values are used for programming via SSI commands.

Table 11-1 Image Capture Preferences Parameter Defaults (Continued)

Parameter	Parameter Number ¹	SSI Number ²	Default	Page Number
Crop to Pixel Addresses	315 316 317 318	F4h F0h 3Bh F4h F0h 3Ch F4h F0h 3Dh F4h F0h 3Eh	0 top 0 left 959 bottom 1279 right	11-10
Image Size (Number of Pixels)	302	F0h 2Eh	Full	11-12
Image Brightness (Target White)	390	F0h 86h	180	11-13
JPEG Image Options	299	F0h 2Bh	Quality	11-13
JPEG Quality Value	305	F0h 31h	65	11-14
JPEG Size Value	561	F1h 31h	160 kB	11-14
Image Enhancement	564	F1h 34h	Low (1)	11-15
Image File Format Selection	304	F0h 30h	JPEG	11-16
Image Rotation	665	F1h 99h	0	11-17
Bits per Pixel (BPP)	303	F0h 2Fh	8 BPP	11-18
Signature Capture	93	5Dh	Disable	11-19
Signature Capture Image File Format Selection	313	F0h 39h	JPEG	11-20
Signature Capture Bits per Pixel (BPP)	314	F0h 3Ah	8 BPP	11-21
Signature Capture Width	366	F4h F0h 6Eh	400	11-22
Signature Capture Height	367	F4h F0h 6Fh	100	11-22
Signature Capture JPEG Quality	421	F0h A5h	65	11-22
Video View Finder	324	F0h 44h	Disable	11-23
Video View Finder Image Size	329	F0h 49h	1700 bytes	11-23

1. Parameter number decimal values are used for programming via RSM commands.
2. SSI number hex values are used for programming via SSI commands.

Image Capture Preferences

The parameters in this chapter control image capture characteristics.

Operational Modes

The imager has three modes of operation:

- Decode Mode
- Snapshot Mode
- Video Mode.

Decode Mode

By default, when you press the trigger the imager attempts to locate and decode enabled bar codes within its field of view. The imager remains in this mode until it decodes a bar code or you release the trigger.

Snapshot Mode

Use Snapshot Mode to capture a high-quality image and transmit it to the host. Scan the **Snapshot Mode** bar code to temporarily enter this mode. While in this mode the imager blinks the green LED at one-second intervals to indicate it is not in standard operating (decode) mode.

In Snapshot Mode, the imager turns on its aiming pattern to highlight the area to capture in the image. The next trigger press instructs the imager to capture a high quality image and transmit it to the host. A short time may pass (less than two seconds) between when the trigger is pressed and the image is captured as the imager adjusts to lighting conditions. Hold the imager steady until a single beep indicates that it captured the image.

If you do not press the trigger within the Snapshot Mode Timeout period, the imager returns to Decode Mode. Use *Snapshot Mode Timeout on page 11-8* to adjust this timeout period. The default timeout period is 30 seconds.

To disable the aiming pattern during Snapshot Mode, see *Snapshot Aiming Pattern on page 11-9*.



Snapshot Mode

Video Mode

In this mode the imager behaves as a video camera as long as you press the trigger. Release the trigger to return to Decode Mode. Scan this bar code to temporarily enter Video Capture Mode.



Video Mode

Image Capture Illumination

Parameter # 361

SSI # F0h 69h

Scan **Enable Image Capture Illumination** to turn on illumination during every image capture. This usually results in superior images. The effectiveness of illumination decreases as the distance to the target increases.

Scan **Disable Image Capture Illumination** to prevent the imager from using illumination.

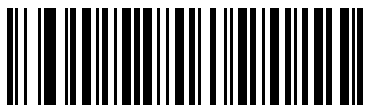

*Enable Image Capture Illumination
(1)

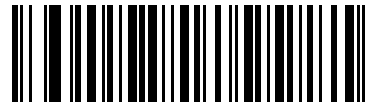

Disable Image Capture Illumination
(0)

Image Capture Autoexposure

Parameter # 360

SSI # F0h 68h

Scan **Enable Image Capture Autoexposure** to allow the imager to control gain settings and exposure (integration) time to best capture an image for the selected operation mode.

Scan **Disable Image Capture Autoexposure** to manually adjust the gain and exposure time (see the following pages). This option is only recommended for advanced users with difficult image capture situations.

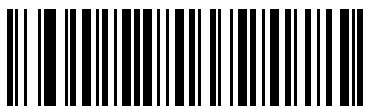

*Enable Image Capture Autoexposure
(1)



Disable Image Capture Autoexposure
(0)

Fixed Exposure

Parameter # 567

SSI # F4h F1h 37h

Type: Word

Range: 5 to 30,000

This parameter configures the exposure used in manual mode for Snapshot and Video modes.

Each integer value represents 100 μ s of exposure. The default value is 100 which results in an exposure setting of 10 ms.

To set the exposure, scan the **Fixed Exposure** bar code, and then scan four numeric bar codes from [Appendix B, Numeric Bar Codes](#) representing the value. Leading zeros are required. For example, to set a Fixed Exposure value of 99, scan 0, 0, 9, 9.



Fixed Exposure
(4 digits)

Fixed Gain

Parameter # 568

SSI # F1h 38h

Type: Byte

Range 1 - 100

This parameter configures the gain setting used in manual mode for Snapshot and Video modes.

A value of 1 indicates that gain is not used for image capture. A value of 100 indicates that maximum gain is used for image capture. The default value of this parameter is 50.

To set the gain, scan the **Fixed Gain** bar code, and then scan three numeric bar codes from [Appendix B, Numeric Bar Codes](#) representing the value. Leading zeros are required. For example, to set a Fixed Gain value of 99, scan 0, 9, 9.



Fixed Gain

Gain/Exposure Priority for Snapshot Mode

Parameter # 562

SSI # F1h 32h

This parameter alters the imager's gain exposure priority when it acquires an image in Snapshot Mode while in autoexposure mode. Scan one of the following bar codes:

- **Low Exposure Priority** - The imager favors higher gain over exposure to capture an image, resulting in an image that is less susceptible to motion blur at the expense of noise artifacts. However, for most applications, the amount of noise is acceptable.
- **Low Gain Priority** - The imager favors longer exposure time rather than higher gain to capture an image, ensuring the image is less noisy and produces fewer artifacts during post processing activities like image enhancement (sharpening). This mode is recommended for fixed mount / fixed object image capture since the image acquired is susceptible to motion blur.
- **Autodetect** (default) - The imager automatically selects Gain Priority or Low Exposure Priority mode for Snapshot Mode. If the imager is in a magnetic reed switch-enabled stand (or it is configured in Blink Mode), it uses Low Gain Priority. Otherwise, it uses the Low Exposure Priority.



Low Gain Priority
(0)



Low Exposure Priority
(1)



***Autodetect**
(2)

Snapshot Mode Timeout

Parameter # 323

SSI # F0h 43h

This parameter sets the amount of time the imager remains in Snapshot Mode. The imager exits Snapshot Mode when you press the trigger, or when the Snapshot Mode Timeout elapses. To set this timeout value, scan the **Set Snapshot Mode Timeout** bar code, and then scan a bar code from [Appendix B, Numeric Bar Codes](#). The default value is 0 which represents 30 seconds; values increment by 30. For example, 0 = 30 seconds, 1 = 60 seconds, 2 = 90 seconds, etc. The maximum timeout value that can be set on the scanner is 9 = 300 seconds.

To quickly re-set the default timeout to 30 seconds, scan the **30 Seconds** bar code.

If you scan **No Timeout**, the imager remains in Snapshot Mode until you press the trigger.



Set Snapshot Mode Timeout

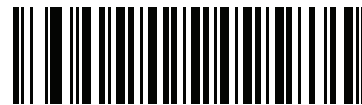

***30 Seconds**



No Timeout

Snapshot Aiming Pattern

Parameter # 300

SSI # F0h 2Ch

Scan one of the following bar codes to select whether or not to project the aiming pattern when in Snapshot Mode.



NOTE If enabled, the aiming pattern frames the image for aiming purposes and does not appear in the captured image.



***Enable Snapshot Aiming Pattern
(1)**



**Disable Snapshot Aiming Pattern
(0)**

Silence Operational Mode Changes

Parameter # 1293

SSI # F8h 05h 0Dh

Scan **Silence Operational Mode Changes** to silence the beeper when switching between operational modes (e.g., from Decode Mode to Snapshot Mode).



**Silence Operational Mode Changes (Enable)
(1)**

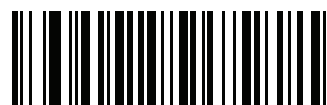

***Do Not Silence Operational Mode Changes (Disable)
(0)**

Image Cropping

Parameter # 301

SSI # F0h 2Dh

Scan the **Enable Image Cropping** bar code to crop a captured image to the pixel addresses set in *Crop to Pixel Addresses* on page 11-10. Scan **Disable Image Cropping** to present the full 1280 x 960 pixels.



**Enable Image Cropping
(1)**



***Disable Image Cropping
(Use Full 1280 x 960 Pixels)
(0)**

Crop to Pixel Addresses

Parameter # 315

SSI # F4h F0h 3Bh (Top)

Parameter # 316

SSI # F4h F0h 3Ch (Left)

Parameter # 317

SSI # F4h F0h 3Dh (Bottom)

Parameter # 318

SSI # F4h F0h 3Eh (Right)

If you enabled *Image Cropping*, set the pixel addresses from (0,0) to (1279 x 959) to crop to.

Columns are numbered from 0 to 1279, rows from 0 to 959. Specify values for Top, Left, Bottom, and Right, where Top and Bottom correspond to row pixel addresses, and Left and Right correspond to column pixel addresses. For example, for a 4 row x 8 column image in the extreme bottom-right section of the image, set the following values:

Top = 796, Bottom = 959, Left = 1272, Right = 1279

To set the pixel addresses, scan each of the following bar codes, and then scan four numeric bar codes from [Appendix B, Numeric Bar Codes](#) representing the value. Leading zeros are required. For example, to crop the top pixel address to 3, scan 0, 0, 0, 3. The defaults are:

Top = 0, Bottom = 959, Left = 0, Right = 1279

✓ **NOTE** The imager has a cropping resolution of 4 pixels. Setting the cropping area to less than 4 pixels (after resolution adjustment, see *Image Size (Number of Pixels) on page 11-12*) transfers the entire image.

Crop to Pixel Address (continued)



Top Pixel Address
(0 - 959 Decimal)

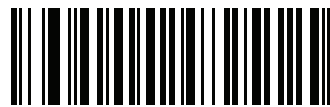

Left Pixel Address
(0 - 1279 Decimal)



Bottom Pixel Address
(0 - 959 Decimal)



Right Pixel Address
(0 - 1279 Decimal)

Image Size (Number of Pixels)

Parameter # 302

SSI # F0h 2Eh

This option alters image resolution before compression. Multiple pixels are combined to one pixel, resulting in a smaller image containing the original content with reduced resolution.

Scan one of the following bar codes to select an image size:

Table 11-2 *Image Size*

Resolution Value	Uncropped Image Size
Full	1280 x 960
1/2	640 x 480
1/4	320 x 240



***Full Resolution
(0)**



**1/2 Resolution
(1)**



**1/4 Resolution
(3)**

Image Brightness (Target White)

Parameter # 390

SSI # F0h 86h

Type: Byte

Range: 1 - 240

This parameter sets the Target White value used in Snapshot and Video Viewfinder modes when using autoexposure. White and black are defined as 240 decimal and 1, respectively. Setting the value to the factory default of 180 sets the white level of the image to ~180.

Scan the **Image Brightness** bar code, and then scan three numeric bar codes from [Appendix B, Numeric Bar Codes](#) representing the value. Leading zeros are required. For example, to set an Image Brightness value of 99, scan 0, 9, 9.



*180



**Image Brightness
(3 digits)**

JPEG Image Options

Parameter # 299

SSI # F0h 2Bh

Scan one of the following bar codes to optimize JPEG images for either size or quality:

- **JPEG Quality Selector** - Enter a quality value via the [JPEG Quality Value](#) parameter; the imager then selects the corresponding image size.
- **JPEG Size Selector** - Enter a size value via the [JPEG Size Value](#) parameter; the imager then selects the best image quality.



*JPEG Quality Selector
(1)



**JPEG Size Selector
(0)**

JPEG Quality Value

Parameter # 305

SSI # F0h 31h

If you selected **JPEG Quality Selector**, scan the **JPEG Quality Value** bar code, and then scan three bar codes from [Appendix B, Numeric Bar Codes](#) corresponding to a value from 5 to 100, where 100 represents the highest quality image. Leading zeros are required. For example, to set an image quality value of 55, scan 0, 5, 5.



JPEG Quality Value
(Default: 065)
(5 - 100 Decimal)

JPEG Size Value

Parameter # 561

SSI # F1h 31h

Type: Word

Range: 5-350

If you selected **JPEG Size Selector**, scan the **JPEG Size Value** bar code, and then scan three numeric bar codes from [Appendix B, Numeric Bar Codes](#) representing the target JPEG file size in kilobytes (KB). Leading zeros are required. For example, to set an image file size value of 99, scan 0, 9, 9.



CAUTION JPEG compression may take 10 to 15 seconds based on the amount of information in the target image. Scanning **JPEG Quality Selector** (default setting) on [page 11-13](#) produces a compressed image that is consistent in quality and compression time.



JPEG Size Value
(Default: 160)
(3 digits)

Image Enhancement

Parameter # 564

SSI # F1h 34h

This parameter uses a combination of edge sharpening and contrast enhancement to produce an image that is visually pleasing.

Scan one of the following bar codes to select the level of image enhancement:

- Off (0)
- Low (1) - Default
- Medium (2)
- High (3)



Off
(0)



***Low**
(1)



Medium
(2)



High
(3)

Image File Format Selector

Parameter # 304

SSI # F0h 30h

Scan one of the following bar codes to select an image format appropriate for the system (BMP, TIFF, or JPEG). The imager stores captured images in the selected format.



**BMP File Format
(3)**



***JPEG File Format
(1)**



**TIFF File Format
(04h)**

Image Rotation

Parameter # 665

SSI # F1h 99h

Scan one of the following bar codes to rotate the image 0, 90,180, or 270 degrees.

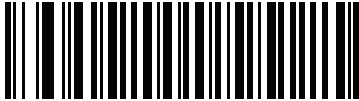

***Rotate 0°
(0)**



**Rotate 90°
(1)**



**Rotate 180°
(2)**

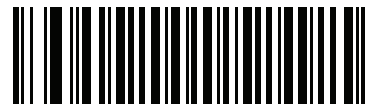

**Rotate 270°
(3)**

Bits Per Pixel

Parameter # 303

SSI # F0h 2Fh

Scan one of the following bar codes to select the number of significant bits per pixel (BPP) to use when capturing an image:

- **1 BPP** - For a black and white image.
- **4 BPP** - Assigns 1 of 16 levels of grey to each pixel.
- **8 BPP** - Assigns 1 of 256 levels of grey to each pixel.

✓ **NOTE** The imager ignores these settings for JPEG file formats, which only support **8 BPP**.

TIFF file formats only support **4 BPP** and **8 BPP**. Selecting **1 BPP** for TIFF applies the **4 BPP** option.



1 BPP
(0)



4 BPP
(1)



***8 BPP**
(2)

Signature Capture

Parameter # 93

SSI # 5Dh

A signature capture bar code is a special-purpose symbology which delineates a signature capture area in a document with a machine-readable format. The recognition pattern is variable so it can optionally provide an index to various signatures. The region inside the bar code pattern is considered the signature capture area. See [Appendix J, Signature Capture Code](#) for more information.

Output File Format

Decoding a signature capture bar code de-skews the signature image and converts the image to a BMP, JPEG, or TIFF file format. The output data includes the file descriptor followed by the formatted signature image.

Table 11-3 *Output File Format*

File Descriptor			Signature Image
Output Format (1 byte)	Signature Type (1 byte)	Signature Image Size (4 bytes) (BiG Endian)	
JPEG - 1 BMP - 3 TIFF - 4	1-8	0x00000400	0x00010203....

Scan one of the following bar codes to enable or disable Signature Capture.



**Enable Signature Capture
(1)**



***Disable Signature Capture
(0)**

Signature Capture File Format Selector

Parameter # 313

SSI # F0h 39h

Scan one of the following bar codes to select a signature file format appropriate for the system (BMP, TIFF, or JPEG). The imager stores captured signatures in the selected format.



BMP Signature Format
(3)



***JPEG Signature Format**
(1)



TIFF Signature Format
(4)

Signature Capture Bits Per Pixel

Parameter # 314

SSI # F0h 3Ah

Scan one of the following bar codes to select the number of significant bits per pixel (BPP) to use when capturing a signature:

- **1 BPP** - For a black and white image.
- **4 BPP** - Assigns 1 of 16 levels of grey to each pixel.
- **8 BPP** - Assigns 1 of 256 levels of grey to each pixel.

✓ **NOTE** The imager ignores these settings for JPEG file formats, which only support **8 BPP**.



1 BPP
(0)



4 BPP
(1)



***8 BPP**
(2)

Signature Capture Width

Parameter # 366

SSI # F4h F0h 6Eh

The aspect ratio of the Signature Capture Width and Signature Capture Height parameters must match that of the signature capture area. For example, a 4 x 1 inch signature capture area requires a 4 to 1 aspect ratio of width to height.

To set the width of the signature capture box, scan the **Signature Capture Width** bar code, and then scan four bar codes from [Appendix B, Numeric Bar Codes](#) corresponding to a value in the range of 16 to 1280 decimal.



Signature Capture Width (Default: 400)
(16 - 1280 Decimal)

Signature Capture Height

Parameter # 367

SSI # F4h F0h 6Fh

To set the height of the signature capture box, scan the **Signature Capture Height** bar code, and then scan three bar codes from [Appendix B, Numeric Bar Codes](#) corresponding to a value in the range of 16 to 960 decimal.



Signature Capture Height (Default: 100)
(16 - 960 Decimal)

Signature Capture JPEG Quality

Parameter # 421

SSI # F0h A5h

Scan the **JPEG Quality Value** bar code, and then scan three bar codes from [Appendix B, Numeric Bar Codes](#) corresponding to a value from 005 to 100, where 100 represents the highest quality image.



JPEG Quality Value (Default: 065)
(5 - 100 Decimal)

Video View Finder

Parameter # 324

SSI # F0h 44h

Scan one of the following bar codes to select whether to project the video view finder while in Snapshot Mode.

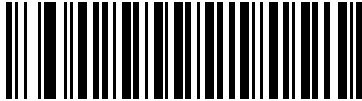

**Enable Video View Finder
(1)**

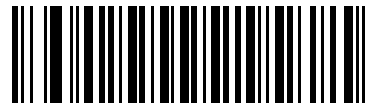

***Disable Video View Finder
(0)**

Video View Finder Image Size

Parameter # 329

SSI # F0h 49h

This parameter sets the number of 100-byte blocks. Values range from 800 to 12,000 bytes. A smaller value transmits more frames per second, while a larger value increases video quality.

Scan the **Video View Finder Image Size** bar code, and then scan three bar codes from [Appendix B, Numeric Bar Codes](#) corresponding to the 100-byte value from 800 to 12,000 bytes. For example, to select 1500 bytes, enter 0, 1, 5. To select 900 bytes, enter 0, 0, 9. The default is 1700 bytes.



Video View Finder Image Size

Video View Finder Image Size (continued)



**Full Resolution
(0)**



**1/2 Resolution
(1)**



***1/4 Resolution
(3)**

CHAPTER 12 SYMBOLOGIES

Introduction

You can program the scanner to perform various functions, or activate different features. This chapter describes symbology features and provides programming bar codes for selecting these features.

The scanner ships with the settings shown in [Table 12-1 on page 12-2](#) (also see [Appendix A, Standard Parameter Defaults](#) for all defaults). If the default values suit requirements, programming is not necessary.

Setting Parameters

To set feature values, scan a single bar code or a short bar code sequence. The settings are stored in non-volatile memory and are preserved even when the scanner powers down.

✓ **NOTE** Most computer monitors allow scanning bar codes directly on the screen. When scanning from the screen, be sure to set the document magnification to a level where you can see the bar code clearly, and bars and/or spaces do not merge.

If not using a USB cable, select a host type (see each host chapter for specific host information) after the power-up beeps sound. This is only necessary upon the first power-up when connected to a new host.

To return all features to default values, see [Default Parameters on page 10-5](#). Throughout the programming bar code menus, asterisks (*) indicate default values.



* Indicates default *Enable Parameter Feature/option

Scanning Sequence Examples

In most cases, scanning one bar code sets the parameter value. For example, to transmit bar code data without the UPC-A check digit, scan the **Do Not Transmit UPC-A Check Digit** bar code under *Transmit UPC-A Check Digit on page 12-20*. The scanner issues a fast warble beep and the LED turns green, signifying a successful parameter entry.

Other parameters require scanning several bar codes. See the parameter descriptions for this procedure.

Errors While Scanning

Unless otherwise specified, to correct an error during a scanning sequence, just re-scan the correct parameter.

Symbology Parameter Defaults

[Table 12-1](#) lists defaults for all symbology parameters. Change these values in one of two ways:

- Scan the appropriate bar codes in this chapter. The new value replaces the standard default value in memory. To recall the default parameter values, see [Default Parameters on page 10-5](#).
- Configure the scanner using the 123Scan configuration program. See [Chapter 2, 123Scan and Software Tools](#).

✓ **NOTE** See [Appendix A, Standard Parameter Defaults](#) for all user preference, host, symbology, and miscellaneous default parameters.

Table 12-1 Symbology Parameter Defaults

Parameter	Parameter Number ¹	SSI Number ²	Default	Page Number
Enable/Disable All Code Types				12-9
1D Symbologies				
UPC/EAN/JAN				
UPC-A	1	01h	Enable	12-10
UPC-E	2	02h	Enable	12-10
UPC-E1	12	0Ch	Disable	12-11
EAN-8/JAN 8	4	04h	Enable	12-11
EAN-13/JAN 13	3	03h	Enable	12-12
Bookland EAN	83	53h	Disable	12-12
Bookland ISBN Format	576	F1h 40h	ISBN-10	12-13
ISSN EAN	617	F1h 69h	Disable	12-14

1. Parameter number decimal values are used for programming via RSM commands.
2. SSI number hex values are used for programming via SSI commands.

Table 12-1 Symbology Parameter Defaults (Continued)

Parameter	Parameter Number ¹	SSI Number ²	Default	Page Number
Decode UPC/EAN/JAN Supplementals (2 and 5 digits)	16	10h	Ignore	12-15
User-Programmable Supplementals			000	12-18
Supplemental 1:	579	F1h 43h		
Supplemental 2:	580	F1h 44h		
UPC/EAN/JAN Supplemental Redundancy	80	50h	10	12-18
Decode UPC/EAN/JAN Supplemental AIM ID	672	F1h A0h	Combined	12-19
Transmit UPC-A Check Digit	40	28h	Enable	12-20
Transmit UPC-E Check Digit	41	29h	Enable	12-20
Transmit UPC-E1 Check Digit	42	2Ah	Enable	12-21
UPC-A Preamble	34	22h	System Character	12-22
UPC-E Preamble	35	23h	System Character	12-23
UPC-E1 Preamble	36	24h	System Character	12-24
Convert UPC-E to A	37	25h	Disable	12-25
Convert UPC-E1 to A	38	26h	Disable	12-25
EAN/JAN Zero Extend	39	27h	Disable	12-26
UCC Coupon Extended Code	85	55h	Disable	12-26
Coupon Report	730	F1h DAh	New Coupon Format	12-27
UPC Reduced Quiet Zone	1289	F8h 05h 09h	Disable	12-28
Code 128				
Code 128	8	08h	Enable	12-29
Set Length(s) for Code 128	209, 210	D1h, D2h	Any Length	12-29
GS1-128 (formerly UCC/EAN-128)	14	0Eh	Enable	12-31
ISBT 128	84	54h	Enable	12-31
ISBT Concatenation	577	F1h 41h	Disable - for SR/DL models Enable - for HC models	12-32
Check ISBT Table	578	F1h 42h	Enable	12-33

1. Parameter number decimal values are used for programming via RSM commands.
2. SSI number hex values are used for programming via SSI commands.

Table 12-1 Symbology Parameter Defaults (Continued)

Parameter	Parameter Number ¹	SSI Number ²	Default	Page Number
ISBT Concatenation Redundancy	223	DFh	10	12-33
Ignore Code 128 <FNC4>	1254	F8h 04h E6h	Honor	12-34
Code 128 Security Level	751	F1h EFh	Security Level 1	12-35
Code 128 Reduced Quiet Zone	1208	F8h 04h B8h	Disable	12-37
Code 39				
Code 39	0	00h	Enable	12-38
Trioptic Code 39	13	0Dh	Disable	12-38
Convert Code 39 to Code 32 (Italian Pharmacy Code)	86	56h	Disable	12-39
Code 32 Prefix	231	E7h	Disable	12-39
Set Length(s) for Code 39	18, 19	12h, 13h	1 to 55	12-40
Code 39 Check Digit Verification	48	30h	Disable	12-41
Transmit Code 39 Check Digit	43	2Bh	Disable	12-42
Code 39 Full ASCII Conversion	17	11h	Disable	12-42
Code 39 Security Level	750	F1h EEh	Security Level 1	12-43
Code 39 Reduced Quiet Zone	1209	F8h 04h B9h	Disable	12-45
Code 93				
Code 93	9	09h	Enable	12-46
Set Length(s) for Code 93	26, 27	1Ah, 1Bh	1 to 55	12-46
Code 11				
Code 11	10	0Ah	Disable	12-48
Set Lengths for Code 11	28, 29	1Ch, 1Dh	4 to 55	12-48
Code 11 Check Digit Verification	52	34h	Disable	12-50
Transmit Code 11 Check Digit(s)	47	2Fh	Disable	12-51
Interleaved 2 of 5 (ITF)				
Interleaved 2 of 5 (ITF)	6	06h	Enable	12-52
Set Lengths for I 2 of 5	22, 23	16h, 17h	6 to 55	12-52
I 2 of 5 Check Digit Verification	49	31h	Disable	12-54
Transmit I 2 of 5 Check Digit	44	2Ch	Disable	12-55

1. Parameter number decimal values are used for programming via RSM commands.
2. SSI number hex values are used for programming via SSI commands.

Table 12-1 Symbology Parameter Defaults (Continued)

Parameter	Parameter Number ¹	SSI Number ²	Default	Page Number
Convert I 2 of 5 to EAN 13	82	52h	Disable	12-55
I 2 of 5 Security Level	1121	F8h 04h 61h	Security Level 1	12-56
I 2 of 5 Reduced Quiet Zone	1210	F8h 04h BAh	Disable	12-57
Discrete 2 of 5 (DTF)				
Discrete 2 of 5	5	05h	Disable	12-58
Set Length(s) for D 2 of 5	20, 21	14h 15h	1 to 55	12-58
Codabar (NW - 7)				
Codabar	7	07h	Enable	12-60
Set Lengths for Codabar	24, 25	18h, 19h	4 to 55	12-60
CLSI Editing	54	36h	Disable	12-62
NOTIS Editing	55	37h	Disable	12-62
Codabar Security Level	1776	F8h 06h F0h	Security Level 1	12-63
Codabar Upper or Lower Case Start/ Stop Characters Detection	855	F2h 57h	Upper Case	12-64
MSI				
MSI	11	0Bh	Disable	12-65
Set Length(s) for MSI	30, 31	1Eh, 1Fh	4 to 55	12-65
MSI Check Digits	50	32h	One	12-67
Transmit MSI Check Digit	46	2Eh	Disable	12-67
MSI Check Digit Algorithm	51	33h	Mod 10/Mod 10	12-69
MSI Reduced Quiet Zone	1392	F8h 05h 70h	Disable	12-69
Chinese 2 of 5				
Chinese 2 of 5	408	F0h 98h	Disable	12-70
Matrix 2 of 5				
Matrix 2 of 5	618	F1h 6Ah	Disable	12-71
Matrix 2 of 5 Lengths	619 620	F1h 6Bh F1h 6Ch	4 to 55	12-71
Matrix 2 of 5 Check Digit	622	F1h 6Eh	Disable	12-73
Transmit Matrix 2 of 5 Check Digit	623	F1h 6Fh	Disable	12-73

**1. Parameter number decimal values are used for programming via RSM commands.
2. SSI number hex values are used for programming via SSI commands.**

Table 12-1 Symbology Parameter Defaults (Continued)

Parameter	Parameter Number ¹	SSI Number ²	Default	Page Number
Korean 3 of 5				
Korean 3 of 5	581	F1h 45h	Disable	12-74
Inverse 1D	586	F1h 4Ah	Regular	12-75
GS1 DataBar				
GS1 DataBar Omnidirectional (formerly GS1 DataBar-14), GS1 DataBar Truncated, GS1 DataBar Stacked, GS1 DataBar Stacked Omnidirectional	338	F0h 52h	Enable	12-76
GS1 DataBar Limited	339	F0h 53h	Enable	12-77
GS1 DataBar Expanded, GS1 DataBar Expanded Stacked	340	F0h 54h	Enable	12-77
Convert GS1 DataBar to UPC/EAN/JAN	397	F0h 8Dh	Disable	12-78
GS1 DataBar Security Level	1706	F8h 06h AAh	Level 1	12-79
GS1 DataBar Limited Margin Check	728	F1h D8h	Level 3	12-80
Symbology-Specific Security Features				
Redundancy Level	78	4Eh	1	12-81
Security Level	77	4Dh	1	12-83
1D Quiet Zone Level	1288	F8h 05h 08h	1	12-84
Intercharacter Gap Size	381	F0h 7Dh	Normal	12-85
Composite Codes				
Composite CC-C	341	F0h 55h	Disable	12-86
Composite CC-A/B	342	F0h 56h	Disable	12-86
Composite TLC-39	371	F0h 73h	Disable	12-87
Composite Inverse	1113	F8h 04h 59h	Regular Only	12-87
UPC Composite Mode	344	F0h 58h	UPC Never Linked	12-88
Composite Beep Mode	398	F0h 8Eh	Beep As Each Code Type is Decoded	12-89
GS1-128 Emulation Mode for UCC/EAN Composite Codes	427	F0h ABh	Disable	12-89

1. Parameter number decimal values are used for programming via RSM commands.
2. SSI number hex values are used for programming via SSI commands.

Table 12-1 Symbology Parameter Defaults (Continued)

Parameter	Parameter Number ¹	SSI Number ²	Default	Page Number
2D Symbologies				
PDF417	15	0Fh	Enable	12-90
MicroPDF417	227	E3h	Disable	12-90
Code 128 Emulation	123	7Bh	Disable	12-91
Data Matrix	292	F0h 24h	Enable	12-92
GS1 Data Matrix	1336	F8h 05h 38h	Disable	12-92
Data Matrix Inverse	588	F1h 4Ch	Inverse Autodetect	12-93
Decode Data Matrix Mirror Images	537	F1h 19h	Auto	12-94
Maxicode	294	F0h 26h	Disable	12-95
QR Code	293	F0h 25h	Enable	12-96
GS1 QR	1343	F8h 05h 3Fh	Disable	12-96
MicroQR	573	F1h 3Dh	Enable	12-97
Linked QR Mode	1847	737h	Linked QR Only	12-98
Aztec	574	F1h 3Eh	Enable	12-99
Aztec Inverse	589	F1h 4Dh	Inverse Autodetect	12-100
Han Xin	1167	F8h 04h 8Fh	Disable	12-101
Han Xin Inverse	1168	F8h 04h 90h	Regular	12-102
Grid Matrix	1718	F8h 06h B6h	Disable	12-103
Grid Matrix Inverse	1719	F8h 06h B7h	Regular Only	12-103
Grid Matrix Mirror	1736	F8h 06h C8h	Regular Only	12-104
DotCode	1906	F8 07 72h	Disable	12-105
DotCode Inverse	1907	F8 07 73h	Autodetect	12-106
DotCode Mirrored	1908	F8 07 74h	Autodetect	12-107
DotCode Prioritize	1937	F8 07 91h	Disable	12-108
Macro PDF				
Flush Macro PDF Buffer	N/A	N/A	N/A	12-109
Abort Macro PDF Entry	N/A	N/A	N/A	12-109

1. Parameter number decimal values are used for programming via RSM commands.
2. SSI number hex values are used for programming via SSI commands.

Table 12-1 Symbology Parameter Defaults (Continued)

Parameter	Parameter Number ¹	SSI Number ²	Default	Page Number
Postal Codes				
US Postnet	89	59h	Disable	12-110
US Planet	90	5Ah	Disable	12-110
Transmit US Postal Check Digit	95	5Fh	Enable	12-111
UK Postal	91	5Bh	Disable	12-111
Transmit UK Postal Check Digit	96	60h	Enable	12-112
Japan Postal	290	F0h 22h	Disable	12-112
Australia Post	291	F0h 23h	Disable	12-113
Australia Post Format	718	F1h CEh	Autodiscriminate	12-114
Netherlands KIX Code	326	F0h 46h	Disable	12-115
USPS 4CB/One Code/Intelligent Mail	592	F1h 50h	Disable	12-115
UPU FICS Postal	611	F1h 63h	Disable	12-116
Mailmark	1337	F8h 05h 39h	Disable	12-116

1. Parameter number decimal values are used for programming via RSM commands.
2. SSI number hex values are used for programming via SSI commands.

Enable/Disable All Code Types

Scan the **Disable All Code Types** bar code to disable all symbologies. This is useful when enabling only a few code types.

Scan **Enable All Code Types** to enable all symbologies. This is useful if you need to disable only a few code types.

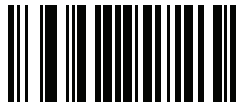

Disable All Code Types



Enable All Code Types

UPC/EAN/JAN

UPC-A

Parameter # 1

SSI # 01h

Scan one of the following bar codes to enable or disable UPC-A.

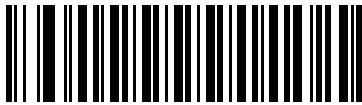

***Enable UPC-A
(1)**

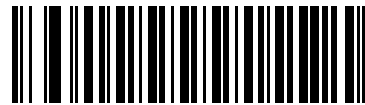

**Disable UPC-A
(0)**

UPC-E

Parameter # 2

SSI # 02h

Scan one of the following bar codes to enable or disable UPC-E.

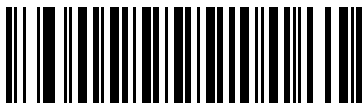

***Enable UPC-E
(1)**



**Disable UPC-E
(0)**

UPC-E1

Parameter # 12
SSI # 0Ch

Scan one of the following bar codes to enable or disable UPC-E1.

✓ **NOTE** UPC-E1 is not a UCC (Uniform Code Council) approved symbology.

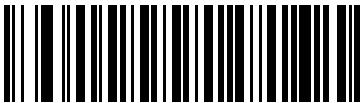

Enable UPC-E1
(1)

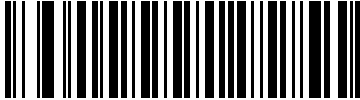

***Disable UPC-E1**
(0)

EAN-8/JAN-8

Parameter # 4
SSI # 04h

Scan one of the following bar codes to enable or disable EAN-8/JAN-8.

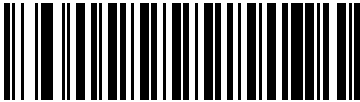

***Enable EAN-8/JAN-8**
(1)

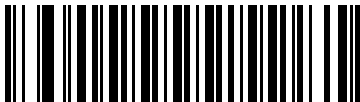

Disable EAN-8/JAN-8
(0)

EAN-13/JAN-13

Parameter # 3

SSI # 03h

Scan one of the following bar codes to enable or disable EAN-13/JAN-13.

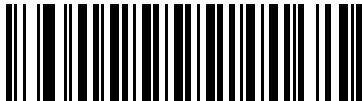

***Enable EAN-13/JAN-13
(1)**



**Disable EAN-13/JAN-13
(0)**

Bookland EAN

Parameter # 83

SSI # 53h

Scan one of the following bar codes to enable or disable Bookland EAN.

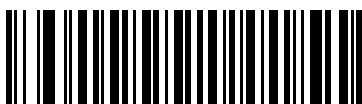

**Enable Bookland EAN
(1)**



***Disable Bookland EAN
(0)**



NOTE If you enable Bookland EAN, select a [Bookland ISBN Format](#). Also set *Decode UPC/EAN/JAN Supplementals* on page 12-15 to either *Decode UPC/EAN/JAN with Supplementals Only*, *Autodiscriminate UPC/EAN/JAN With Supplementals*, or *Enable 978/979 Supplemental Mode*.

Bookland ISBN Format

Parameter # 576

SSI # F1h 40h

If you enabled Bookland EAN using *Bookland EAN on page 12-12*, select one of the following formats for Bookland data:

- **Bookland ISBN-10** - The scanner reports Bookland data starting with 978 in traditional 10-digit format with the special Bookland check digit for backward-compatibility. Data starting with 979 is not considered Bookland in this mode.
- **Bookland ISBN-13** - The scanner reports Bookland data (starting with either 978 or 979) as EAN-13 in 13-digit format to meet the 2007 ISBN-13 protocol.



*Bookland ISBN-10
(0)



Bookland ISBN-13
(1)



NOTE For Bookland EAN to function properly, first enable Bookland EAN using *Bookland EAN on page 12-12*, and then set *Decode UPC/EAN/JAN Supplementals on page 12-15* to either Decode UPC/EAN/JAN with Supplementals Only, Autodiscriminate UPC/EAN/JAN With Supplementals, or Enable 978/979 Supplemental Mode.

ISSN EAN

Parameter # 617

SSI # F1h 69h

Scan one of the following bar codes to enable or disable ISSN EAN.

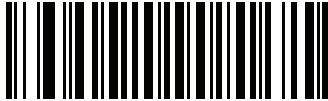

Enable ISSN EAN
(1)

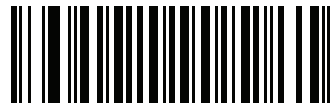

*Disable ISSN EAN
(0)

Decode UPC/EAN/JAN Supplementals

Parameter # 16

SSI # 10h

Supplementals are bar codes appended according to specific format conventions (e.g., UPC A+2, UPC E+2, EAN 13+2). The following options are available:

- **Decode UPC/EAN/JAN with Supplementals Only** - The scanner only decodes UPC/EAN/JAN symbols with supplemental characters, and ignores symbols without supplementals.
- **Ignore UPC/EAN/JAN Supplementals** - When presented with a UPC/EAN/JAN plus supplemental symbol, the scanner decodes UPC/EAN/JAN and ignores the supplemental characters.
- **Autodiscriminate UPC/EAN/JAN with Supplementals** - The scanner decodes UPC/EAN/JAN symbols with supplemental characters immediately. If the symbol does not have a supplemental, the scanner must decode the bar code the number of times set via [UPC/EAN/JAN Supplemental Redundancy on page 12-18](#) before transmitting its data to confirm that there is no supplemental.

Select one of the following **Supplemental Mode** options to immediately transmit EAN-13 bar codes starting with that prefix that have supplemental characters. If the symbol does not have a supplemental, the scanner must decode the bar code the number of times set via [UPC/EAN/JAN Supplemental Redundancy on page 12-18](#) before transmitting the data to confirm that there is no supplemental. The scanner transmits UPC/EAN/JAN bar codes that do not have that prefix immediately.

- **Enable 378/379 Supplemental Mode**
- **Enable 978/979 Supplemental Mode**

✓ **NOTE** If you select 978/979 Supplemental Mode and are scanning Bookland EAN bar codes, see *Bookland EAN on page 12-12* to enable Bookland EAN, and select a format using *Bookland ISBN Format on page 12-13*.

- **Enable 977 Supplemental Mode**
- **Enable 414/419/434/439 Supplemental Mode**
- **Enable 491 Supplemental Mode**
- **Enable Smart Supplemental Mode** - This applies to EAN-13 bar codes starting with any prefix listed previously.
- **Supplemental User-Programmable Type 1** - This applies to EAN-13 bar codes starting with a 3-digit user-defined prefix. Set this using *User-Programmable Supplementals on page 12-18*.
- **Supplemental User-Programmable Type 1 and 2** - This applies to EAN-13 bar codes starting with either of two 3-digit user-defined prefixes. Set the prefixes using *User-Programmable Supplementals on page 12-18*.
- **Smart Supplemental Plus User-Programmable 1** - This applies to EAN-13 bar codes starting with any prefix listed previously or the prefix set using *User-Programmable Supplementals on page 12-18*.
- **Smart Supplemental Plus User-Programmable 1 and 2** - This applies to EAN-13 bar codes starting with any prefix listed previously or one of the two user-defined prefixes set using *User-Programmable Supplementals on page 12-18*.

✓ **NOTE** To minimize the risk of invalid data transmission, select either to decode or ignore supplemental characters.

Decode UPC/EAN/JAN Supplementals (continued)



**Decode UPC/EAN/JAN With Supplementals Only
(1)**



***Ignore UPC/EAN/JAN Supplementals
(0)**

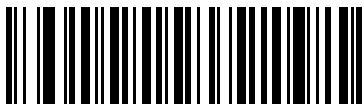

**Autodiscriminate UPC/EAN/JAN with Supplementals
(2)**

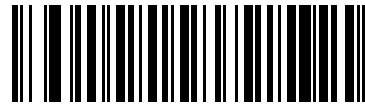

**Enable 378/379 Supplemental Mode
(4)**



**Enable 978/979 Supplemental Mode
(5)**



**Enable 977 Supplemental Mode
(7)**

Decode UPC/EAN/JAN Supplementals (continued)

**Enable 414/419/434/439 Supplemental Mode
(6)**



**Enable 491 Supplemental Mode
(8)**



**Enable Smart Supplemental Mode
(3)**



**Supplemental User-Programmable Type 1
(9)**



**Supplemental User-Programmable Type 1 and 2
(10)**



**Smart Supplemental Plus User-Programmable 1
(11)**



**Smart Supplemental Plus User-Programmable 1 and 2
(12)**

User-Programmable Supplementals

Supplemental 1: Parameter # 579

SSI # F1h 43h

Supplemental 2: Parameter # 580

SSI # F1h 44h

If you selected a Supplemental User-Programmable option from *Decode UPC/EAN/JAN Supplementals on page 12-15*, scan **User-Programmable Supplemental 1**, and then scan three bar codes from [Appendix B, Numeric Bar Codes](#) to set the 3-digit prefix. To set a second 3-digit prefix, scan **User-Programmable Supplemental 2**, and then scan three bar codes from [Appendix B, Numeric Bar Codes](#). The default is 000 (zeroes).



User-Programmable Supplemental 1



User-Programmable Supplemental 2

UPC/EAN/JAN Supplemental Redundancy

Parameter # 80

SSI # 50h

If you selected **Autodiscriminate UPC/EAN/JAN with Supplementals**, this option sets the number of times to decode a symbol without supplementals before transmission. The range is from **two to 30**. Five or above is recommended when decoding a mix of UPC/EAN/JAN symbols with and without supplementals. The default is **10**.

To set a redundancy value, scan the following bar code, and then scan two bar codes from [Appendix B, Numeric Bar Codes](#). Enter a leading zero for single digit numbers. To correct an error or change a selection, scan [Cancel on page B-3](#).



UPC/EAN/JAN Supplemental Redundancy

UPC/EAN/JAN Supplemental AIM ID Format

Parameter # 672

SSI # F1h A0h

If *Transmit Code ID Character on page 10-35* is set to **AIM Code ID Character**, scan one of the following bar codes to select an output format when reporting UPC/EAN/JAN bar codes with supplementals:

- **Separate** - Transmit UPC/EAN/JAN with supplementals with separate AIM IDs but one transmission, i.e.,
]E<0 or 4><data>]E<1 or 2>[supplemental data]
- **Combined** – Transmit UPC/EAN/JAN with supplementals with one AIM ID and one transmission, i.e.,
]E3<data+supplemental data>
- **Separate Transmissions** - Transmit UPC/EAN/JAN with supplementals with separate AIM IDs and separate transmissions, i.e.,
]E<0 or 4><data>
]E<1 or 2>[supplemental data]



**Separate
(0)**



***Combined
(1)**



**Separate Transmissions
(2)**

Transmit UPC-A Check Digit

Parameter # 40

SSI # 28h

The check digit is the last character of the symbol used to verify the integrity of the data. Scan one of the following bar codes to transmit the bar code data with or without the UPC-A check digit. It is always verified to guarantee the integrity of the data.

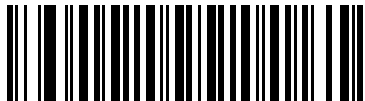

***Transmit UPC-A Check Digit
(1)**

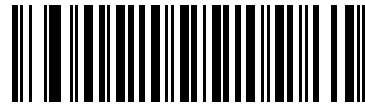

**Do Not Transmit UPC-A Check Digit
(0)**

Transmit UPC-E Check Digit

Parameter # 41

SSI # 29h

The check digit is the last character of the symbol used to verify the integrity of the data. Scan one of the following bar codes to transmit the bar code data with or without the UPC-E check digit. It is always verified to guarantee the integrity of the data.

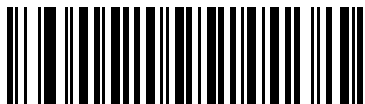

***Transmit UPC-E Check Digit
(1)**



**Do Not Transmit UPC-E Check Digit
(0)**

Transmit UPC-E1 Check Digit

Parameter # 42

SSI # 2Ah

The check digit is the last character of the symbol used to verify the integrity of the data. Scan one of the following bar codes to transmit the bar code data with or without the UPC-E1 check digit. It is always verified to guarantee the integrity of the data.

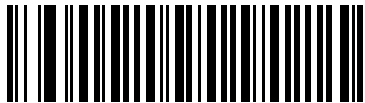

***Transmit UPC-E1 Check Digit
(1)**

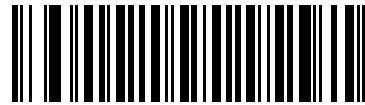

**Do Not Transmit UPC-E1 Check Digit
(0)**

UPC-A Preamble

Parameter # 34

SSI # 22h

Preamble characters are part of the UPC symbol, and include Country Code and System Character. Select the appropriate option for transmitting a UPC-A preamble to match the host system:

- Transmit System Character only
- Transmit System Character and Country Code ("0" for USA)
- Transmit no preamble.

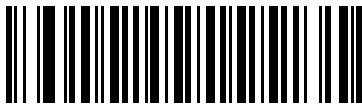

No Preamble (<DATA>)
(0)

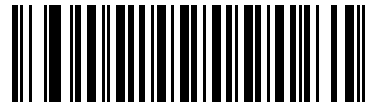

***System Character**
(<SYSTEM CHARACTER> <DATA>)
(1)

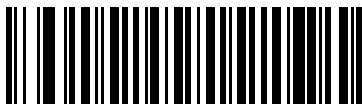

System Character & Country Code
(< COUNTRY CODE> <SYSTEM CHARACTER> <DATA>)
(2)

UPC-E Preamble

Parameter # 35

SSI # 23h

Preamble characters are part of the UPC symbol, and include Country Code and System Character. Select the appropriate option for transmitting a UPC-E preamble to match the host system:

- Transmit System Character only
- Transmit System Character and Country Code (“0” for USA)
- Transmit no preamble.

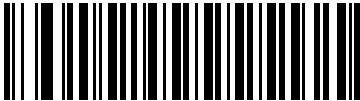

No Preamble (<DATA>)
(0)

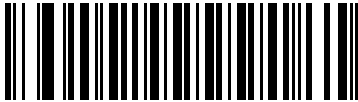

***System Character**
(<SYSTEM CHARACTER> <DATA>)
(1)

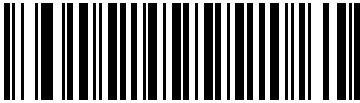

System Character & Country Code
(< COUNTRY CODE> <SYSTEM CHARACTER> <DATA>)
(2)

UPC-E1 Preamble

Parameter # 36

SSI # 24h

Preamble characters are part of the UPC symbol, and include Country Code and System Character. Select the appropriate option for transmitting a UPC-E1 preamble to match the host system:

- Transmit System Character only
- Transmit System Character and Country Code ("0" for USA)
- Transmit no preamble.

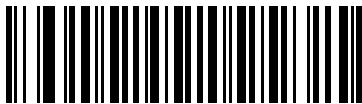

No Preamble (<DATA>)
(0)



***System Character**
(<SYSTEM CHARACTER> <DATA>)
(1)

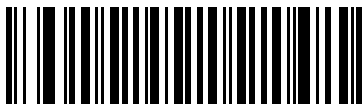

System Character & Country Code
(< COUNTRY CODE> <SYSTEM CHARACTER> <DATA>)
(2)

Convert UPC-E to UPC-A

Parameter # 37

SSI # 25h

Enable this to convert UPC-E (zero suppressed) decoded data to UPC-A format before transmission. After conversion, the data follows UPC-A format and is affected by UPC-A programming selections (e.g., Preamble, Check Digit).

Disable this to transmit UPC-E decoded data as UPC-E data, without conversion.

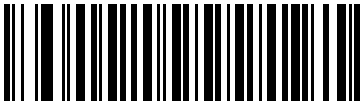

Convert UPC-E to UPC-A (Enable)
(1)

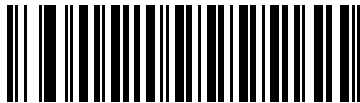

*Do Not Convert UPC-E to UPC-A (Disable)
(0)

Convert UPC-E1 to UPC-A

Parameter # 38

SSI # 26h

Scan **Convert UPC-E1 to UPC-A (Enable)** to convert UPC-E1 decoded data to UPC-A format before transmission. After conversion, the data follows UPC-A format and is affected by UPC-A programming selections (e.g., Preamble, Check Digit).

Scan **Do Not Convert UPC-E1 to UPC-A (Disable)** to transmit UPC-E1 decoded data as UPC-E1 data, without conversion.

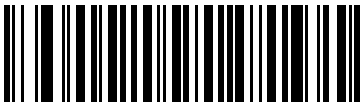

Convert UPC-E1 to UPC-A (Enable)
(1)

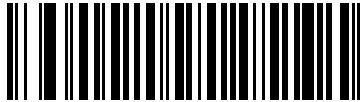

*Do Not Convert UPC-E1 to UPC-A (Disable)
(0)

EAN/JAN Zero Extend

Parameter # 39

SSI # 27h

Scan **Enable EAN/JAN Zero Extend** to add five leading zeros to decoded EAN-8 symbols to make them compatible in length to EAN-13 symbols. Scan **Disable EAN/JAN Zero Extend** to transmit EAN-8 symbols as is.

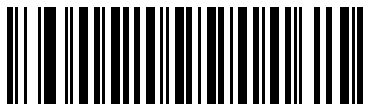

Enable EAN/JAN Zero Extend
(1)



*Disable EAN/JAN Zero Extend
(0)

UCC Coupon Extended Code

Parameter # 85

SSI # 55h

Scan **Enable UCC Coupon Extended Code** to decode UPC-A bar codes starting with digit '5', EAN-13 bar codes starting with digit '99', and UPC-A/GS1-128 coupon codes. UPC-A, EAN-13, and GS1-128 must be enabled to use this feature.

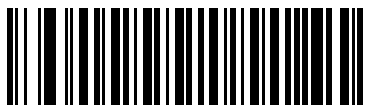

Enable UCC Coupon Extended Code
(1)



*Disable UCC Coupon Extended Code
(0)



NOTE See *UPC/EAN/JAN Supplemental Redundancy* on page 12-18 to control autodiscrimination of the GS1-128 portion (right half) of a coupon code.

Coupon Report

Parameter # 730

SSI # F1h DAh

Scan one of the following bar codes to select the type of coupon format to support.

- **Old Coupon Format** - Support UPC-A/GS1-128 and EAN-13/GS1-128.
- **New Coupon Format** - An interim format to support UPC-A/GS1-DataBar and EAN-13/GS1-DataBar.
- **Autodiscriminate Format** - Support both **Old Coupon Format** and **New Coupon Format**.



Old Coupon Format
(0)

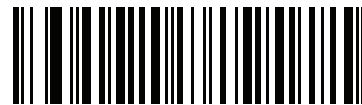

***New Coupon Format**
(1)



Autodiscriminate Coupon Format
(2)

UPC Reduced Quiet Zone

Parameter # 1289

SSI # F8h 05h 09h

Scan one of the following bar codes to enable or disable decoding UPC bar codes with reduced quiet zones (the margins on either side of the bar code). If you select **Enable**, select a *1D Quiet Zone Level* on page 12-84.



Enable UPC Reduced Quiet Zone
(1)

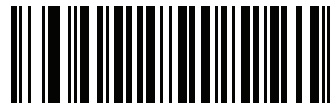

***Disable UPC Reduced Quiet Zone**
(0)

Code 128

Parameter # 8

SSI # 08h

Scan one of the following bar codes to enable or disable Code 128.

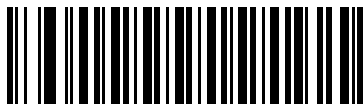

***Enable Code 128
(1)**



**Disable Code 128
(0)**

Set Lengths for Code 128

L1 = Parameter # 209

SSI # D1h

L2 = Parameter # 210

SSI # D2h

The length of a code refers to the number of characters (i.e., human readable characters), including check digit(s) the code contains. Set lengths for Code 128 to any length, one or two discrete lengths, or lengths within a specific range. The default **Any Length**.

✓ **NOTE** When setting lengths, enter a leading zero for single digit numbers.

Scan one of the following bar codes to select a length option:

- **One Discrete Length** - Decode only Code 128 symbols containing a selected length. Select the length using the bar codes in [Appendix B, Numeric Bar Codes](#). For example, to decode only Code 128 symbols with 14 characters, scan **Code 128 - One Discrete Length**, and then scan **1, 4**. To correct an error or change the selection, scan [Cancel on page B-3](#).
- **Two Discrete Lengths** - Decode only Code 128 symbols containing either of two lengths. Select lengths using the bar codes in [Appendix B, Numeric Bar Codes](#). For example, to decode only Code 128 symbols containing either 2 or 14 characters, scan **Code 128 - Two Discrete Lengths**, and then scan **0, 2, 1, 4**. To correct an error or change the selection, scan [Cancel on page B-3](#).
- **Length Within Range** - Decode Code 128 symbols with a specific length range. Select lengths using the bar codes in [Appendix B, Numeric Bar Codes](#). For example, to decode Code 128 symbols containing between 4 and 12 characters, scan **Code 128 - Length Within Range**, and then scan **0, 4, 1, 2**. To correct an error or change the selection, scan [Cancel on page B-3](#).

Set Lengths for Code 128 (continued)

- **Any Length** - Decode Code 128 symbols containing any number of characters within the scanner's capability.

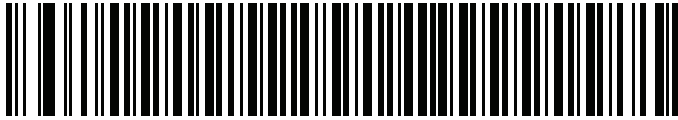

Code 128 - One Discrete Length

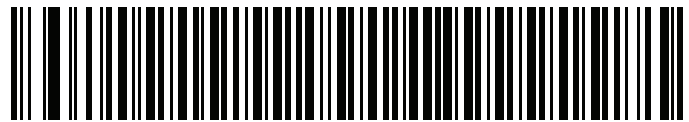

Code 128 - Two Discrete Lengths

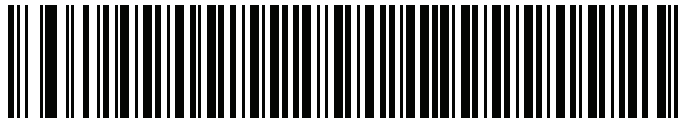

Code 128 - Length Within Range

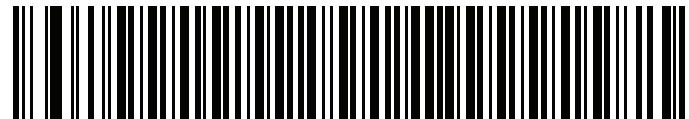

*Code 128 - Any Length

GS1-128 (formerly UCC/EAN-128)**Parameter # 14****SSI # 0Eh**

Scan one of the following bar codes to enable or disable GS1-128.

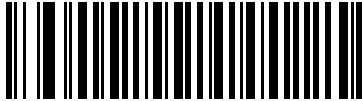

***Enable GS1-128
(1)**

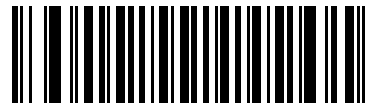

**Disable GS1-128
(0)**

ISBT 128**Parameter # 84****SSI # 54h**

ISBT 128 is a variant of Code 128 used in the blood bank industry. Scan one of the following bar codes to enable or disable ISBT 128.



***Enable ISBT 128
(1)**

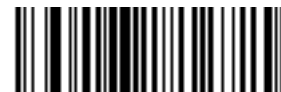

**Disable ISBT 128
(0)**

ISBT Concatenation

Parameter # 577

SSI # F1h 41h

Select an option for concatenating pairs of ISBT code types:

- **Enable ISBT Concatenation** - There must be two ISBT codes in order for the scanner to decode and perform concatenation. The scanner does not decode single ISBT symbols.
- **Disable ISBT Concatenation** - The scanner does not concatenate pairs of ISBT codes it encounters.
- **Autodiscriminate ISBT Concatenation** - The scanner decodes and concatenates pairs of ISBT codes immediately. If only a single ISBT symbol is present, the scanner must decode the symbol the number of times set via [ISBT Concatenation Redundancy on page 12-33](#) before transmitting its data to confirm that there is no additional ISBT symbol.



NOTES The default for SR/DL configurations of the scanner is **Disable ISBT Concatenation**.

The default for Healthcare configurations of the scanner is **Enable ISBT Concatenation**.

When enabling ISBT Concatenation or Autodiscriminate ISBT Concatenation set Code 128 security level to Level 2.

For Autodiscriminate ISBT Concatenation to operate as expected, both ISBT barcodes must be in the field of view at the same time. This may be difficult to achieve in presentation mode.

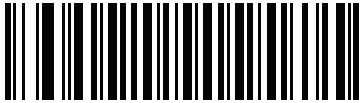

***Enable ISBT Concatenation
(1)
(default for HC models)**

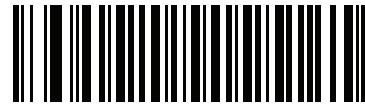

***Disable ISBT Concatenation
(0)
(default for SR/DL models)**



**Autodiscriminate ISBT Concatenation
(2)**

Check ISBT Table

Parameter # 578

SSI # F1h 42h

The ISBT specification includes a table that lists several types of ISBT bar codes that are commonly used in pairs. If you set **ISBT Concatenation** to **Enable**, enable **Check ISBT Table** to concatenate only those pairs found in this table. Other types of ISBT codes are not concatenated.



*Enable Check ISBT Table
(1)

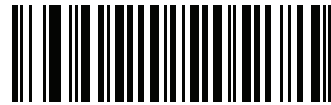

Disable Check ISBT Table
(0)

ISBT Concatenation Redundancy

Parameter # 223

SSI # DFh

If you set **ISBT Concatenation** to **Autodiscriminate**, use this parameter to set the number of times the scanner must decode an ISBT symbol before determining that there is no additional symbol.

Scan the following bar code, and then scan bar codes in [Appendix B, Numeric Bar Codes](#) to set a value between 2 and 20. Enter a leading zero for single digit numbers. To correct an error or change a selection, scan [Cancel on page B-3](#). The default is 10.



ISBT Concatenation Redundancy

Code 128 <FNC4>

Parameter # 1254

SSI # F8h 04h E6h

This feature applies to Code 128 bar codes with an embedded <FNC4> character. Select **Ignore Code 128 <FNC4>** to strip the <FNC4> character from the decode data. The remaining characters are sent to the host unchanged. When disabled, the <FNC4> character is processed normally as per Code 128 standard.

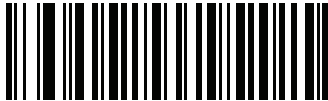

*Honor Code 128 <FNC4>
(0)



Ignore Code 128 <FNC4>
(1)

Code 128 Security Level

Parameter # 751

SSI # F1h EFh

Code 128 bar codes are vulnerable to misdecodes, particularly when Code 128 Lengths is set to **Any Length**. The scanner offers four levels of decode security for Code 128 bar codes. There is an inverse relationship between security and scanner aggressiveness. Increasing the level of security can reduce scanning aggressiveness, so select only the level of security necessary.

- **Code 128 Security Level 0** - The scanner operates in its most aggressive state, while providing sufficient security in decoding most in-spec bar codes.
- **Code 128 Security Level 1** - This option eliminates most misdecodes while maintaining reasonable aggressiveness.
- **Code 128 Security Level 2** - This option applies greater bar code security requirements if **Security Level 1** fails to eliminate misdecodes.
- **Code 128 Security Level 3** - If you selected **Security Level 2**, and misdecodes still occur, select this security level to apply the highest safety requirements.

✓ **NOTE** Selecting this option is an extreme measure against mis-decoding severely out-of-spec bar codes, and significantly impairs the decoding ability of the scanner. If this level of security is required, try to improve the quality of the bar codes.

Code 128 Security Level (continued)



Code 128 Security Level 0
(0)



*Code 128 Security Level 1
(1)



Code 128 Security Level 2
(2)



Code 128 Security Level 3
(3)

Code 128 Reduced Quiet Zone

Parameter # 1208

SSI # F8h 04h B8h

Scan one of the following bar codes to enable or disable decoding Code 128 bar codes with reduced quiet zones (the margins on either side of the bar code). If you select **Enable**, select a *1D Quiet Zone Level* on page 12-84.



Enable Code 128 Reduced Quiet Zone
(1)



*Disable Code 128 Reduced Quiet Zone
(0)

Code 39

Parameter # 0

SSI # 00h

Scan one of the following bar codes to enable or disable Code 39.

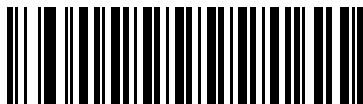

***Enable Code 39
(1)**

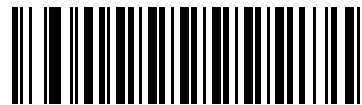

**Disable Code 39
(0)**

Trioptic Code 39

Parameter # 13

SSI # 0Dh

Trioptic Code 39 is a variant of Code 39 used in the marking of computer tape cartridges. Trioptic Code 39 symbols always contain six characters. Scan one of the following bar codes to enable or disable Trioptic Code 39.



**Enable Trioptic Code 39
(1)**



***Disable Trioptic Code 39
(0)**



NOTE You cannot enable Trioptic Code 39 and Code 39 Full ASCII simultaneously.

Convert Code 39 to Code 32

Parameter # 86

SSI # 56h

Code 32 is a variant of Code 39 used by the Italian pharmaceutical industry. Scan one of the following bar codes to enable or disable converting Code 39 to Code 32.

✓ **NOTE** Code 39 must be enabled for this parameter to function.

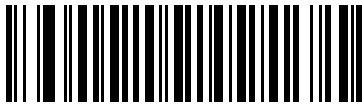

Enable Convert Code 39 to Code 32
(1)

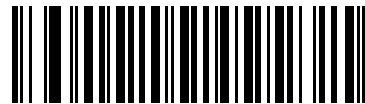

*Disable Convert Code 39 to Code 32
(0)

Code 32 Prefix

Parameter # 231

SSI # E7h

Scan one of the following bar codes to enable or disable adding the prefix character "A" to all Code 32 bar codes.

✓ **NOTE** Convert Code 39 to Code 32 must be enabled for this parameter to function.

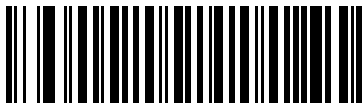

Enable Code 32 Prefix
(1)



*Disable Code 32 Prefix
(0)

Set Lengths for Code 39

L1 = Parameter # 18

SSI # 12h

L2 = Parameter # 19

SSI # 13h

The length of a code refers to the number of characters (i.e., human readable characters), including check digit(s) the code contains. Set lengths for Code 128 to any length, one or two discrete lengths, or lengths within a specific range. If Code 39 Full ASCII is enabled, **Length Within Range** or **Any Length** are the preferred options. The default is **Length Within Range**: 1 to 55.



NOTE When setting lengths, enter a leading zero for single digit numbers.

Scan one of the following bar codes to select a length option:

- **One Discrete Length** - Decode only Code 39 symbols containing a selected length. Select the length using the bar codes in [Appendix B, Numeric Bar Codes](#). For example, to decode only Code 39 symbols with 14 characters, scan **Code 39 - One Discrete Length**, and then scan **1, 4**. To correct an error or change the selection, scan [Cancel on page B-3](#).
- **Two Discrete Lengths** - Decode only Code 39 symbols containing either of two lengths. Select lengths using the bar codes in [Appendix B, Numeric Bar Codes](#). For example, to decode only Code 39 symbols containing either 2 or 14 characters, scan **Code 39 - Two Discrete Lengths**, and then scan **0, 2, 1, 4**. To correct an error or change the selection, scan [Cancel on page B-3](#).
- **Length Within Range** - Decode Code 39 symbols with a specific length range. Select lengths using the bar codes in [Appendix B, Numeric Bar Codes](#). For example, to decode Code 39 symbols containing between 4 and 12 characters, scan **Code 39 - Length Within Range**, and then scan **0, 4, 1, 2**. To correct an error or change the selection, scan [Cancel on page B-3](#).
- **Any Length** - Decode Code 39 symbols containing any number of characters within the scanner's capability.

Set Lengths for Code 39 (continued)



Code 39 - One Discrete Length



Code 39 - Two Discrete Lengths



*Code 39 - Length Within Range



Code 39 - Any Length

Code 39 Check Digit Verification

Parameter # 48

SSI # 30h

Scan **Enable Code 39 Check Digit** to check the integrity of all Code 39 symbols to verify that the data complies with specified check digit algorithm. Only Code 39 symbols which include a modulo 43 check digit are decoded. Enable this feature if the Code 39 symbols contain a Modulo 43 check digit.



Enable Code 39 Check Digit
(1)

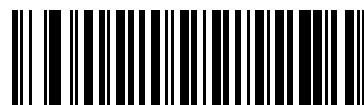

*Disable Code 39 Check Digit
(0)

Transmit Code 39 Check Digit

Parameter # 43

SSI # 2Bh

Scan one of the following bar codes to transmit Code 39 data with or without the check digit.

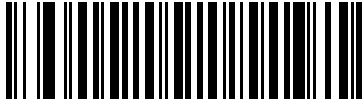

Transmit Code 39 Check Digit (Enable)
(1)



*Do Not Transmit Code 39 Check Digit (Disable)
(0)



NOTE *Code 39 Check Digit Verification* must be enabled for this parameter to function.

Code 39 Full ASCII Conversion

Parameter # 17

SSI # 11h

Code 39 Full ASCII is a variant of Code 39 which pairs characters to encode the full ASCII character set. Scan one of the following bar codes to enable or disable Code 39 Full ASCII.

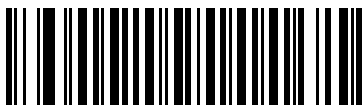

Enable Code 39 Full ASCII
(1)



*Disable Code 39 Full ASCII
(0)



NOTE You cannot enable Trioptic Code 39 and Code 39 Full ASCII simultaneously.

Code 39 Full ASCII to Full ASCII Correlation is host-dependent, and is therefore described in the ASCII character set table for the appropriate interface. See [Table D-1 on page D-1](#).

Code 39 Security Level

Parameter # 750

SSI # F1h EEh

The scanner offers four levels of decode security for Code 39 bar codes. There is an inverse relationship between security and scanner aggressiveness. Increasing the level of security can reduce scanning aggressiveness, so select only the level of security necessary.

- **Code 39 Security Level 0:** The scanner operates in its most aggressive state, while providing sufficient security in decoding most in-spec bar codes.
- **Code 39 Security Level 1:** This default setting eliminates most misdecodes.
- **Code 39 Security Level 2:** This option applies greater bar code security requirements if **Security Level 1** fails to eliminate misdecodes.
- **Code 39 Level 3:** If you selected **Security Level 2**, and misdecodes still occur, select this security level to apply the highest safety requirements.

✓ **NOTE** Selecting this option is an extreme measure against mis-decoding severely out-of-spec bar codes, and significantly impairs the decoding ability of the scanner. If this level of security is required, try to improve the quality of the bar codes.

Code 39 Security Level (continued)



**Code 39 Security Level 0
(0)**



***Code 39 Security Level 1
(1)**



**Code 39 Security Level 2
(2)**



**Code 39 Security Level 3
(3)**

Code 39 Reduced Quiet Zone

Parameter # 1209

SSI # F8h 04h B9h

Scan one of the following bar codes to enable or disable decoding Code 39 bar codes with reduced quiet zones (the margins on either side of the bar code). If you select **Enable**, select a *1D Quiet Zone Level* on page 12-84.



Enable Code 39 Reduced Quiet Zone
(1)

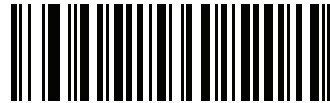

*Disable Code 39 Reduced Quiet Zone
(0)

Code 93

Parameter # 9

SSI # 09h

Scan one of the following bar codes to enable or disable Code 93.

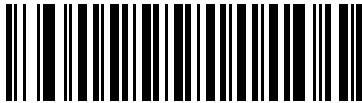

***Enable Code 93**
(1)



Disable Code 93
(0)

Set Lengths for Code 93

L1 = Parameter # 26

SSI # 1Ah

L2 = Parameter # 27

SSI # 1Bh

The length of a code refers to the number of characters (i.e., human readable characters), including check digit(s) the code contains. Set lengths for Code 93 to any length, one or two discrete lengths, or lengths within a specific range. The default is **Length Within Range: 1 to 55**.



NOTE When setting lengths, enter a leading zero for single digit numbers.

Scan one of the following bar codes to select a length option:

- **One Discrete Length** - Decode only Code 93 symbols containing a selected length. Select the length using the bar codes in [Appendix B, Numeric Bar Codes](#). For example, to decode only Code 93 symbols with 14 characters, scan **Code 93 - One Discrete Length**, and then scan **1, 4**. To correct an error or change the selection, scan [Cancel on page B-3](#).
- **Two Discrete Lengths** - Decode only Code 93 symbols containing either of two lengths. Select lengths using the bar codes in [Appendix B, Numeric Bar Codes](#). For example, to decode only Code 93 symbols containing either 2 or 14 characters, scan **Code 93 - Two Discrete Lengths**, and then scan **0, 2, 1, 4**. To correct an error or change the selection, scan [Cancel on page B-3](#).
- **Length Within Range** - Decode Code 93 symbols with a specific length range. Select lengths using the bar codes in [Appendix B, Numeric Bar Codes](#). For example, to decode Code 93 symbols containing between 4 and 12 characters, scan **Code 93 - Length Within Range**, and then scan **0, 4, 1, 2**. To correct an error or change the selection, scan [Cancel on page B-3](#).
- **Any Length** - Decode Code 93 symbols containing any number of characters within the scanner's capability.

Set Lengths for Code 93 (continued)



Code 93 - One Discrete Length



Code 93 - Two Discrete Lengths



***Code 93 - Length Within Range**



Code 93 - Any Length

Code 11

Parameter # 10

SSI # 0Ah

Scan one of the following bar codes to enable or disable Code 11

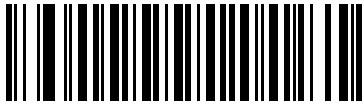

Enable Code 11
(1)

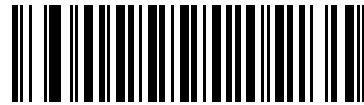

*Disable Code 11
(0)

Set Lengths for Code 11

L1 = Parameter # 28

SSI # 1Ch

L2 = Parameter # 29

SSI # 1Dh

The length of a code refers to the number of characters (i.e., human readable characters), including check digit(s) the code contains. Set lengths for Code 11 to any length, one or two discrete lengths, or lengths within a specific range. The default is **Length Within Range: 4 to 55**.



NOTE When setting lengths, enter a leading zero for single digit numbers.

Scan one of the following bar codes to select a length option:

- **One Discrete Length** - Decode only Code 11 symbols containing a selected length. Select the length using the bar codes in [Appendix B, Numeric Bar Codes](#). For example, to decode only Code 11 symbols with 14 characters, scan **Code 11 - One Discrete Length**, and then scan **1, 4**. To correct an error or change the selection, scan [Cancel on page B-3](#).
- **Two Discrete Lengths** - Decode only Code 11 symbols containing either of two lengths. Select lengths using the bar codes in [Appendix B, Numeric Bar Codes](#). For example, to decode only Code 11 symbols containing either 2 or 14 characters, scan **Code 11 - Two Discrete Lengths**, and then scan **0, 2, 1, 4**. To correct an error or change the selection, scan [Cancel on page B-3](#).
- **Length Within Range** - Decode Code 11 symbols with a specific length range. Select lengths using the bar codes in [Appendix B, Numeric Bar Codes](#). For example, to decode Code 11 symbols containing between 4 and 12 characters, scan **Code 11 - Length Within Range**, and then scan **0, 4, 1, 2**. To correct an error or change the selection, scan [Cancel on page B-3](#).
- **Any Length** - Decode Code 11 symbols containing any number of characters within the scanner's capability.

Set Lengths for Code 11 (continued)



Code 11 - One Discrete Length



Code 11 - Two Discrete Lengths



***Code 11 - Length Within Range**



Code 11 - Any Length

Code 11 Check Digit Verification

Parameter # 52

SSI # 34h

This feature allows the scanner to check the integrity of all Code 11 symbols to verify that the data complies with the specified check digit algorithm.

Scan one of the following bar codes to specify the number of check digits encoded in the Code 11 symbols, or to disable this feature.

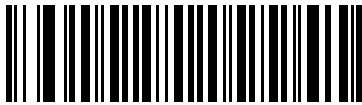

***Disable
(0)**

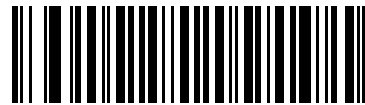

**One Check Digit
(1)**

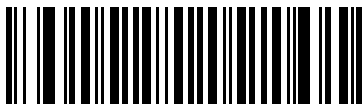

**Two Check Digits
(2)**

Transmit Code 11 Check Digits

Parameter # 47

SSI # 2Fh

Scan one of the following bar codes to select whether or not to transmit the Code 11 check digit(s).

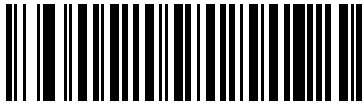

Transmit Code 11 Check Digit(s) (Enable)
(1)

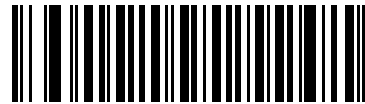

*Do Not Transmit Code 11 Check Digit(s) (Disable)
(0)



NOTE *Code 11 Check Digit Verification* must be enabled for this parameter to function.

Interleaved 2 of 5 (ITF)

Parameter # 6

SSI # 06h

Scan one of the following bar codes to enable or disable Interleaved 2 of 5.

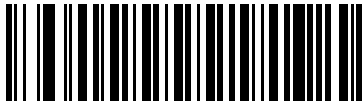

***Enable Interleaved 2 of 5
(1)**

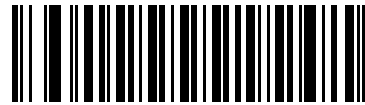

**Disable Interleaved 2 of 5
(0)**

Set Lengths for Interleaved 2 of 5

L1 = Parameter # 22

SSI # 16h

L2 = Parameter # 23

SSI # 17h

The length of a code refers to the number of characters (i.e., human readable characters), including check digit(s) the code contains. Set lengths for I 2 of 5 to any length, one or two discrete lengths, or lengths within a specific range. The range for Interleaved 2 of 5 lengths is 0 - 80. The default is **Length Within Range**: 6 to 55.



NOTE When setting lengths, enter a leading zero for single digit numbers.

Scan one of the following bar codes to select a length option:

- **One Discrete Length** - Decode only I 2 of 5 symbols containing a selected length. Select the length using the bar codes in [Appendix B, Numeric Bar Codes](#). For example, to decode only I 2 of 5 symbols with 14 characters, scan **I 2 of 5 - One Discrete Length**, and then scan **1, 4**. To correct an error or change the selection, scan [Cancel on page B-3](#).
- **Two Discrete Lengths** - Decode only I 2 of 5 symbols containing either of two lengths. Select lengths using the bar codes in [Appendix B, Numeric Bar Codes](#). For example, to decode only I 2 of 5 symbols containing either 2 or 14 characters, scan **I 2 of 5 - Two Discrete Lengths**, and then scan **0, 2, 1, 4**. To correct an error or change the selection, scan [Cancel on page B-3](#).
- **Length Within Range** - Decode I 2 of 5 symbols with a specific length range. Select lengths using the bar codes in [Appendix B, Numeric Bar Codes](#). For example, to decode I 2 of 5 symbols containing between 4 and 12 characters, scan **I 2 of 5 - Length Within Range**, and then scan **0, 4, 1, 2**. To correct an error or change the selection, scan [Cancel on page B-3](#).

Set Lengths for Interleaved 2 of 5 (continued)

- **Any Length** - Decode I 2 of 5 symbols containing any number of characters within the scanner's capability.

✓ **NOTE** Due to the construction of the I 2 of 5 symbology, it is possible for a scan line covering only a portion of the code to transmit as a complete scan, yielding less data than is encoded in the bar code. To prevent this, select specific lengths (I 2 of 5 - One Discrete Length, Two Discrete Lengths) for I 2 of 5 applications, or increase the *I 2 of 5 Security Level* on page 12-56.



I 2 of 5 - One Discrete Length



I 2 of 5 - Two Discrete Lengths



***I 2 of 5 - Length Within Range**



I 2 of 5 - Any Length

I 2 of 5 Check Digit Verification

Parameter # 49

SSI # 31h

Scan one of the following bar codes to check the integrity of all I 2 of 5 symbols to verify the data complies with either the specified Uniform Symbology Specification (USS), or the Optical Product Code Council (OPCC) check digit algorithm.



***Disable
(0)**



**USS Check Digit
(1)**



**OPCC Check Digit
(2)**

Transmit I 2 of 5 Check Digit

Parameter # 44
SSI # 2Ch

Scan one of the following bar codes to transmit I 2 of 5 data with or without the check digit.

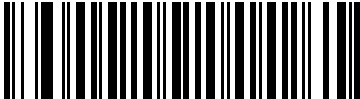

Transmit I 2 of 5 Check Digit (Enable)
(1)



*Do Not Transmit I 2 of 5 Check Digit (Disable)
(0)

Convert I 2 of 5 to EAN-13

Parameter # 82
SSI # 52h

Scan **Convert I 2 of 5 to EAN-13 (Enable)** to convert 14-character I 2 of 5 codes to EAN-13, and transmit to the host as EAN-13. To accomplish this, the I 2 of 5 code must be enabled, and the code must have a leading zero and a valid EAN-13 check digit.

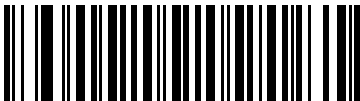

Convert I 2 of 5 to EAN-13 (Enable)
(1)



*Do Not Convert I 2 of 5 to EAN-13 (Disable)
(0)

I 2 of 5 Security Level

Parameter # 1121

SSI # F8h 04h 61h

Interleaved 2 of 5 bar codes are vulnerable to misdecodes, particularly when I 2 of 5 Lengths is set to **Any Length**. The scanner offers four levels of decode security for Interleaved 2 of 5 bar codes. There is an inverse relationship between security and scanner aggressiveness. Increasing the level of security can reduce scanning aggressiveness, so select only the level of security necessary.

- **I 2 of 5 Security Level 0:** The scanner operates in its most aggressive state, while providing sufficient security in decoding most in-spec bar codes.
- **I 2 of 5 Security Level 1:** A bar code must be successfully read twice, and satisfy certain safety requirements before being decoded. This default setting eliminates most misdecodes.
- **I 2 of 5 Security Level 2:** This option applies greater bar code security requirements if **Security Level 1** fails to eliminate misdecodes.
- **I 2 of 5 Security Level 3:** If you selected **Security Level 2**, and misdecodes still occur, select this security level. The highest safety requirements are applied. A bar code must be successfully read three times before being decoded.

✓ **NOTE** Selecting this option is an extreme measure against mis-decoding severely out-of-spec bar codes, and significantly impairs the decoding ability of the scanner. If this level of security is required, try to improve the quality of the bar codes.



I 2 of 5 Security Level 0
(0)

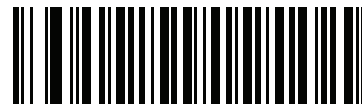

*I 2 of 5 Security Level 1
(1)

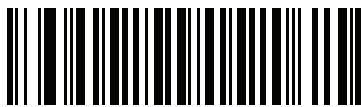

I 2 of 5 Security Level 2
(2)



I 2 of 5 Security Level 3
(3)

I 2 of 5 Reduced Quiet Zone

Parameter # 1210

SSI # F8h 04h BAh

Scan one of the following bar codes to enable or disable decoding I 2 of 5 bar codes with reduced quiet zones (the margins on either side of the bar code). If you select **Enable**, select a *1D Quiet Zone Level* on page 12-84.

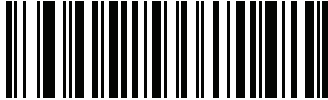

Enable I 2 of 5 Reduced Quiet Zone
(1)



*Disable I 2 of 5 Reduced Quiet Zone
(0)

Discrete 2 of 5 (DTF)

Parameter # 5

SSI # 05h

Scan one of the following bar codes to enable or disable Discrete 2 of 5.

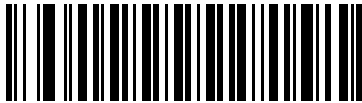

Enable Discrete 2 of 5
(1)



*Disable Discrete 2 of 5
(0)

Set Lengths for Discrete 2 of 5

L1 = Parameter # 20

SSI # 14h

L2 = Parameter # 21

SSI # 15h

The length of a code refers to the number of characters (i.e., human readable characters), including check digit(s) the code contains. Set lengths for D 2 of 5 to any length, one or two discrete lengths, or lengths within a specific range. The default is **Length Within Range: 1 to 55**.



NOTE When setting lengths, enter a leading zero for single digit numbers.

Scan one of the following bar codes to select a length option:

- **One Discrete Length** - Decode only D 2 of 5 symbols containing a selected length. Select the length using the bar codes in [Appendix B, Numeric Bar Codes](#). For example, to decode only D 2 of 5 symbols with 14 characters, scan **D 2 of 5 - One Discrete Length**, and then scan **1, 4**. To correct an error or change the selection, scan [Cancel on page B-3](#).
- **Two Discrete Lengths** - Decode only D 2 of 5 symbols containing either of two lengths. Select lengths using the bar codes in [Appendix B, Numeric Bar Codes](#). For example, to decode only D 2 of 5 symbols containing either 2 or 14 characters, scan **D 2 of 5 - Two Discrete Lengths**, and then scan **0, 2, 1, 4**. To correct an error or change the selection, scan [Cancel on page B-3](#).
- **Length Within Range** - Decode D 2 of 5 symbols with a specific length range. Select lengths using the bar codes in [Appendix B, Numeric Bar Codes](#). For example, to decode D 2 of 5 symbols containing between 4 and 12 characters, scan **D 2 of 5 - Length Within Range**, and then scan **0, 4, 1, 2**. To correct an error or change the selection, scan [Cancel on page B-3](#).

Set Lengths for Discrete 2 of 5 (continued)

- **Any Length** - Decode D 2 of 5 symbols containing any number of characters within the scanner's capability.

✓ **NOTE** Due to the construction of the D 2 of 5 symbology, it is possible for a scan line covering only a portion of the code to transmit as a complete scan, yielding less data than is encoded in the bar code. To prevent this, select specific lengths (D 2 of 5 - One Discrete Length, Two Discrete Lengths) for D 2 of 5 applications.



D 2 of 5 - One Discrete Length



D 2 of 5 - Two Discrete Lengths



***D 2 of 5 - Length Within Range**



D 2 of 5 - Any Length

Codabar (NW - 7)

Parameter # 7

SSI # 07h

Scan one of the following bar codes to enable or disable Codabar.

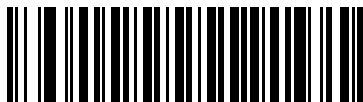

*Enable Codabar
(1)

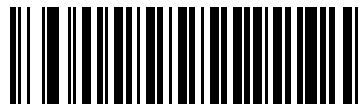

Disable Codabar
(0)

Set Lengths for Codabar

L1 = Parameter # 24

SSI # 18h

L2 = Parameter # 25

SSI # 19h

The length of a code refers to the number of characters (i.e., human readable characters), including check digit(s) the code contains. Set lengths for Codabar to any length, one or two discrete lengths, or lengths within a specific range. The default is **Length Within Range: 4 to 55**.

✓ **NOTE** When setting lengths, enter a leading zero for single digit numbers.

Scan one of the following bar codes to select a length option:

- **One Discrete Length** - Decode only Codabar symbols containing a selected length. Select the length using the bar codes in [Appendix B, Numeric Bar Codes](#). For example, to decode only Codabar symbols with 14 characters, scan **Codabar - One Discrete Length**, and then scan **1, 4**. To correct an error or change the selection, scan [Cancel on page B-3](#).
- **Two Discrete Lengths** - Decode only Codabar symbols containing either of two lengths. Select lengths using the bar codes in [Appendix B, Numeric Bar Codes](#). For example, to decode only Codabar symbols containing either 2 or 14 characters, scan **Codabar - Two Discrete Lengths**, and then scan **0, 2, 1, 4**. To correct an error or change the selection, scan [Cancel on page B-3](#).
- **Length Within Range** - Decode Codabar symbols with a specific length range. Select lengths using the bar codes in [Appendix B, Numeric Bar Codes](#). For example, to decode Codabar symbols containing between 4 and 12 characters, scan **Codabar - Length Within Range**, and then scan **0, 4, 1, 2**. To correct an error or change the selection, scan [Cancel on page B-3](#).
- **Any Length** - Decode Codabar symbols containing any number of characters within the scanner's capability.

Set Lengths for Codabar (continued)



Codabar - One Discrete Length

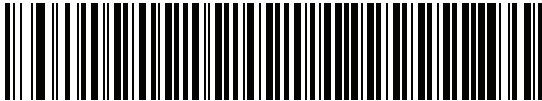

Codabar - Two Discrete Lengths



***Codabar - Length Within Range**



Codabar - Any Length

CLSI Editing

Parameter # 54

SSI # 36h

Scan **Enable CLSI Editing** to strip the start and stop characters and insert a space after the first, fifth, and tenth characters of a 14-character Codabar symbol if the host system requires this data format.

✓ **NOTE** Symbol length does not include start and stop characters.



Enable CLSI Editing
(1)

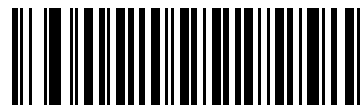

*Disable CLSI Editing
(0)

NOTIS Editing

Parameter # 55

SSI # 37h

Scan **Enable NOTIS Editing** to strip the start and stop characters from a decoded Codabar symbol if the host system requires this data format.

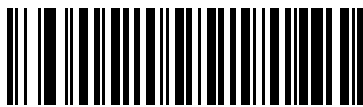

Enable NOTIS Editing
(1)

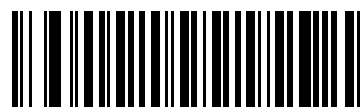

*Disable NOTIS Editing
(0)

Codabar Security Level

Parameter # 1776

SSI # F8h 06h F0h

The digital scanner offers four levels of decode security for Codabar bar codes. There is an inverse relationship between security and digital scanner aggressiveness. Increasing the level of security can reduce scanning aggressiveness, so select only the level of security necessary.

- **Codabar Security Level 0:** This setting allows the digital scanner to operate in its most aggressive state, while providing sufficient security in decoding most in-spec bar codes.
- **Codabar Security Level 1:** This default setting eliminates most misdecodes.
- **Codabar Security Level 2:** Select this option with greater bar code security requirements if **Security Level 1** fails to eliminate misdecodes.
- **Codabar Security Level 3:** If you selected **Security Level 2**, and misdecodes still occur, select this security level to apply the highest safety requirements.

✓ **NOTE** Selecting this option is an extreme measure against mis-decoding severely out-of-spec bar codes, and significantly impairs the decoding ability of the digital scanner. If this level of security is required, try to improve the quality of the bar codes.



Codabar Security Level 0
(0)

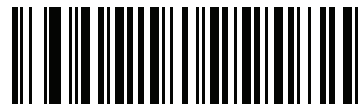

*Codabar Security Level 1
(1)



Codabar Security Level 2
(2)



Codabar Security Level 3
(3)

Codabar Upper or Lower Case Start/Stop Characters

Parameter # 855

SSI # F2h 57h

Scan one of the following bar codes to select whether to transmit upper case or lower case Codabar start/stop characters.



Lower Case
(1)



*Upper Case
(0)

MSI

Parameter # 11

SSI # 0Bh

Scan one of the following bar codes to enable or disable MSI.

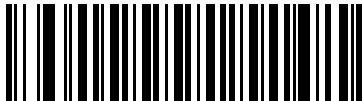

Enable MSI
(1)

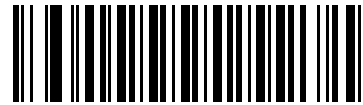

*Disable MSI
(0)

Set Lengths for MSI

L1 = Parameter # 30

SSI # 1Eh

L2 = Parameter # 31

SSI # 1Fh

The length of a code refers to the number of characters (i.e., human readable characters), including check digit(s) the code contains. Set lengths for MSI to any length, one or two discrete lengths, or lengths within a specific range. The default is **Length Within Range: 4 to 55**.

✓ **NOTE** When setting lengths, enter a leading zero for single digit numbers.

Scan one of the following bar codes to select a length option:

- **One Discrete Length** - Decode only MSI symbols containing a selected length. Select the length using the bar codes in [Appendix B, Numeric Bar Codes](#). For example, to decode only MSI symbols with 14 characters, scan **MSI - One Discrete Length**, and then scan **1, 4**. To correct an error or change the selection, scan [Cancel on page B-3](#).
- **Two Discrete Lengths** - Decode only MSI symbols containing either of two lengths. Select lengths using the bar codes in [Appendix B, Numeric Bar Codes](#). For example, to decode only MSI symbols containing either 2 or 14 characters, scan **MSI - Two Discrete Lengths**, and then scan **0, 2, 1, 4**. To correct an error or change the selection, scan [Cancel on page B-3](#).
- **Length Within Range** - Decode MSI symbols with a specific length range. Select lengths using the bar codes in [Appendix B, Numeric Bar Codes](#). For example, to decode MSI symbols containing between 4 and 12 characters, scan **MSI - Length Within Range**, and then scan **0, 4, 1, 2**. To correct an error or change the selection, scan [Cancel on page B-3](#).

Set Lengths for MSI (continued)

- **Any Length** - Decode MSI symbols containing any number of characters within the scanner's capability.



NOTE Due to the construction of the MSI symbology, it is possible for a scan line covering only a portion of the code to transmit as a complete scan, yielding less data than is encoded in the bar code. To prevent this, select specific lengths (**MSI - One Discrete Length, Two Discrete Lengths**) for MSI applications.

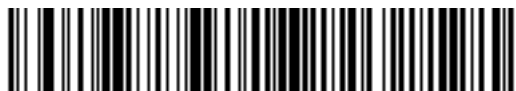

MSI - One Discrete Length



MSI - Two Discrete Lengths



***MSI - Length Within Range**



MSI - Any Length

MSI Check Digits

Parameter # 50

SSI # 32h

With MSI symbols, one check digit is mandatory and always verified by the reader. The second check digit is optional. If the MSI codes include two check digits, scan the **Two MSI Check Digits** barcode to enable verification of the second check digit.

- 0 - Does not check the MSI check digit; decodes MSI with no check digit.
- 1 - This is for MSI barcodes with one check digit. This is the default.
- 2 - This is for MSI barcodes with two check digits.

See [MSI Check Digit Algorithm on page 12-69](#) to select second digit algorithms.

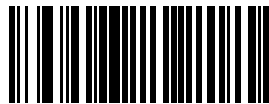

No MSI Check Digit
(0)

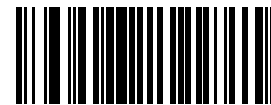

*One MSI Check Digit
(1)

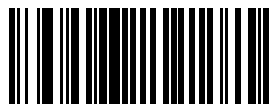

Two MSI Check Digits
(2)

Transmit MSI Check Digit(s)

Parameter # 46

SSI # 2Eh

Scan one of the following bar codes to transmit MSI data with or without the check digit.

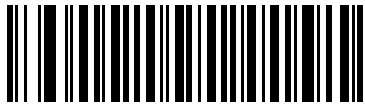

Transmit MSI Check Digit(s) (Enable)
(1)

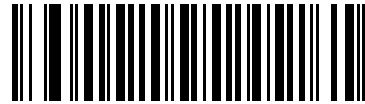

***Do Not Transmit MSI Check Digit(s) (Disable)**
(0)

MSI Check Digit Algorithm

Parameter # 51

SSI # 33h

Two algorithms are available for verifying the second MSI check digit. Scan one of the following bar codes to select the algorithm used to encode the check digit.



MOD 11/MOD 10
(0)

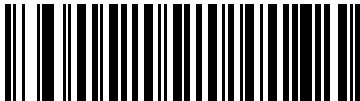

*MOD 10/MOD 10
(1)

MSI Reduced Quiet Zone

Parameter # 1392

SSI # F8h 05h 70h

Scan one of the following bar codes to enable or disable decoding MSI bar codes with reduced quiet zones. If you select **Enable**, select a *1D Quiet Zone Level* on page 12-84.



*Disable MSI Reduced Quiet Zone
(0)



Enable MSI Reduced Quiet Zone
(1)

Chinese 2 of 5

Parameter # 408

SSI # F0h 98h

Scan one of the following bar codes to enable or disable Chinese 2 of 5.



**Enable Chinese 2 of 5
(1)**

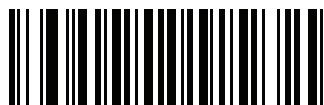

***Disable Chinese 2 of 5
(0)**

Matrix 2 of 5

Parameter # 618

SSI # F1h 6Ah

Scan one of the following bar codes to enable or disable Matrix 2 of 5.



Enable Matrix 2 of 5
(1)



***Disable Matrix 2 of 5**
(0)

Set Lengths for Matrix 2 of 5

L1 = Parameter # 619

SSI # F1h 6Bh

L2 = Parameter # 620

SSI # F1h 6Ch

The length of a code refers to the number of characters (i.e., human readable characters), including check digit(s) the code contains. Set lengths for Matrix 2 of 5 to any length, one or two discrete lengths, or lengths within a specific range. The default is **Length Within Range: 4 to 55**.

✓ **NOTE** When setting lengths, enter a leading zero for single digit numbers.

Scan one of the following bar codes to select a length option:

- **One Discrete Length** - Decode only Matrix 2 of 5 symbols containing a selected length. Select the length using the bar codes in [Appendix B, Numeric Bar Codes](#). For example, to decode only Matrix 2 of 5 symbols with 14 characters, scan **Matrix 2 of 5 - One Discrete Length**, and then scan **1, 4**. To correct an error or change the selection, scan [Cancel on page B-3](#).
- **Two Discrete Lengths** - Decode only Matrix 2 of 5 symbols containing either of two lengths. Select lengths using the bar codes in [Appendix B, Numeric Bar Codes](#). For example, to decode only Matrix 2 of 5 symbols containing either 2 or 14 characters, scan **Matrix 2 of 5 - Two Discrete Lengths**, and then scan **0, 2, 1, 4**. To correct an error or change the selection, scan [Cancel on page B-3](#).
- **Length Within Range** - Decode Matrix 2 of 5 symbols with a specific length range. Select lengths using the bar codes in [Appendix B, Numeric Bar Codes](#). For example, to decode Matrix 2 of 5 symbols containing between 4 and 12 characters, scan **Matrix 2 of 5 - Length Within Range**, and then scan **0, 4, 1, 2**. To correct an error or change the selection, scan [Cancel on page B-3](#).

Set Lengths for Matrix 2 of 5 (continued)

- **Any Length** - Decode Matrix 2 of 5 symbols containing any number of characters within the scanner's capability.



Matrix 2 of 5 - One Discrete Length



Matrix 2 of 5 - Two Discrete Lengths



***Matrix 2 of 5 - Length Within Range**



Matrix 2 of 5 - Any Length

Matrix 2 of 5 Check Digit

Parameter # 622

SSI # F1h 6Eh

The check digit is the last character of the symbol used to verify the integrity of the data. Scan one of the following bar codes to determine whether to include the Matrix 2 of 5 check digit with the bar code data.



Enable Matrix 2 of 5 Check Digit
(1)

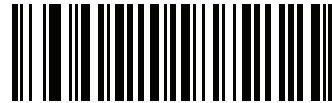

*Disable Matrix 2 of 5 Check Digit
(0)

Transmit Matrix 2 of 5 Check Digit

Parameter # 623

SSI # F1h 6Fh

Scan one of the following bar codes to transmit Matrix 2 of 5 data with or without the check digit.



Transmit Matrix 2 of 5 Check Digit
(1)



*Do Not Transmit Matrix 2 of 5 Check Digit
(0)

Korean 3 of 5

Parameter # 581

SSI # F1h 45h

Scan one of the following bar codes to enable or disable Korean 3 of 5.

✓ **NOTE** The length for Korean 3 of 5 is fixed at 6.

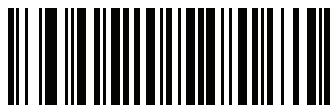

Enable Korean 3 of 5
(1)



***Disable Korean 3 of 5**
(0)

Inverse 1D

Parameter # 586

SSI # F1h 4Ah

Scan one of the following bar codes to set the 1D inverse decoder setting:

- **Regular Only** - The scanner decodes regular 1D bar codes only.
- **Inverse Only** - The scanner decodes inverse 1D bar codes only.
- **Inverse Autodetect** - The scanner decodes both regular and inverse 1D bar codes.

✓ **NOTE** The Inverse 1D setting may impact Composite or Inverse Composite decoding. See *Composite Inverse* on page 12-87.



***Regular
(0)**



**Inverse Only
(1)**



**Inverse Autodetect
(2)**

GS1 DataBar

The variants of GS1 DataBar are GS1 DataBar Omnidirectional, GS1 DataBar Truncated, GS1 DataBar Stacked, GS1 DataBar Stacked Omnidirectional, DataBar Expanded, GS1 DataBar Expanded Stacked and DataBar Limited. The limited and expanded versions have stacked variants. Scan the appropriate bar codes to enable or disable each variant of GS1 DataBar.

GS1 DataBar Omnidirectional (formerly GS1 DataBar-14), GS1 DataBar Truncated, GS1 DataBar Stacked, GS1 DataBar Stacked Omnidirectional

✓ **NOTE** When GS1 DataBar Omnidirectional is enabled the variants are also enabled.

Parameter # 338
SSI # F0h 52h

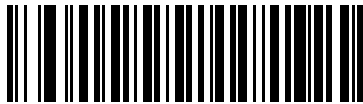

***Enable GS1 DataBar Omnidirectional**
(1)



Disable GS1 DataBar Omnidirectional
(0)

GS1 DataBar Limited

Parameter # 339
SSI # F0h 53h

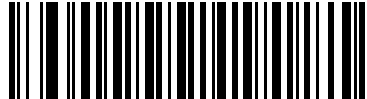

*Enable GS1 DataBar Limited
(1)



Disable GS1 DataBar Limited
(0)

GS1 DataBar Expanded, GS1 DataBar Expanded Stacked

✓ *NOTE* When GS1 DataBar Expanded is enabled GS1 DataBar Expanded Stacked is also enabled.

Parameter # 340
SSI # F0h 54h

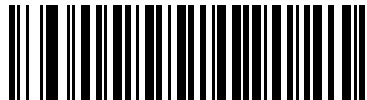

*Enable GS1 DataBar Expanded
(1)

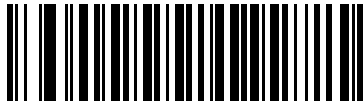

Disable GS1 DataBar Expanded
(0)

Convert GS1 DataBar to UPC/EAN/JAN

Parameter # 397

SSI # F0h, 8Dh

This parameter only applies to GS1 DataBar Omnidirectional and GS1 DataBar Limited symbols not decoded as part of a Composite symbol. Scan **Enable Convert GS1 DataBar to UPC/EAN/JAN** to strip the leading '010' from DataBar-14 and DataBar Limited symbols encoding a single zero as the first digit, and report the bar code as EAN-13.

For bar codes beginning with between two and five zeros, this strips the leading '0100' and reports the bar code as UPC-A. The *UPC-A Preamble* option that transmits the system character and country code applies to converted bar codes. Note that neither the system character nor the check digit can be stripped.

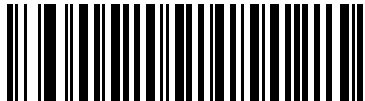

**Enable Convert GS1 DataBar to UPC/EAN/JAN
(1)**

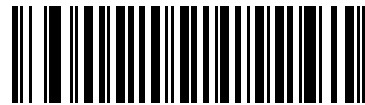

***Disable Convert GS1 DataBar to UPC/EAN/JAN
(0)**

GS1 DataBar Security Level

Parameter # 1706

SSI # F8h 06h AAh

The scanner offers four levels of decode security for GS1 DataBar (GS1 DataBar Omnidirectional, GS1 DataBar Limited, GS1 DataBar Expanded) bar codes.

- **Security Level 0** - The scanner operates in its most aggressive state, while providing sufficient security decoding most in-spec bar codes.
- **Security Level 1** - This setting eliminates most misdecodes while maintaining reasonable aggressiveness.
- **Security Level 2** - Select this option with greater bar code security requirements if Security Level 1 fails to eliminate misdecodes.
- **Security Level 3** - If you selected Security Level 2 and misdecodes still occur, select this security level to apply the highest safety requirements.



GS1 DataBar Security Level 0
(0)



***GS1 DataBar Security Level 1**
(1)



GS1 DataBar Security Level 2
(2)



GS1 DataBar Security Level 3
(3)

GS1 DataBar Limited Margin Check

Parameter # 728

SSI # F1h D8h

The scanner offers four levels of decode security for GS1 DataBar Limited bar codes. There is an inverse relationship between the level of margin check and scanner aggressiveness. Increasing the level of margin check can reduce scanning aggressiveness, so select only the level of margin check necessary.

- **Margin Check Level 1** – No clear margin required. This complies with the original GS1 standard, yet can result in erroneous decoding of a DataBar Limited bar code when scanning some UPC symbols that start with digits **9** and **7**.
- **Margin Check Level 2** – Automatic risk detection. This level of margin check can result in erroneous decoding of DataBar Limited bar codes when scanning some UPC symbols. If a misdecode is detected, the scanner operates in Level 3 or Level 1.
- **Margin Check Level 3** – Margin check level reflects the newly proposed GS1 standard that requires a five times trailing clear margin.
- **Margin Check Level 4** – Security level extends beyond the standard required by GS1. This level of margin check requires a five times leading and trailing clear margin.



GS1 DataBar Limited Margin Check Level 1
(1)



GS1 DataBar Limited Margin Check Level 2
(2)



*GS1 DataBar Limited Margin Check Level 3
(3)



GS1 DataBar Limited Margin Check Level 4
(4)

Symbology-Specific Security Features

Redundancy Level

Parameter # 78

SSI # 4Eh

The scanner offers four levels of decode redundancy. Select higher redundancy levels for decreasing levels of bar code quality. As redundancy levels increase, the scanner's aggressiveness decreases.

Scan one of the following bar codes to select the redundancy level appropriate for the bar code quality:

- **Redundancy Level 1** - The scanner must read the following code types twice before decoding:
 - Codabar (8 characters or less)
 - MSI (4 characters or less)
 - D 2 of 5 (8 characters or less)
 - I 2 of 5 (8 characters or less)
- **Redundancy Level 2** - The scanner must read all code types twice before decoding.
- **Redundancy Level 3** - The scanner must read code types other than the following twice before decoding, but must read the following codes three times:
 - Codabar (8 characters or less)
 - MSI (4 characters or less)
 - D 2 of 5 (8 characters or less)
 - I 2 of 5 (8 characters or less)
- **Redundancy Level 4** - The scanner must read all code types three times before decoding.

Redundancy Level (continued)



***Redundancy Level 1
(1)**

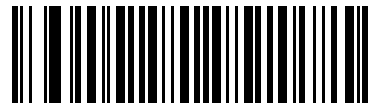

**Redundancy Level 2
(2)**

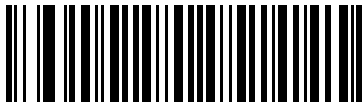

**Redundancy Level 3
(3)**

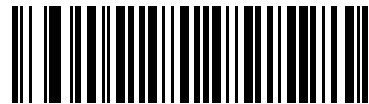

**Redundancy Level 4
(4)**

Security Level

Parameter # 77

SSI # 4Dh

The scanner offers four levels of decode security for delta bar codes, which include the Code 128 family, UPC/EAN/JAN, and Code 93. Select increasing levels of security for decreasing levels of bar code quality. There is an inverse relationship between security and scanner aggressiveness, so choose only that level of security necessary for the application.

- **Security Level 0** - The scanner operates in its most aggressive state, while providing sufficient security decoding most in-spec bar codes.
- **Security Level 1** - This default setting eliminates most misdecodes.
- **Security Level 2** - Select this option if Security Level 1 fails to eliminate misdecodes.
- **Security Level 3** - If you selected Security Level 2 and misdecodes still occur, select this security level.

✓ **NOTE** Selecting this option is an extreme measure against mis-decoding severely out-of-spec bar codes, and significantly impairs the decoding ability of the scanner. If this level of security is required, try to improve the quality of the bar codes.

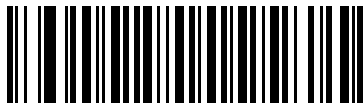

Security Level 0
(0)

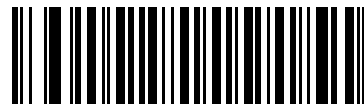

***Security Level 1**
(1)

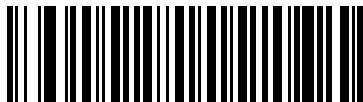

Security Level 2
(2)

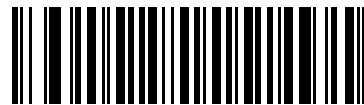

Security Level 3
(3)

1D Quiet Zone Level

Parameter # 1288

SSI # F8h 05h 08h

This feature sets the level of aggressiveness when decoding bar codes with a reduced quiet zone (the margin on either side of a bar code), and applies to symbologies enabled by a Reduced Quiet Zone parameter. Because higher levels increase the decoding time and risk of misdecodes, Zebra strongly recommends enabling only the symbologies which require higher quiet zone levels, and leaving Reduced Quiet Zone disabled for all other symbologies. Options are:

- **1D Quiet Zone Level 0** - The scanner performs normally in terms of quiet zone.
- **1D Quiet Zone Level 1** - The scanner performs more aggressively in terms of quiet zone.
- **1D Quiet Zone Level 2** - The scanner only requires a quiet zone at the end of bar code for decoding.
- **1D Quiet Zone Level 3** - The scanner decodes anything in terms of quiet zone or end of bar code.

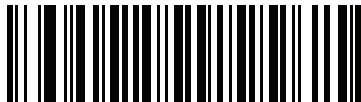

1D Quiet Zone Level 0
(0)

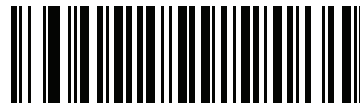

*1D Quiet Zone Level 1
(1)



1D Quiet Zone Level 2
(2)



1D Quiet Zone Level 3
(3)

Intercharacter Gap Size

Parameter # 381

SSI # F0h, 7Dh

The Code 39 and Codabar symbologies have an intercharacter gap that is typically quite small. Due to various bar code printing technologies, this gap can grow larger than the maximum size allowed, preventing the scanner from decoding the symbol. If this problem occurs, scan the **Large Intercharacter Gaps** parameter to tolerate these out-of-specification bar codes.



***Normal Intercharacter Gaps**
(6)



Large Intercharacter Gaps
(10)

Composite

Composite CC-C

Parameter # 341

SSI # F0h 55h

Scan one of the following bar codes to enable or disable Composite bar codes of type CC-C.

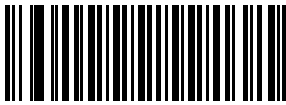

Enable CC-C
(1)



*Disable CC-C
(0)

Composite CC-A/B

Parameter # 342

SSI # F0h 56h

Scan one of the following bar codes to enable or disable Composite bar codes of type CC-A/B.

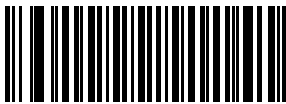

Enable CC-A/B
(1)

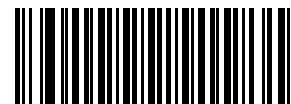

*Disable CC-A/B
(0)

Composite TLC-39

Parameter # 371

SSI # F0h 73h

Scan one of the following bar codes to enable or disable Composite bar codes of type TLC-39.

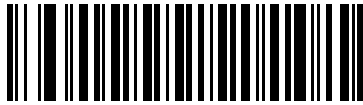

Enable TLC39
(1)



*Disable TLC39
(0)

Composite Inverse

Parameter # 1113

SSI # F8h 04h 59h

Select an option to set Composite for either regular decode or inverse decode. This mode only supports Composite Inverse that includes DataBar combined with CCAB, and does not support other 1D/2D combinations.

For this parameter to function, first enable *Composite CC-A/B* on page 12-86.

- **Regular Only** - The scanner decodes regular Composite bar codes only. Before selecting this, set *Inverse 1D* on page 12-75 to **Regular Only** or **Inverse Autodetect**.
- **Inverse Only** - The scanner decodes inverse Composite bar codes only. Before selecting this, set *Inverse 1D* on page 12-75 to **Inverse Only** or **Inverse Autodetect**.



*Regular Only
(0)



Inverse Only
(1)

UPC Composite Mode

Parameter # 344

SSI # F0h 58h

Select an option for linking UPC symbols with a 2D symbol during transmission as if they were one symbol:

- **UPC Never Linked** - Transmit UPC bar codes regardless of whether a 2D symbol is detected.
- **UPC Always Linked** - Transmit UPC bar codes and the 2D portion. If 2D is not present, do not transmit the bar code.
- **Autodiscriminate UPC Composites** - The scanner determines if there is a 2D portion, then transmits the UPC, as well as the 2D portion if present.



***UPC Never Linked**
(0)



UPC Always Linked
(1)



Autodiscriminate UPC Composites
(2)

Composite Beep Mode

Parameter # 398

SSI # F0h, 8Eh

Scan one of the following bar codes to select the number of decode beeps that sound upon decoding a Composite bar code.

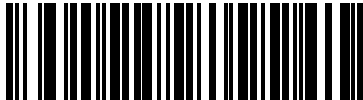

Single Beep After Both are Decoded
(0)



*Beep as Each Code Type is Decoded
(1)

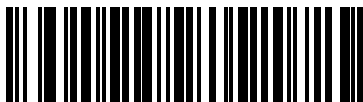

Double Beep After Both are Decoded
(2)

GS1-128 Emulation Mode for UCC/EAN Composite Codes

Parameter # 427

SSI # F0h, ABh

Scan one of the following bar codes to enable or disable this mode.



Enable GS1-128 Emulation Mode for
UCC/EAN Composite Codes
(1)



*Disable GS1-128 Emulation Mode for
UCC/EAN Composite Codes
(0)

2D Symbologies

PDF417

Parameter # 15

SSI # 0Fh

Scan one of the following bar codes to enable or disable PDF417.



***Enable PDF417**
(1)



Disable PDF417
(0)

MicroPDF417

Parameter # 227

SSI # E3h

Scan one of the following bar codes to enable or disable MicroPDF417.



Enable MicroPDF417
(1)



***Disable MicroPDF417**
(0)

Code 128 Emulation

Parameter # 123

SSI # 7Bh

Enable this parameter to transmit data from certain MicroPDF417 symbols as Code 128. You must enable *AIM Code ID Character (1)* on page 10-35 for this parameter to work.

Enable Code 128 Emulation to transmit these MicroPDF417 symbols with one of the following prefixes:

-]C1 if the first codeword is 903-905
-]C2 if the first codeword is 908 or 909
-]C0 if the first codeword is 910 or 911

Disable Code 128 Emulation to transmit these MicroPDF417 symbols with one of the following prefixes:

-]L3 if the first codeword is 903-905
-]L4 if the first codeword is 908 or 909
-]L5 if the first codeword is 910 or 911

Scan one of the following bar codes to enable or disable Code 128 Emulation.

✓ **NOTE** Linked MicroPDF codewords 906, 907, 912, 914, and 915 are not supported. Use GS1 Composites instead.



**Enable Code 128 Emulation
(1)**



***Disable Code 128 Emulation
(0)**

Data Matrix

Parameter # 292

SSI # F0h, 24h

Scan one of the following bar codes to enable or disable Data Matrix.



***Enable Data Matrix
(1)**



**Disable Data Matrix
(0)**

GS1 Data Matrix

Parameter # 1336

SSI # F8h 05h 38h

Scan one of the following bar codes to enable or disable GS1 Data Matrix.



**Enable GS1 Data Matrix
(1)**



***Disable GS1 Data Matrix
(0)**

Data Matrix Inverse

Parameter # 588

SSI # F1h 4Ch

Scan one of the following bar codes to select the Data Matrix inverse decoder setting:

- **Regular Only** - The scanner decodes regular Data Matrix bar codes only.
- **Inverse Only** - The scanner decodes inverse Data Matrix bar codes only.
- **Inverse Autodetect** - The scanner decodes both regular and inverse Data Matrix bar codes.



Regular Only
(0)



Inverse Only
(1)



***Inverse Autodetect**
(2)

Decode Data Matrix Mirror Images

Parameter # 537

SSI # F1h 19h

Scan one of the following bar codes to select an option for decoding mirror image Data Matrix bar codes:

- **Never** - Do not decode Data Matrix bar codes that are mirror images.
- **Always** - Decode only Data Matrix bar codes that are mirror images.
- **Auto** - Decode both mirrored and unmirrored Data Matrix bar codes.



Never
(0)



Always
(1)



***Auto**
(2)

Maxicode

Parameter # 294

SSI # F0h, 26h

Scan one of the following bar codes to enable or disable Maxicode.



**Enable Maxicode
(1)**



***Disable Maxicode
(0)**

QR Code

Parameter # 293

SSI # F0h, 25h

Scan one of the following bar codes to enable or disable QR Code.

✓ **NOTE** Inverse QR bar codes decode if QR Code is enabled.



***Enable QR Code
(1)**



**Disable QR Code
(0)**

GS1 QR

Parameter # 1343

SSI # F8h 05h 3Fh

Scan one of the following bar codes to enable or disable GS1 QR.



**Enable GS1 QR
(1)**



***Disable GS1 QR
(0)**

MicroQR

Parameter # 573

SSI # F1h 3Dh

Scan one of the following bar codes to enable or disable MicroQR.



***Enable MicroQR
(1)**



**Disable MicroQR
(0)**

Linked QR Mode

Parameter # 1847

SSI # 737h

Scan one of the following barcodes to select a linked QR mode:

- **Linked QR Only** - the digital scanner does not decode individual QR symbols from a set of Linked QR codes.
- **Individual QR With Headers** - the digital scanner decodes individual QR symbols from a set of Linked QR codes and retains the header information and data.
- **Individual QR No Headers** - the digital scanner decodes individual QR symbols from a set of Linked QR codes and transmits the data without header information.



* **Linked QR Only**
(0)



Individual QR With Headers
(1)

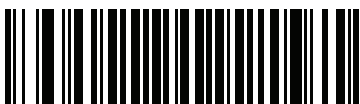

Individual QR No Headers
(2)

Aztec

Parameter # 574

SSI # F1h 3Eh

Scan one of the following bar codes to enable or disable Aztec.

✓ **NOTE** Enabling this also enables Linked Aztec.



***Enable Aztec
(1)**



**Disable Aztec
(0)**

Aztec Inverse

Parameter # 589

SSI # F1h 4Dh

Scan one of the following bar codes to select the Aztec inverse decoder setting:

- **Regular Only** - The scanner decodes regular Aztec bar codes only.
- **Inverse Only** - The scanner decodes inverse Aztec bar codes only.
- **Inverse Autodetect** - The scanner decodes both regular and inverse Aztec bar codes.



Regular Only
(0)



Inverse Only
(1)



***Inverse Autodetect**
(2)

Han Xin

Parameter # 1167

SSI # F8h 04h 8Fh

Scan one of the following bar codes to enable or disable Han Xin.



**Enable Han Xin
(1)**



***Disable Han Xin
(0)**

Han Xin Inverse

Parameter # 1168

SSI # F8h 04h 90h

Scan one of the following bar codes to select a Han Xin inverse decoder setting:

- **Regular Only** - The scanner decodes Han Xin bar codes with normal reflectance only.
- **Inverse Only** - The scanner decodes Han Xin bar codes with inverse reflectance only.
- **Inverse Autodetect** - The scanner decodes both regular and inverse Han Xin bar codes.

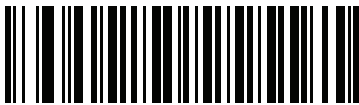

***Regular Only**
(0)

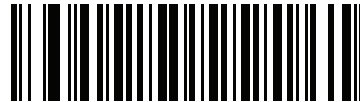

Inverse Only
(1)

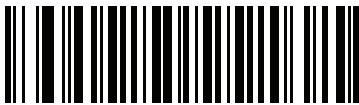

Inverse Autodetect
(2)

Grid Matrix

Parameter # 1718

SSI # F8h 06h B6h

Scan one of the following bar codes to enable or disable Grid Matrix.



Enable
(1)

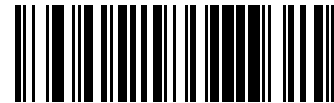

***Disable**
(0)

Grid Matrix Inverse

Parameter # 1719

SSI # F8h 06h B7h

Scan one of the following bar codes to select a Grid Matrix inverse decoder setting:

- **Regular Only** - The scanner decodes regular Grid Matrix bar codes only.
- **Inverse Only** - The scanner decodes inverse Grid Matrix bar codes only.
- **Autodiscriminate** - The scanner decodes both regular and inverse Grid Matrix bar codes.



***Regular Only**
(0)



Inverse Only
(1)



Autodiscriminate
(2)

Grid Matrix Mirror

Parameter # 1736

SSI # F8h 06h C8h

Scan one of the following bar codes to select a Grid Matrix mirror decoder setting:

- **Regular Only** - The scanner decodes regular Grid Matrix bar codes only.
- **Mirrored Only** - The scanner decodes mirrored Grid Matrix bar codes only.
- **Auto-discriminate** - The scanner decodes both regular and mirrored Grid Matrix bar codes.



***Regular Only**
(0)



Mirrored Only
(1)



Autodiscriminate
(2)

DotCode

Parameter # 1906

SSI # F8 07 72h

Scan one of the following barcodes to enable or disable DotCode.

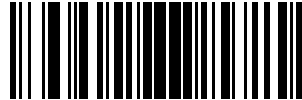

*** Disable DotCode
(0)**

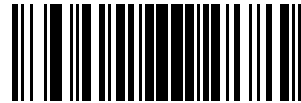

**Enable DotCode
(1)**

DotCode Inverse

Parameter # 1907

SSI # F8 07 73h

Scan one of the following barcodes to select a DotCode Inverse decoder setting. Setting options are:

- **Regular Only** - Decoder decodes DotCode barcodes with normal reflectance only.
- **Inverse Only** - Decoder decodes DotCode barcodes with inverse reflectance only.
- **Inverse Autodetect** - Decoder decodes both regular and inverse DotCode barcodes.

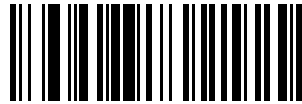

Regular
(0)

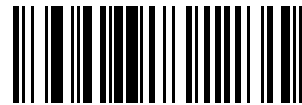

Inverse Only
(1)



*** Autodetect**
(2)

DotCode Mirrored**Parameter # 1908****SSI # F8 07 74h**

Scan one of the following barcodes to select a DotCode Mirror decoder setting:

- **Non-Mirrored Only** - Digital scanner decodes non-mirrored DotCode barcodes only.
- **Mirrored Only** - Digital scanner decodes mirrored DotCode barcodes only.
- **Autodetect** - Digital scanner decodes both mirrored and non-mirrored DotCode barcodes.

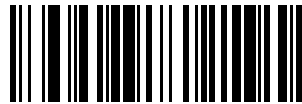

Never
(0)

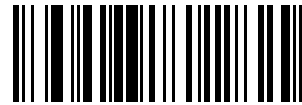

Always
(1)

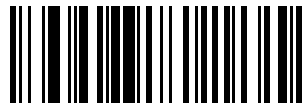

*** Autodetect**
(2)

DotCode Prioritize

Parameter # 1937

SSI # F8 07 91h

Enable DotCode Prioritize to give priority to DotCode decoding as compared to other symbologies.



* Disable



Enable

Macro PDF Features

Macro PDF is a special feature for concatenating multiple PDF symbols into one file. The scanner can decode symbols encoded with this feature, and can store more than 64 Kb of decoded data from up to 50 MacroPDF symbols.



CAUTION When printing, keep each Macro PDF sequence separate, as each sequence has unique identifiers. Do not mix bar codes from several Macro PDF sequences, even if they encode the same data. When scanning a Macro PDF sequence, scan the entire sequence without interruption. When scanning a mixed sequence, two long low beeps (low / low) indicate an inconsistent file ID or inconsistent symbology error.

Flush Macro Buffer

Scan the following bar code to flush the buffer of all decoded Macro PDF data stored to that point, transmit it to the host device, and abort from Macro PDF mode.



Flush Macro PDF Buffer

Abort Macro PDF Entry

Scan the following bar code to clear all currently-stored Macro PDF data in the buffer without transmission and abort from Macro PDF mode.



Abort Macro PDF Entry

Postal Codes

US Postnet

Parameter # 89

SSI # 59h

Scan one of the following bar codes to enable or disable US Postnet.



**Enable US Postnet
(1)**



***Disable US Postnet
(0)**

US Planet

Parameter # 90

SSI # 5Ah

Scan one of the following bar codes to enable or disable US Planet.



**Enable US Planet
(1)**



***Disable US Planet
(0)**

Transmit US Postal Check Digit

Parameter # 95

SSI # 5Fh

Scan one of the following bar codes to select whether to transmit US Postal data, which includes both US Postnet and US Planet, with or without the check digit.

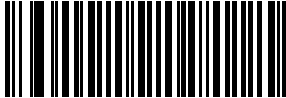

***Transmit US Postal Check Digit
(1)**



**Do Not Transmit US Postal Check Digit
(0)**

UK Postal

Parameter # 91

SSI # 5Bh

Scan one of the following bar codes to enable or disable UK Postal.



**Enable UK Postal
(1)**



***Disable UK Postal
(0)**

Transmit UK Postal Check Digit

Parameter # 96

SSI # 60h

Scan one of the following bar codes to select whether to transmit UK Postal data with or without the check digit.



***Transmit UK Postal
Check Digit
(1)**



**Do Not Transmit UK Postal Check Digit
(0)**

Japan Postal

Parameter # 290

SSI # F0h, 22h

Scan one of the following bar codes to enable or disable Japan Postal.



**Enable Japan Postal
(1)**



***Disable Japan Postal
(0)**

Australia Post

Parameter # 291

SSI # F0h, 23h

Scan one of the following bar codes to enable or disable Australia Post.



Enable Australia Post
(1)



***Disable Australia Post**
(0)

Australia Post Format

Parameter # 718

SSI # F1h, CEh

Scan one of the following bar codes to select a format for Australia Post:

- **Autodiscriminate** (or Smart mode) - Decode the Customer Information Field using the N and C Encoding Tables.

✓ **NOTE** This option increases the risk of misdecodes because the encoded data format does not specify the Encoding Table used for encoding.

- **Raw Format** - Output raw bar patterns as a series of numbers 0 through 3.
- **Alphanumeric Encoding** - Decode the Customer Information Field using the C Encoding Table.
- **Numeric Encoding** - Decode the Customer Information Field using the N Encoding Table.

For more information on Australia Post Encoding Tables, refer to the *Australia Post Customer Barcoding Technical Specifications* available at auspost.com.au.



*Autodiscriminate
(0)



Raw Format
(1)



Alphanumeric Encoding
(2)



Numeric Encoding
(3)

Netherlands KIX Code

Parameter # 326

SSI # F0h, 46h

Scan one of the following bar codes to enable or disable Netherlands KIX Code.



**Enable Netherlands KIX Code
(1)**



***Disable Netherlands KIX Code
(0)**

USPS 4CB/One Code/Intelligent Mail

Parameter # 592

SSI # F1h 50h

Scan one of the following bar codes to enable or disable USPS 4CB/One Code/Intelligent Mail.



**Enable USPS 4CB/One Code/Intelligent Mail
(1)**



***Disable USPS 4CB/One Code/Intelligent Mail
(0)**

UPU FICS Postal

Parameter # 611

SSI # F1h 63h

Scan one of the following bar codes to enable or disable UPU FICS Postal.

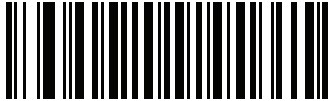

Enable UPU FICS Postal
(1)

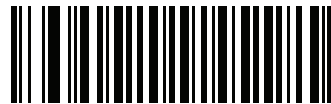

*Disable UPU FICS Postal
(0)

Mailmark

Parameter # 1337

SSI # F8h 05h 39h

Scan one of the following bar codes to enable or disable Mailmark.

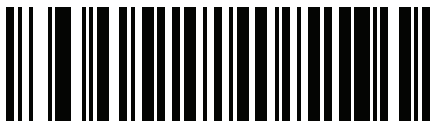

*Disable Mailmark
(0)

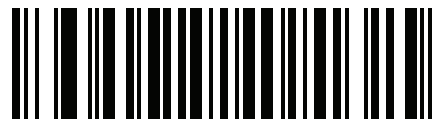

Enable Mailmark
(1)

CHAPTER 13 OCR PROGRAMMING

Introduction

This chapter describes how to set up the scanner for OCR programming. The scanner can read 6 to 60 point OCR typeface. It supports font types OCR-A, OCR-B, MICR E13B, and US Currency Serial Number.

OCR is not as secure as a bar code. To decrease OCR misdecodes and speed OCR reading, set an accurate OCR template and character subset, and use a check digit.

All OCR fonts are disabled by default. Enabling OCR could slow bar code decoding. You can enable OCR-A and OCR-B at the same time, but not other combined font types.

Setting Parameters

To set feature values, scan a single bar code or a short bar code sequence. The settings are stored in non-volatile memory and are preserved even when the imager powers down.

✓ **NOTE** Most computer monitors allow scanning bar codes directly on the screen. When scanning from the screen, be sure to set the document magnification to a level where you can see the bar code clearly, and bars and/or spaces do not merge.

To return all features to default values, scan the *Set Factory Defaults on page 10-5*. Throughout the programming bar code menus, asterisks (*) indicate default values.



* Indicates default *Enable Parameter (1) Feature/option
Option value

Scanning Sequence Examples

In most cases scanning one bar code sets the parameter value. For example, to enable OCR-B, scan the **Enable OCR-B** bar code under *OCR-B on page 13-5*. The scanner issues a fast warble beep and the LED turns green, signifying a successful parameter entry.

Other parameters require scanning several bar codes. See the parameter descriptions for this procedure.

Errors While Scanning

Unless otherwise specified, to correct an error during a scanning sequence, just re-scan the correct parameter.

OCR Parameter Defaults

[Table 13-1](#) lists the defaults for OCR parameters. Change these values in one of two ways:

- Scan the appropriate bar codes in this chapter. The new value replaces the standard default value in memory. To recall default parameter values, see *Default Parameters on page 10-5*.
- Configure the scanner using the 123Scan configuration program. See [Chapter 2, 123Scan and Software Tools](#).

✓ **NOTE** See [Appendix A, Standard Parameter Defaults](#) for all user preference, host, symbology, and miscellaneous default parameters.

Table 13-1 OCR Programming Default Table

Parameter	Parameter Number	SSI Number	Default	Page Number
OCR Programming Parameters				
OCR-A	680	F1h A8h	Disable	13-3
OCR-A Variant	684	F1h ACh	OCR-A Full ASCII	13-4
OCR-B	681	F1h A9h	Disable	13-5
OCR-B Variant	685	F1h ADh	OCR-B Full ASCII	13-6
MICR E13B	682	F1h AAh	Disable	13-10
US Currency	683	F1h ABh	Disable	13-11
OCR Orientation	687	F1h AFh	0°	13-11
OCR Lines	691	F1h B3h	1	13-13
OCR Minimum Characters	689	F1h B1h	3	13-13
OCR Maximum Characters	690	F1h B2h	100	13-14
OCR Subset	686	F1h AEh	Selected font variant	13-14
OCR Quiet Zone	695	F1h B7h	50	13-15

Table 13-1 OCR Programming Default Table (Continued)

Parameter	Parameter Number	SSI Number	Default	Page Number
OCR Template	547	F1h 23h	99999999	13-15
OCR Check Digit Modulus	688	F1h B0h	1	13-25
OCR Check Digit Multiplier	700	F1h BCh	121212121212	13-26
OCR Check Digit Validation	694	F1h B6h	None	13-27
Inverse OCR	856	F2h 58h	Regular	13-32
OCR Redundancy	1770	F8h 06h EAh	Level 1	13-33

OCR Programming Parameters

OCR-A

Parameter # 680

SSI # F1h A8h

Scan one of the following bar codes to enable or disable OCR-A.

- ✓ **NOTE** OCR is not as secure as a bar code. To decrease OCR misdecodes and speed OCR reading, set an accurate OCR template and character subset, and use a check digit. See *OCR Subset on page 13-14* and *OCR Template on page 13-15*.



Enable OCR-A
(1)



***Disable OCR-A**
(0)

OCR-A Variant

Parameter # 684

SSI # F1 ACh

The font variant sets a processing algorithm and default character subset for the given font. To choose a variant, scan one of the following bar codes. Select the most appropriate font variant to optimize performance and accuracy.

OCR-A supports the following variants:

- OCR-A Full ASCII
!"#\$()*+,-./0123456789<>ABCDEFGHIJKLMNOPQRSTUVWXYZ^
- OCR-A Reserved 1
\$*+,-./0123456789ABCDEFGHIJKLMNOPQRSTUVWXYZ
- OCR-A Reserved 2
\$*+,-./0123456789<>ABCDEFGHIJKLMNOPQRSTUVWXYZ
- OCR-A Banking
-0123456789<> ƴ Ɔ Ɔ

Special banking characters output as the following representative characters:

ƴ outputs as f

Ɔ outputs as c

Ɔ outputs as h

✓ **NOTE** Enable OCR-A before setting this parameter. If disabling OCR-A, set the variant to its default (OCR-A Full ASCII).

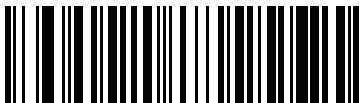

*OCR-A Full ASCII
(0)

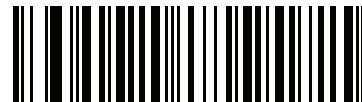

OCR-A Reserved 1
(1)

OCR-A Variant (continued)

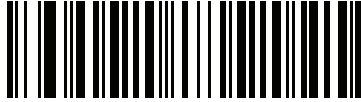

OCR-A Reserved 2
(2)



OCR-A Banking
(3)

OCR-B

Parameter # 681

SSI # F1h A9h

Scan one of the following bar codes to enable or disable OCR-B.



NOTE OCR is not as secure as a bar code. To decrease OCR misdecodes and speed OCR reading, set an accurate OCR template and character subset, and use a check digit. See *OCR Subset on page 13-14* and *OCR Template on page 13-15*.



Enable OCR-B
(1)



*Disable OCR-B
(0)

OCR-B Variant**Parameter # 685****SSI # F1h ADh**

OCR-B has the following variants. Select the most appropriate font variant to optimize performance and accuracy.

- OCR-B Full ASCII
!#\$%()*+,-./0123456789<>ABCDEFGHIJKLMNOPQRSTUVWXYZ^|ñ
- OCR-B Banking
#+-0123456789<>JNP|
- OCR-B Limited
+,-./0123456789<>ACENPSTVX
- OCR-B ISBN 10-Digit Book Numbers
-0123456789>BCEINPSXz
- OCR-B ISBN 10 or 13-Digit Book Numbers
-0123456789>BCEINPSXz
- OCR-B Travel Document Version 1 (TD1) 3-Line ID Cards
-0123456789<ABCDEFGHIJKLMNOPQRSTUVWXYZ
- OCR-B Travel Document Version 2 (TD2) 2-Line ID Cards
-0123456789<ABCDEFGHIJKLMNOPQRSTUVWXYZ
- OCR-B Travel Document 2 or 3-Line ID Cards Auto-Detect
!#\$%()*+,-./0123456789<>ABCDEFGHIJKLMNOPQRSTUVWXYZ^|ñ
- OCR-B Passport
-0123456789<ABCDEFGHIJKLMNOPQRSTUVWXYZñ
- OCR-B Visa Type A
-0123456789<ABCDEFGHIJKLMNOPQRSTUVWXYZ
- OCR-B Visa Type B
-0123456789<ABCDEFGHIJKLMNOPQRSTUVWXYZñ
- OCR-B ICAO Travel Documents
This allows reading either TD1, TD2, Passport, Visa Type A, or Visa Type B without switching between these options. It automatically recognizes the travel document read.
Scanning any ISBN Book Number automatically applies the appropriate ISBN checksum.

To choose a variant, scan one of the bar codes below. Selecting the following OCR-B variants automatically sets the appropriate *OCR Lines* on page 13-13. These five variants invoke extensive special algorithms and checking for that particular document type:

Variant	OCR Lines Setting
Passport	2
TD1 ID Cards	3
TD2 ID Cards	2
Visa Type A	2
Visa Type B	2

✓ **NOTE** When setting one of the variants above with both OCR-A and OCR-B enabled, the scanner reads the specified travel document but does not read OCR-A. When the OCR-B variant is set back to the default (OCR-B Full ASCII), the scanner reads OCR-A.

✓ **NOTE** Enable OCR-B before setting this parameter. If disabling OCR-B, set the variant to its default (OCR-B Full ASCII).



*OCR-B Full ASCII
(0)



OCR-B Banking
(1)



OCR-B Limited
(2)



OCR-B ISBN 10-Digit Book Numbers
(6)

OCR-B Variant (continued)



OCR-B ISBN 10 or 13-Digit Book Numbers
(7)



OCR-B Travel Document Version 1 (TD1)
3 Line ID Cards
(3)



OCR-B Travel Document Version 2 (TD2)
2-Line ID Cards
(8)

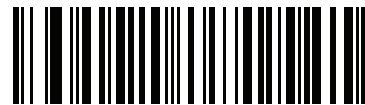

Travel Document 2 or 3-Line ID Cards Auto-Detect
(20)



OCR-B Passport
(4)

OCR-B Variant (continued)



**OCR-B Visa Type A
(9)**



**OCR-B Visa Type B
(10)**



**OCR-B ICAO Travel Documents
(11)**

MICR E13B

Parameter # 682

SSI # F1h AAh

Scan one of the following bar codes to enable or disable MICR E13B.

MICR E 13B uses the following characters:

0 1 2 3 4 5 6 7 8 9 t a o d

TOAD characters (Transit, On Us, Amount, and Dash) output as the following representative characters:

t outputs as t

a outputs as a

o outputs as o

d outputs as d

✓ **NOTE** OCR is not as secure as a bar code. To decrease OCR misdecodes and speed OCR reading, set an accurate OCR template and character subset, and use a check digit. See *OCR Subset on page 13-14* and *OCR Template on page 13-15*.



Enable MICR E13B
(1)



*Disable MICR E13B
(0)

US Currency Serial Number

Parameter # 683

SSI # F1h ABh

Scan one of the following bar codes to enable or disable US Currency Serial Number.

- ✓ **NOTE** OCR is not as secure as a bar code. To decrease OCR misdecodes and speed OCR reading, set an accurate OCR template and character subset, and use a check digit. See *OCR Subset on page 13-14* and *OCR Template on page 13-15*.



**Enable US Currency
(1)**

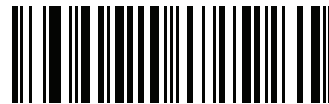

***Disable US Currency
(0)**

OCR Orientation

Parameter # 687

SSI # F1h AFh

Select one of five options to specify the orientation of the OCR to read:

- 0° to the imaging engine (default)
- 270° clockwise (or 90° counterclockwise) to the imaging engine
- 180° (upside down) to the imaging engine
- 90° clockwise to the imaging engine
- Omnidirectional

Setting an incorrect orientation can cause misdecodes.

OCR Orientation (continued)



***OCR Orientation 0°
(0)**



**OCR Orientation 270° Clockwise
(1)**



**OCR Orientation 180° Clockwise
(2)**



**OCR Orientation 90° Clockwise
(3)**



**OCR Orientation Omnidirectional
(4)**

OCR Lines

Parameter # 691

SSI # F1h B3h

To select the number of OCR lines to decode, scan one of the following bar codes. Selecting Visas, TD1, or TD2 ID cards automatically sets the appropriate **OCR Lines**. Also see *OCR-B Variant on page 13-6*.

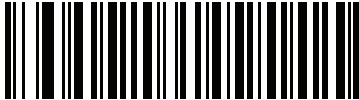

***OCR 1 Line
(1)**



**OCR 2 Lines
(2)**



**OCR 3 Lines
(3)**

OCR Minimum Characters

Parameter # 689

SSI # F1h B1h

To select the minimum number of OCR characters (not including spaces) per line to decode, scan the following bar code, then scan a three-digit number between 003 and 100 using the bar codes in [Appendix B, Numeric Bar Codes](#) representing the number of OCR characters to decode. Strings of OCR characters less than the minimum are ignored. The default is 003.



OCR Minimum Characters

OCR Maximum Characters

Parameter # 690

SSI # F1h B2h

To select the maximum number of OCR characters (including spaces) per line to decode, scan the following bar code, then scan a three-digit number between 003 and 100 using the bar codes in [Appendix B, Numeric Bar Codes](#) representing the number of OCR characters to decode. Strings of OCR characters greater than the maximum are ignored. The default is 100.



OCR Maximum Characters

OCR Subset

Parameter # 686

SSI # F1h AEh

Create an OCR subset to define a custom group of characters in place of a preset font variant. For example, if scanning only numbers and the letters A, B, and C, create a subset of just these characters to speed decoding. This applies a designated OCR Subset across all enabled OCR fonts.

To set or modify the OCR font subset:

1. Enable the appropriate OCR font(s).
2. Scan the **OCR Subset** bar code.
3. Scan numbers and letters to form the OCR Subset from [Appendix C, Alphanumeric Bar Codes](#).
4. Scan *End of Message on page C-8*.

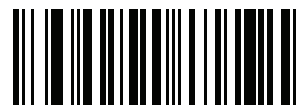

OCR Subset

To cancel an OCR subset, for OCR-A or OCR-B, scan OCR-A variant **Full ASCII**, or OCR-B variant **Full ASCII**.

For MICR E13B or US Currency Serial Number, create a subset which includes all allowed characters in that character set, or scan an option from the *Default Parameters on page 10-5* and re-program the scanner.

OCR Quiet Zone

Parameter # 695

SSI # F1h B7h

This option sets the OCR quiet zone. The scanner stops scanning a field when it detects a sufficiently wide blank space. The width of this space is defined by the End of Field option. Used with parsers that tolerate slanted characters, the End of Field count is approximately a count of 8 for a character width. For example, if set to 15, then two character widths are an end of line indicator for the parser. Larger end of field numbers require bigger quiet zones at each end of text line.

To set a quiet zone, scan the following bar code, then scan a two-digit number using the numeric keypad in [Appendix B, Numeric Bar Codes](#). The range of the quiet zone is 20 - 99 and the default is 50, indicating a six character width quiet zone.



OCR Quiet Zone

OCR Template

Parameter # 547

SSI # F1h 23h

This option creates a template for precisely matching scanned OCR characters to a desired input format. Appropriate OCR template needs to be set before using OCR features.

To set or modify the OCR decode template, scan the [OCR Template](#) bar code, and then scan bar codes on the following pages that correspond to numbers and letters to form the template expression. Then scan **End of Message**. The default is **99999999** which accepts OCR strings only containing eight digits.

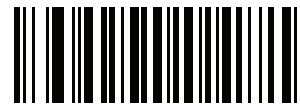

OCR Template



End of Message

Required Digit (9)

Only a numeric character is accepted in this position.

Template	Valid data	Valid data	Invalid data
99999	12987	30517	123AB



9

Required Alpha (A)

Only an alpha character is accepted in this position.

Template	Valid data	Valid data	Invalid data
AAAAA	ABCDE	UVWXY	12FGH



A

Optional Alphanumeric (1)

An alphanumeric character is accepted in this position if present. Optional characters are not allowed as the first character(s) in a field of like characters.

Template	Valid data	Valid data	Invalid data
99991	1234A	12345	1234<



1

Optional Alpha (2)

An alpha character is accepted in this position if present. Optional characters are not allowed as the first character(s) in a field of like characters.

Template	Valid data	Valid data	Invalid data
AAAA2	ABCDE	WXYZ	ABCD6



2

Alpha or Digit (3)

An alphanumeric character is required in this position to validate the incoming data.

Template	Valid data	Valid data	Invalid data
33333	12ABC	WXYZ34	12AB<



3

Any Including Space & Reject (4)

Any character is accepted in this position, including space and reject. An underscore () represents rejects in the output. This is a good selection for troubleshooting.

Template	Valid data	Valid data
99499	12\$34	34 98



4

Any except Space & Reject (5)

Any character is accepted in this position, except a space or reject.

Template	Valid data	Valid data	Invalid data
55999	A.123	*Z456	A BCD



5

Optional Digit (7)

A numeric character is accepted if present. Optional characters are not allowed as the first character(s) in a field of like characters.

Template	Valid data	Valid data	Invalid data
99977	12345	789	789AB



7

Digit or Fill (8)

Any numeric or fill character is accepted in this position.

Template	Valid data	Valid data	Valid data
88899	12345	>>789	<<789



8

Alpha or Fill (F)

Any alpha or fill character is accepted in this position.

Template	Valid data	Valid data	Valid data
AAAFF	ABCXY	LMN>>	ABC<5



F

Optional Space ()

A space is accepted if present. Optional characters are not allowed as the first character(s) in a field of like characters.

Template	Valid data	Valid data	Invalid data
99 99	12 34	1234	67891



Space

Optional Small Special (.)

A special character is accepted if present. Optional characters are not allowed as the first character(s) in a field of like characters. Small special characters are - , and .

Template	Valid data	Valid data	Invalid data
AA.99	MN.35	XY98	XYZ12



.

Other Template Operators

These template operators assist in capturing, delimiting, and formatting scanned OCR data.

Literal String (" and +)

Use either of these delimiting characters surrounding characters from the alphanumeric keyboard in [Appendix C, Alphanumeric Bar Codes](#) to define a literal string within a template that must be present in scanned OCR data.

There are two characters used to delimit required literal strings; if one of the delimiter characters is present in the desired literal string, use the other delimiter.

Template	Valid data	Invalid data
"35+BC"	35+BC	AB+22



"



+

New Line (E)

To create a template of multiple lines, add **E** between the template of each single line.

Template	Valid data	Valid data	Invalid data
999EAAAA	321	987	XYZW
	BCAD	ZXYW	12



E

String Extract (C)

This operator combined with others defines a string of characters to extract from the scanned data. The string extract is structured as follows:

`CbPe`

Where:

- `C` is the string extract operator
- `b` is the string begin delimiter
- `P` is the category (one or more numeric or alpha characters) describing the string representation
- `e` is the string end delimiter

Values for `b` and `e` can be any scannable character. They are included in the output stream.

Template	Incoming data	Output
<code>C>A></code>	<code>XQ3>ABCDE></code>	<code>>ABCDE></code>
	<code>->ATHRUZ>123</code>	<code>>ATHRUZ></code>
	<code>1ABCXYZ</code>	No Output



C

Ignore to End of Field (D)

This operator causes all characters after a template to be ignored. Use this as the last character in a template expression. Examples for the template `999D`:

Template	Incoming data	Output
<code>999D</code>	<code>123-PED</code>	<code>123</code>
	<code>357298</code>	<code>357</code>
	<code>193</code>	<code>193</code>



D

Skip Until (P1)

This operator skips over characters until a specific character type or a literal string is detected. It can be used in two ways:

P1ct

Where:

- P1 is the Skip Until operator
- c is the type of character that triggers the start of output
- t is one or more template characters

P1"s"t

Where:

- P1 is the Skip Until operator
- "s" is one or more literal string characters (see *Literal String (" and +) on page 13-20*) that trigger the start of output
- t is one or more template characters

The trigger character or literal string is included in output from a Skip Until operator, and the first character in the template should accommodate this trigger.

Template	Incoming data	Output
P1"PN"AA9999	123PN9876	PN9876
	PN1234	PN1234
	X-PN3592	PN3592



P



1

Skip Until Not (P0)

This operator skips over characters until a specific character type or a literal string is not matched in the output stream. It can be used in two ways:

```
P0ct
```

Where:

- P0 is the Skip Until Not operator
- c is the type of character that triggers the start of output
- t is one or more template characters

```
P0"s"t
```

Where:

- P0 is the Skip Until Not operator
- "s" is one or more literal string characters (see *Literal String (" and +) on page 13-20*) that trigger the start of output
- t is one or more template characters

The trigger character or literal string is not included in output from a Skip Until Not operator.

Template	Incoming data	Output
P0A9999	BP3456	3456
	PN1234	1234
	5341	No output
Template	Incoming data	Output
P0"PN"9999	PN3456	3456
	5341	No output
	PNPN7654	7654



P



0

Repeat Previous (R)

This operator allows a template character to repeat one or more times, allowing the capture of variable-length scanned data. The following examples capture two required alpha characters followed by one or more required digits:

Template	Incoming data	Output
AA9R	AB3	AB3
	PN12345	PN12345
	32RM52700	No output



R

Scroll Until Match (S)

This operator steps through scanned data one character at a time until the data matches the template.

Template	Incoming data	Output
S99999	AB3	No Output
	PN12345	12345
	32RM52700	52700



S

Multiple Templates

This feature sets up multiple templates for OCR decoding. To do this, follow the procedure described in *OCR Template on page 13-15* (scan the [OCR Template](#) bar code, and then bar codes corresponding to numbers and letters to form the template expression, and then **End of Message**) for each template in the multiple template string, using a capital letter **X** as a separator between templates.

For example, set the [OCR Template](#) as **99999XAAAAA** to decode OCR strings of either **12345** or **ABCDE**.

Template Examples

Following are sample templates with descriptions of valid data for each definition.

Field Definition	Description
"M"99977	M followed by three digits and two optional digits.
"X"997777"X"	X followed by two digits, four optional digits, and an X .
9959775599	Two digits followed by any character, a digit, two optional digits, any two characters, and two digits.
A55"- "999"- "99	A letter followed by two characters, a dash, three digits, a dash, and two digits.
33A". "99	Two alphanumeric characters followed by a letter, a period, and two digits.
999992991	Five digits followed by an optional alpha, two digits, and an optional alphanumeric.
"PN98"	Literal field - PN98

OCR Check Digit Modulus

Parameter # 688

SSI # F1h B0h

The check digit is the last digit (in the right-most position) in an OCR string and improves the accuracy of the collected data. This option sets OCR module check digit calculation. The calculation is performed on incoming data to determine this check digit, based on the numeric weight of the alpha and numeric characters. See *OCR Check Digit Multiplier on page 13-26*. If the incoming data does not match the check digit, the data is considered corrupt.

The selected check digit option does not take effect until you set *OCR Check Digit Validation on page 13-27*.

To choose the Check Digit Modulus, such as 10 for Modulus 10, scan the following bar code, and then scan a three-digit number from 001 to 099 representing the check digit using the numeric keypad in [Appendix B, Numeric Bar Codes](#). The default is 1.



OCR Check Digit

OCR Check Digit Multiplier

Parameter # 700

SSI # F1h BCh

This option sets OCR check digit multipliers for character positions. For check digit validation, each character in scanned data has an assigned weight to use in calculating the check digit. The scanner OCR ships with the following weight equivalents:

0 = 0	A = 10	K = 20	U = 30
1 = 1	B = 11	L = 21	V = 31
2 = 2	C = 12	M = 22	W = 32
3 = 3	D = 13	N = 23	X = 33
4 = 4	E = 14	O = 24	Y = 34
5 = 5	F = 15	P = 25	Z = 35
6 = 6	G = 16	Q = 26	Space = 0
7 = 7	H = 17	R = 27	
8 = 8	I = 18	S = 28	
9 = 9	J = 19	T = 29	

All other characters are equivalent to one (1).

You can define the multiplier string if it is different from the default.

121212121212 (default)

123456789A (for ISBN, Product Add Right to Left. See *OCR Check Digit Validation on page 13-27*)

For example:

ISBN	0	2	0	1	1	8	3	9	9	4
Multiplier	10	9	8	7	6	5	4	3	2	1
Product	0	18	0	7	6	40	12	27	18	4
Product add	0+	18+	0+	7+	6+	40+	12+	27+	18+	4= 132

ISBN uses Modulus 11 for the check digit. In this case, 132 is divisible by 11, so it passes the check digit.

To set the check digit multiplier, scan the following bar code, and then scan numbers and letters to form the multiplier string from [Appendix C, Alphanumeric Bar Codes](#). Then scan *End of Message on page C-8*.



OCR Check Digit Multiplier

OCR Check Digit Validation

Parameter # 694

SSI # F1h B6h

Use the following options to protect against scanning errors by applying a check digit validation scheme.

None

No check digit validation, indicating no check digit is applied. This is the default.



***No Check Digit
(0)**

Product Add Left to Right

Each character in the scanned data is assigned a numeric value (see *OCR Check Digit Multiplier on page 13-26*). Each digit representing a character in the scanned data is multiplied by its corresponding digit in the multiplier, and the sum of these products is computed. The check digit passes if this sum modulo Check Digit Modulus is zero.

Example:

Scanned data numeric value is 132456 (check digit is 6)

Check digit multiplier string is 123456

Digit	1	3	2	4	5	6	
Multiplier	1	2	3	4	5	6	
Product	1	6	6	16	25	36	
Product add	1+	6+	6+	16+	25+	36=	90

The Check Digit Modulus is 10. It passes because 90 is divisible by 10 (the remainder is zero).



**Product Add Left to Right
(3)**

Product Add Right to Left

Each character in the scanned data is assigned a numeric value (see *OCR Check Digit Multiplier on page 13-26*). The check digit multiplier is reversed in order. Each value representing a character in the scanned data is multiplied by its corresponding digit in the reversed multiplier, resulting in a product for each character in the scanned data. The sum of these products is computed. The check digit passes if this sum modulo Check Digit Modulus is zero.

Example:

Scanned data numeric value is 132459 (check digit is 9)

Check digit multiplier string is 123456

Digit	1	3	2	4	5	9	
Multiplier	6	5	4	3	2	1	
Product	6	15	8	12	10	9	
Product add	6+	15+	8+	12+	10+	9=	60

The Check Digit Modulus is 10. It passes because 60 is divisible by 10 (the remainder is 0).



**Product Add Right to Left
(1)**

Digit Add Left to Right

Each character in the scanned data is assigned a numeric value (see *OCR Check Digit Multiplier on page 13-26*). Each value representing a character in the scanned data is multiplied by its corresponding digit in the multiplier, resulting in a product for each character in the scanned data. The sum of each individual digit in all of the products is then calculated. The check digit passes if this sum modulo Check Digit Modulus is zero.

Example:

Scanned data numeric value is 132456 (check digit is 6)

Check digit multiplier string is 123456

Digit	1	3	2	4	5	6	
Multiplier	1	2	3	4	5	6	
Product	1	6	6	16	25	36	
Digit add	1+	6+	6+	1+6+	2+5+	3+6=	36

The Check Digit Modulus is 12. It passes because 36 is divisible by 12 (the remainder is 0).



**Digit Add Left to Right
(4)**

Digit Add Right to Left

Each character in the scanned data is assigned a numeric value (see *OCR Check Digit Multiplier on page 13-26*). The check digit multiplier is reversed in order. Each value representing a character in the scanned data is multiplied by its corresponding digit in the reversed multiplier, resulting in a product for each character in the scanned data. The sum of each individual digit in all of the products is then calculated. The check digit passes if this sum modulo Check Digit Modulus is zero.

Example:

Scanned data numeric value is 132456 (check digit is 6)

Check digit multiplier string is 123456

Digit	1	3	2	4	5	6
Multiplier	6	5	4	3	2	1
Product	6	15	8	12	10	6
Digit add	6+	1+5+	8+	1+2+	1+0+	6= 30

The Check Digit Modulus is 10. It passes because 30 is divisible by 10 (the remainder is 0).



Digit Add Right to Left
(2)

Product Add Right to Left Simple Remainder

Each character in the scanned data is assigned a numeric value (see *OCR Check Digit Multiplier on page 13-26*). The check digit multiplier is reversed in order. Each value representing a character in the scanned data is multiplied by its corresponding digit in the reversed multiplier, resulting in a product for each character in the scanned data. The sum of these products **except for the check digit's product** is computed. The check digit passes if this sum modulo Check Digit Modulus is equal to the check digit's product.

Example:

Scanned data numeric value is 122456 (check digit is 6)

Check digit multiplier string is 123456

Digit	1	2	2	4	5	6
Multiplier	6	5	4	3	2	1
Product	6	10	8	12	10	6
Product add	6+	10+	8+	12+	10=	46 6

The Check Digit Modulus is 10. It passes because 46 divided by 10 leaves a remainder of 6.



Product Add Right to Left Simple Remainder
(5)

Digit Add Right To Left Simple Remainder

Each character in the scanned data is assigned a numeric value (see *OCR Check Digit Multiplier on page 13-26*). The check digit multiplier is reversed in order. Each value representing a character in the scanned data is multiplied by its corresponding digit in the reversed multiplier, resulting in a product for each character in the scanned data. The sum of each individual digit in all of the products **except for the check digit's product** is then calculated. The check digit passes if this sum modulo Check Digit Modulus is equal to the check digit's product.

Example:

Scanned data numeric value is 122459 (check digit is 6)

Check digit multiplier string is 123456

Digit	1	2	2	4	5	9
Multiplier	6	5	4	3	2	1
Product	6	10	8	12	10	9
Digit add	6+	1+0+	8+	1+2+	1+0=	19 9

The Check Digit Modulus is 10. It passes because 19 divided by 10 leaves a remainder of 9.



Digit Add Right to Left Simple Remainder
(6)

Health Industry - HIBCC43

This is the health industry module 43 check digit standard. The check digit is the modulus 43 sum of all the character values in a given message, and is printed as the last character in a given message.

Example:

Supplier Labeling Data Structure: + A 1 2 3 B J C 5 D 6 E 7 1

Sum of values: $41+10+1+2+3+11+19+12+5+13+6+14+7+1 = 145$

Divide 145 by 43. The quotient is 3 with a remainder of 16. The check digit is the character corresponding to the value of the remainder (see [Table 13-2](#)), which in this example is 16, or **G**. The complete Supplier Labeling Data Structure, including the check digit, therefore is:

A 1 2 3 B J C 5 D 6 E 7 1 G

Table 13-2 *Table of Numeric Value Assignments for Computing HIBC LIC Data Format Check Digit*

0 = 0	9 = 9	I = 18	R = 27	- = 36
1 = 1	A = 10	J = 19	S = 28	. = 37
2 = 2	B = 11	K = 20	T = 29	Space = 38
3 = 3	C = 12	L = 21	U = 30	\$ = 39
4 = 4	D = 13	M = 22	V = 31	/ = 40
5 = 5	E = 14	N = 23	W = 32	+ = 41
6 = 6	F = 15	O = 24	X = 33	% = 42
7 = 7	G = 16	P = 25	Y = 34	
8 = 8	H = 17	Q = 26	Z = 35	



Health Industry - HIBCC43
(9)

Inverse OCR

Parameter # 856

SSI # F2h 58h

Inverse OCR is white or light words on a black or dark background. Select an option for decoding inverse OCR:

- **Regular Only** - Decode regular OCR (black on white) strings only.
- **Inverse Only** - Decode inverse OCR (white on black) strings only.
- **Autodiscriminate** - Decode both regular and inverse OCR strings.

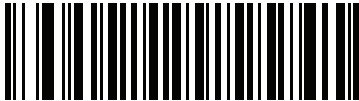

***Regular Only**
(0)

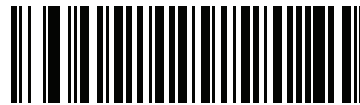

Inverse Only
(1)



Autodiscriminate
(2)

OCR Redundancy

Parameter # 1770

SSI # F8h 06h EAh

This option adjusts the number of times to decode an OCR text string before transmission. There are three levels of OCR decode redundancy. There is an inverse relationship between the redundancy level and OCR decoding aggressiveness. Increasing the level of the redundancy can reduce OCR scanning aggressiveness, so select only the level of redundancy necessary.

- **OCR Redundancy Level 1:** This default setting allows the digital scanner to operate in its most aggressive state while providing sufficient accuracy in decoding most in-spec OCR text strings.
- **OCR Redundancy Level 2:** This setting eliminates most misdecodes while maintaining reasonable aggressiveness.
- **OCR Redundancy Level 3:** Select this option with greater redundancy requirements if OCR Redundancy Level 2 fails to eliminate misdecodes.



***OCR Redundancy Level 1**
(1)



OCR Redundancy Level 2
(2)



OCR Redundancy Level 3
(3)

CHAPTER 14 INTELLIGENT DOCUMENT CAPTURE

Introduction

Intelligent Document Capture (IDC) is Zebra advanced image processing firmware for select imager based scanners. This chapter describes the IDC functionality, provides parameter bar codes to control IDC features, and includes a quick start procedure.

The IDC Process

Intelligent Document Capture:

1. Verifies a bar code is appropriate to use as an IDC anchor or link. See [Bar Code Acceptance Test](#).
2. Determines the rectangular region to capture as an image. See *Capture Region Determination on page 14-2*.
3. Processes the captured image. See *Image Post Processing on page 14-3*.
4. Transmits the data. See *Data Transmission on page 14-3*.

Bar Code Acceptance Test

Upon decoding a bar code, the scanner checks that the bar code fits the description of a bar code that anchors or links to an IDC form. To be accepted as an IDC bar code:

- The symbology must be enabled for decode, and also enabled via *IDC Symbology on page 14-8*. The IDC firmware allows enabling between zero and eight symbologies simultaneously: Code 128, Code 39, Interleaved 2 of 5, Discrete 2 of 5, Codabar, PDF417, Data Matrix, and EAN-128.
- The decoded data must satisfy the values set in the *IDC Minimum Text Length* and *IDC Maximum Text Length* parameters. To disable either of these checks, set the value to zero.

If the bar code does not satisfy both requirements, it is sent as a normal (non-IDC) decode.

An IDC bar code is required when *IDC Operating Mode on page 14-7* is set to **Anchored** or **Linked**.

Free-Form operating mode does not require a bar code, but transmits decoded data if one is found and satisfies the requirements. If no bar code is decoded, the document capture process starts but may require specifying a non-zero value for the *IDC Delay Time on page 14-17*. The scanner must wait for at least this amount of time after trigger pull before capturing a document, unless a bar code is decoded before the time expires.

If *Picklist Mode on page 10-25* is enabled, the bar code must be directly under the aiming pattern and within the scanner's decode range, and the region to capture must be completely within the scanner's field-of-view.

Capture Region Determination

After accepting an IDC bar code, the firmware establishes the region to capture as an image. The method used depends on the setting of the *IDC Operating Mode* as follows.

The IDC firmware emits a single low beep after successfully capturing a region. The scanner is then no longer capturing images and can be moved without disturbing the IDC output. Be sure to hold the trigger button until the decode beep, otherwise the IDC process may be aborted.

IDC Operating Mode = Anchored

A coordinate system is built based on the bar code in its rectified (de-skewed) form. The origin is the center of the bar code, and the x-axis is set toward the right, from the bar code's point of view. The unit module width of the bar code is the unit for x. Similarly, the y-axis is set toward the up direction. The unit for the y-axis is specified via the parameter *IDC Aspect on page 14-11*. This is the aspect ratio of a thin bar or space - the bar code's height is divided by this value to get this unit. Set *IDC Aspect* to zero to automatically calculate the aspect ratio. The bar code can be of different sizes for the same form, as long as the center of the bar code is the same when the bar code's length changes.

From this coordinate system, the IDC area is determined using four parameters: offsets in x and y (*IDC X Coordinate*, *IDC Y Coordinate*) to the region's top-left corner, and width and height (*IDC Width*, *IDC Height*).

If the capture area is relatively large as compared to the bar code area, the calculation to obtain the capture area is prone to significant errors. A recommended solution is to enclose the form with a single black-lined rectangular border (a box), which is not in contact with any other line on the outside of the form (although it can be connected to lines on the inside of the form). When the *IDC Find Box Outline* is set, the firmware searches for the box, and does not decode if any edges are broken (such as by a protruding thumb).

The *IDC Zoom Limit* parameter controls the quality of the captured form. The IDC firmware rejects capturing a form unless the width is at least the *IDC Zoom Limit* percentage of the *IDC Width* parameter. For example, if *IDC Zoom Limit* is set to 100 and *IDC Width* is set to 150, the form must be at least 300 pixels wide before it is captured (each unit module is scaled to two pixels).

The *IDC Maximum Rotation* parameter controls the maximum rotation any edge of the form can have in relation to the scanner's horizontal or vertical axis.

IDC Operating Mode = Free-Form or Linked

The document capture region is a rectangular piece of paper, or a portion of it enclosed by a rectangular border. In either case, all four sides of the capture region must be completely within the scanner's field-of-view, and there must be sufficient contrast at the border of the capture region. For example, if a piece of white paper contains the document to capture, it must be put in front of a dark background.

By default, the scanner captures the largest rectangular region within the field-of-view. To specify a particular border type, use the *IDC Border Type* parameter.

The region must contain at least 10% of the field-of-view in two dimensions.

If an IDC bar code is decoded, IDC uses its location to start the search for the capture region. Otherwise, it searches the capture region from the center of the field-of-view. IDC also uses the orientation of a decoded IDC bar code to orient the output image.

Image Post Processing

After determining the document capture region, the firmware de-skews and re-samples the region as follows. Enabling *IDC Captured Image Brighten* calls normalization, which makes the brightness of the image uniform, and enhances contrast as a large percent of background pixels is made completely white (a smaller percent of pixels is made completely black if the firmware determines there is no danger of enhancing the contrast of a very bland area). Enabling *IDC Captured Image Sharpen* enhances the sharpness of the image.

IDC re-samples the image about one output pixel per input pixel for **Free-Form** or **Linked** modes and two pixels-per-module in **Anchored** mode.

IDC compresses and transmits the image in one of the standard image formats selected by the *IDC File Format Selector*, *IDC Bits Per Pixel*, and *IDC JPEG Quality* parameters.

Note that it may take several seconds for post processing to complete, depending on the size of the captured region, the options enabled, and the scanner model.

Data Transmission

After processing the captured image, IDC assembles the image with the decoded bar code data (if applicable) into an ISO/IEC 15434 style packet and transmits it to the host. The scanner issues the standard decode beep and the trigger can be released. Be sure to set the *USB Device Type on page 5-6* to **Symbol Native API (SNAPI) with Imaging Interface**.

PC Application and Programming Support

For a sample application running on the Microsoft Windows operating system, contact your Zebra representative. This application displays bar code data and/or captured images from Intelligent Document Capture enabled scanners and allows setting and reading IDC parameters. Complete source code and documentation are also provided for developing custom applications. The application includes documentation for the ISO/IEC 15434 format as used by the IDC firmware and C# code to process it.

Setting Parameters

This section describes the parameters controlling the IDC firmware and provides programming bar codes for setting them.

The scanner ships with the settings shown in [Table 14-1 on page 14-5](#) (also see [Appendix A, Standard Parameter Defaults](#) for all defaults). If the default values suit requirements, programming is not necessary.

To set feature values, scan a single bar code or a short bar code sequence. The settings are stored in non-volatile memory and are preserved even when the imager powers down.

✓ **NOTE** Most computer monitors allow scanning bar codes directly on the screen. When scanning from the screen, be sure to set the document magnification to a level where you can see the bar code clearly, and bars and/or spaces do not merge.

To return all features to default values, scan the *Set Factory Defaults* on page 10-5. Throughout the programming bar code menus, asterisks (*) indicate default values.

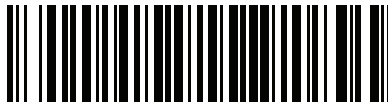

* Indicates default — *Enable Parameter — Feature/option
(1) — Option value

Scanning Sequence Examples

In most cases scanning one bar code sets the parameter value. For example, to set the document capture file format to BMP, scan the **BMP** bar code under *IDC File Format Selector* on page 14-11. The scanner issues a fast warble beep and the LED turns green, signifying a successful parameter entry.

Other parameters require scanning several bar codes. See the parameter descriptions for this procedure.

Errors While Scanning

Unless otherwise specified, to correct an error during a scanning sequence, just re-scan the correct parameter.

Image Document Capture Parameter Defaults

[Table 14-1](#) lists defaults for IDC parameters. Change these values in one of two ways:

- Scan the appropriate bar codes in this chapter. The new value replaces the standard default value in memory. To recall default parameter values, see *Default Parameters on page 10-5*.
- Configure the scanner using the 123Scan configuration program. See [Chapter 2, 123Scan and Software Tools](#).

✓ **NOTE** See [Appendix A, Standard Parameter Defaults](#) for all user preference, host, symbology, and miscellaneous default parameters.

Alternatively, use the sample application to set parameters using the parameter name. The application provides prompts and error checking to assist in setting the parameters correctly and easily. You must use an application to set a parameter to a negative value, as the *IDC X Coordinate* can require.

Table 14-1 *Intelligent Document Capture (IDC) Parameter Defaults*

Parameter	Parameter Name	Parameter Number ¹	SSI Number ²	Default	Page Number
Intelligent Document Capture (IDC) Parameters					
IDC Operating Mode	DocCap_MODE	594	F1h 52h	Off	14-7
IDC Symbology	DocCap_SYMBOLOGY	655	F1h 8Fh	001	14-8
IDC X Coordinate	DocCap_X	596	F4h F1h 54h	-151	14-9
IDC Y Coordinate	DocCap_Y	597	F4h F1h 55h	-050	14-9
IDC Width	DocCap_WIDTH	598	F1h 56h	0300	14-10
IDC Height	DocCap_HEIGHT	599	F1h 57h	0050	14-10
IDC Aspect	DocCap_ASPECT	595	F1h 53h	000	14-11
IDC File Format Selector	DocCap_FMT	601	F1h 59h	JPEG	14-11
IDC Bits Per Pixel	DocCap_BPP	602	F1h 5Ah	8 BPP	14-12
IDC JPEG Quality	DocCap_JPEG_Qual	603	F1h 5Bh	065	14-12
IDC Find Box Outline	Sig_FINDBOX	727	F1h D7h	Disable	14-13
IDC Minimum Text Length	DocCap_MIN_TEXT	656	F1h 90h	00	14-13
IDC Maximum Text Length	DocCap_MAX_TEXT	657	F1h 91h	00	14-14
IDC Captured Image Brighten	Sig_BRIGHTEN	654	F1h 8Eh	Enable	14-14
IDC Captured Image Sharpen	Sig_SHARPEN	658	F1h 92h	Enable	14-15
IDC Border Type	DocCap_BORDER	829	F2h 3Dh	None	14-16

1. Parameter number decimal values are used for programming via RSM commands.
2. SSI number hex values are used for programming via SSI commands.

Table 14-1 *Intelligent Document Capture (IDC) Parameter Defaults (Continued)*

Parameter	Parameter Name	Parameter Number ¹	SSI Number ²	Default	Page Number
IDC Delay Time	DocCap_DELAY	830	F2h 3Eh	000	14-17
IDC Zoom Limit	Sig_MIN_PERCENT	651	F1h 8Bh	000	14-17
IDC Maximum Rotation	Sig_MAX_ROT	652	F1h 8Ch	00	14-18

1. Parameter number decimal values are used for programming via RSM commands.
2. SSI number hex values are used for programming via SSI commands.

IDC Operating Mode

Parameter Name: DocCap_MODE

Parameter # 594

SSI # F1h 52h

Select the operating mode of the Intelligent Document Capture firmware:

- **Off** - Disables the IDC feature.
- **Anchored** - Requires a bar code decode. The image capture region is based off this bar code.
- **Free-Form** - A printed border or page edge defines the image capture region. A bar code is optional.
- **Linked** - A printed border or page edge defines the image capture region. A bar code is required.

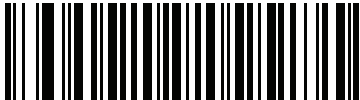

*Off
(0)

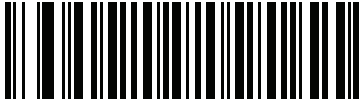

Anchored
(1)

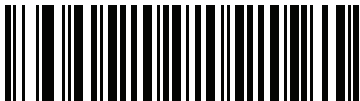

Free-Form
(2)

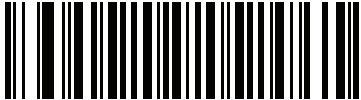

Linked
(3)

IDC Symbology

Parameter Name: DocCap_SYMBOLOGY

Parameter # 655

SSI # F1h 8Fh

Select the bar code type(s) to use when Document Capture mode is not set to **Off**. To enable more than one symbology at a time, simply add the values together. For example, to enable PDF417, Data Matrix, and Code 39 write a value of 98 (32 + 64 + 2).

Scan the following bar code, and then scan three bar codes from [Appendix B, Numeric Bar Codes](#) in the range of 001 to 511 decimal. The default is 001.

Table 14-2 *IDC Symbologies*

Symbology	Value (Decimal)
Code 128	1
Code 39	2
I 2 of 5	4
D 2 of 5	8
Codabar	16
PD 417	32
Data Matrix	64
EAN 128	128
Aztec	256



IDC Symbology

IDC X Coordinate

Parameter Name: DocCap_X

Parameter # 596

SSI # F4h F1h 54h

This parameter only applies when *IDC Operating Mode* is set to **Anchored**. Specify the horizontal offset to the top left corner of the region to capture relative to the center of the bar code. Negative values move toward the left.

Scan the following bar code, and then scan four bar codes from [Appendix B, Numeric Bar Codes](#) in the range of +/- 1279. The default is -151. Note that you must use an application to set a negative value.



IDC X Coordinate

IDC Y Coordinate

Parameter Name: DocCap_Y

Parameter # 597

SSI # F4h F1h 55h

This parameter only applies when *IDC Operating Mode* is set to **Anchored**. Specify the vertical offset to the top left corner of the region to capture relative to the center of the bar code. Negative values move toward the top.

Scan the following bar code, and then scan four bar codes from [Appendix B, Numeric Bar Codes](#) in the range of +/- 1023. The default is -050. Note that you must use an application to set a negative value.



IDC Y Coordinate

IDC Width

Parameter Name: DocCap_WIDTH

Parameter # 598

SSI # F1h 56h

This parameter only applies when *IDC Operating Mode* is set to **Anchored**. Specify the width of the region to capture.

Scan the following bar code, and then scan four bar codes from [Appendix B, Numeric Bar Codes](#) in the range of 0000 to 1279. The default is 0300.



IDC Width

IDC Height

Parameter Name: DocCap_HEIGHT

Parameter # 599

SSI # F1h 57h

This parameter only applies when *IDC Operating Mode* is set to **Anchored**. Specify the height of the region to capture.

Scan the following bar code, and then scan four bar codes from [Appendix B, Numeric Bar Codes](#) in the range of 0000 to 1279. The default is 0050.



IDC Height

IDC Aspect

Parameter Name: DocCap_ASPECT

Parameter # 595

SSI # F1h 53h

This parameter only applies when *IDC Operating Mode* is set to **Anchored**. Specify the bar code's aspect ratio of a thin bar or space. The bar code's height is divided by this value to obtain the unit in the y-axis. Set this parameter to zero to calculate the aspect value automatically.

Scan the following bar code, and then scan three bar codes from [Appendix B, Numeric Bar Codes](#) in the range of 000 to 255. The default is 000.



IDC Aspect

IDC File Format Selector

Parameter Name: DocCap_FMT

Parameter # 601

SSI # F1h 59h

Select a document capture file format appropriate for your system (BMP, TIFF, or JPEG). The scanner stores captured areas in the selected format.



***JPEG
(1)**



**BMP
(3)**



**TIFF
(4)**

IDC Bits Per Pixel

Parameter Name: DocCap_BPP

Parameter # 602

SSI # F1h 5Ah

Select the number of significant bits per pixel (BPP) to use when capturing an image. Select 1 BPP for a black and white image, 4 BPP to assign 1 of 16 levels of grey to each pixel, or 8 BPP to assign 1 of 256 levels of grey to each pixel.



NOTE The scanner ignores these settings for JPEG file formats, which only support 8 BPP.



1 BPP
(0)



4 BPP
(1)



*8 BPP
(2)

IDC JPEG Quality

Parameter Name: DocCap_JPEG_Qual

Parameter # 603

SSI # F1h 5Bh

Set the amount of JPEG compression to perform on the captured image. Higher numbers produce a better quality image but larger files.

Scan the following bar code, and then scan three bar codes from [Appendix B, Numeric Bar Codes](#) in the range of 005 to 100 decimal. The default is 065.



IDC JPEG Quality

IDC Find Box Outline

Parameter Name: Sig_FINDBOX

Parameter # 727

SSI # F1h D7h

This parameter only applies when *IDC Operating Mode* is set to **Anchored**. Scan **Enable Find Box Outline** to search for a rectangular border during document capture.



**Enable Find Box Outline
(1)**

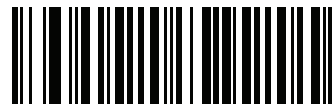

***Disable Find Box Outline
(0)**

IDC Minimum Text Length

Parameter Name: DocCap_MIN_TEXT

Parameter # 656

SSI # F1h 90h

Specify the minimum number of characters encoded in a bar code for the IDC firmware to use it as an anchored or linked bar code. Set this to zero (the default) to disable all checking and use all bar codes.

Scan the following bar code, and then scan two bar codes from [Appendix B, Numeric Bar Codes](#) in the range of 00 to 55 decimal. The default is 00.



IDC Minimum Text Length

IDC Maximum Text Length

Parameter Name: DocCap_MAX_TEXT

Parameter # 657

SSI # F1h 91h

Specify the maximum number of characters encoded in a bar code for the IDC firmware to use it as an anchored or linked bar code. Set this to zero (the default) to disable all checking and use all bar codes.

Scan the following bar code, and then scan two bar codes from [Appendix B, Numeric Bar Codes](#) in the range of 00 to 55 decimal. The default is 00.



IDC Maximum Text Length

IDC Captured Image Brighten

Parameter Name: Sig_BRIGHTEN

Parameter # 654

SSI # F1h 8Eh

Enable **Captured Image Brighten** to make image brightness uniform and enhance contrast such that a large percent of the background pixels is made completely white (a smaller percent of pixels is made completely black if the program determines there is no danger of enhancing the contrast of a very bland area).

✓ **NOTE** This parameter is also used for Signature Capture.

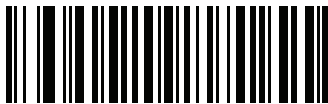

*Enable Captured Image Brighten
(1)



Disable Captured Image Brighten
(0)

IDC Captured Image Sharpen

Parameter Name: Sig_SHARPEN

Parameter # 658

SSI # F1h 92h

Enable this to enhance the sharpness of the image.

✓ **NOTE** This parameter is also used for Signature Capture.



***Enable Captured Image Sharpen
(1)**



**Disable Captured Image Sharpen
(0)**

IDC Border Type

Parameter Name: DocCap_BORDER

Parameter # 829

SSI # F2h 3Dh

This parameter only applies when *IDC Operating Mode* is set to **Free-Form** or **Linked**. Select the style of border used to determine the outline of the capture region:

- **None** - Capture the largest rectangular region within the field-of-view.
- **Black** - The border must be black (such as a printed rectangular border).
- **White** - The border must be white (e.g., paper edge on a dark background).
- **Advanced Edge Detection (AED)** - Capture a region defined by edges of any color and potentially broken.



*None
(0)



Black
(1)



White
(2)



Advanced Edge Detection (AED)
(3)

IDC Delay Time

Parameter Name: DocCap_DELAY

Parameter # 830

SSI # F2h 3Eh

This parameter only applies when *IDC Operating Mode* is set to **Free-Form**. Set the delay for capturing a document after a trigger pull. Decoding a bar code aborts this delay.

Scan the following bar code, and then scan three bar codes from [Appendix B, Numeric Bar Codes](#) in the range of 000 to 200 decimal in units of 10 msec. The default is 000.



IDC Delay Time

IDC Zoom Limit

Parameter Name: Sig_MIN_PERCENT

Parameter # 651

SSI # F1h 8Bh

This parameter only applies when *IDC Operating Mode* is set to **Anchored**. Set the minimal "zoom" percentage value of a form for it to be considered for capture. This controls the quality of the captured form. The IDC firmware rejects capturing a form unless the width is at least the *IDC Zoom Limit* percentage of the *IDC Width* parameter. For example, if you set this parameter to 100 and *IDC Width* to 150, the form must be at least 300 pixels wide before it is captured (each unit module is scaled to two pixels).

Set this to zero (the default) to disable all checking.

Scan the following bar code, and then scan three bar codes from [Appendix B, Numeric Bar Codes](#) in the range of 000 to 100 percent. The default is 000.

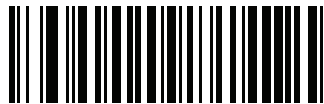

IDC Zoom Limit

IDC Maximum Rotation

Parameter Name: Sig_MAX_ROT

Parameter # 652

SSI # F1h 8Ch

This parameter only applies when *IDC Operating Mode* is set to **Anchored**. Set the maximum rotation any edge of the form can have in relation to the scanner's horizontal or vertical axis for it to be considered for capture. Set this to zero (the default) to disable all checking.

Scan the following bar code, and then scan two bar codes from [Appendix B, Numeric Bar Codes](#) in the range of 00 to 45 decimal. The default is 00.



IDC Maximum Rotation

Quick Start

This section familiarizes you with some of the Intelligent Document Capture features. *IDC Demonstrations on page 14-20* includes instructions to demonstrate the Anchored, Free-Form, and Linked modes using a sample form to provide an understanding of how to use IDC. These examples do not illustrate all capabilities of the advanced IDC firmware. Build upon these using different parameter settings and forms.

Sample IDC Setup

To set up IDC:

1. Connect a scanner equipped with IDC to the host computer's USB port.
2. To set the scanner to the default settings and proper USB host type, scan **Set Defaults** followed by the **Symbol Native API (SNAPI) with Imaging Interface** bar code. Allow time for the scanner to reset and the USB connection to remunerate after each scan before continuing.



Set Defaults



Symbol Native API (SNAPI) with Imaging Interface

3. Start the sample application and select the scanner in the **SNAPI Scanners** drop-down menu.
4. Set parameters as specified in *IDC Demonstrations on page 14-20* using the sample application or by scanning parameter bar codes in this guide. The bar code in the sample form is Code 128, which is enabled by default for decoding and as a Document Capture symbology. You can change these settings for your IDC application.
5. Perform each demo. When scanning, aim the scanner at the bar code in the center of the rectangle. Pull the scanner back so the rectangle is fully contained in the aiming pattern. When you pull the trigger, the scanner emits a low tone to indicate that the IDC firmware identified and captured an image, then a decode beep to indicate that the data transmitted. There may be several seconds between the two beeps, depending on the size of the captured image and options selected (de-skew, brighten, etc). You can move the scanner after the first beep, but continue the hold the trigger or the scanner may end the session before sending the data.

IDC Demonstrations

Anchored Mode Demo

- Set *IDC Operating Mode* on page 14-7 to **Anchored**.
- Set parameters to these values:
 - Set *IDC Height* on page 14-10 to **100**.
 - Set *IDC Width* on page 14-10 to **90**.
 - Set *IDC X Coordinate* on page 14-9 to **-175**.
 - Set *IDC Y Coordinate* on page 14-9 to **-50**.
- Pull the trigger. The scanner decodes the bar code and captures an image of the text scroll.
- Rotate the form clockwise so the word **Capture** is along the bottom edge, and pull the trigger. The scanner decodes the bar code and captures the same image, including orientation. (This example also works with the form rotated counter-clockwise or upside down).
- Modify the values for height, width, x, and y. Pull the trigger. The captured area changes in size and location.
- Cover the bar code with a small piece of paper (or your finger) and pull the trigger. The scanner does not decode the bar code or capture an image.

What This Demonstrates

Anchored mode captures an image of fixed size and location relative to a bar code on the page. Parameters control the height, width, and location. The IDC firmware requires that a bar code is present in order to capture an image. It decodes the bar code and uses it to adjust the image to the upright orientation.

Free-Form Mode Demo

- Set *IDC Operating Mode* on page 14-7 to **Free-Form**.
- Pull the trigger. The scanner decodes the bar code and captures an image of the entire rectangle, including the contents.
- Modify the values for height, width, x, and y. Pull the trigger. Note that the captured image is not affected.
- Rotate the form clockwise so the word **Capture** is along the bottom edge, and pull the trigger. The scanner decodes the bar code and captures the same image, including orientation. (This example also works with the form rotated counterclockwise or upside down).
- Cover the bar code with a small piece of paper and pull the trigger. The scanner does not decode the bar code and does not re-orient the captured image to the normal position, i.e., with the logo in the upper-left corner.

What This Demonstrates

Free-Form mode captures an image where a rectangular border on the page determines the size and position. It adjusts the image to the upright orientation if a bar code is found and decoded in the image.

Linked Mode Demo

Set IDC Operating Mode on page 14-7 to **Linked**.

Use the examples from the [Free-Form Mode Demo](#), noting that the last item (covering the bar code) does not decode the bar code or capture an image.

What This Demonstrates

Linked mode captures an image where a rectangular border on the page determines the size and position. The IDC firmware requires that a bar code is present in order to capture an image. It decodes the bar code and uses it to adjust the image to the upright orientation.

Other Suggestions

Hold the scanner at an angle (up/down or side to side) to the page instead of perpendicular to it. The IDC firmware de-skews and adjusts the brightness (enabled by default) to produce a quality image when the scanner is held at less than ideal conditions.

Quick Start Form

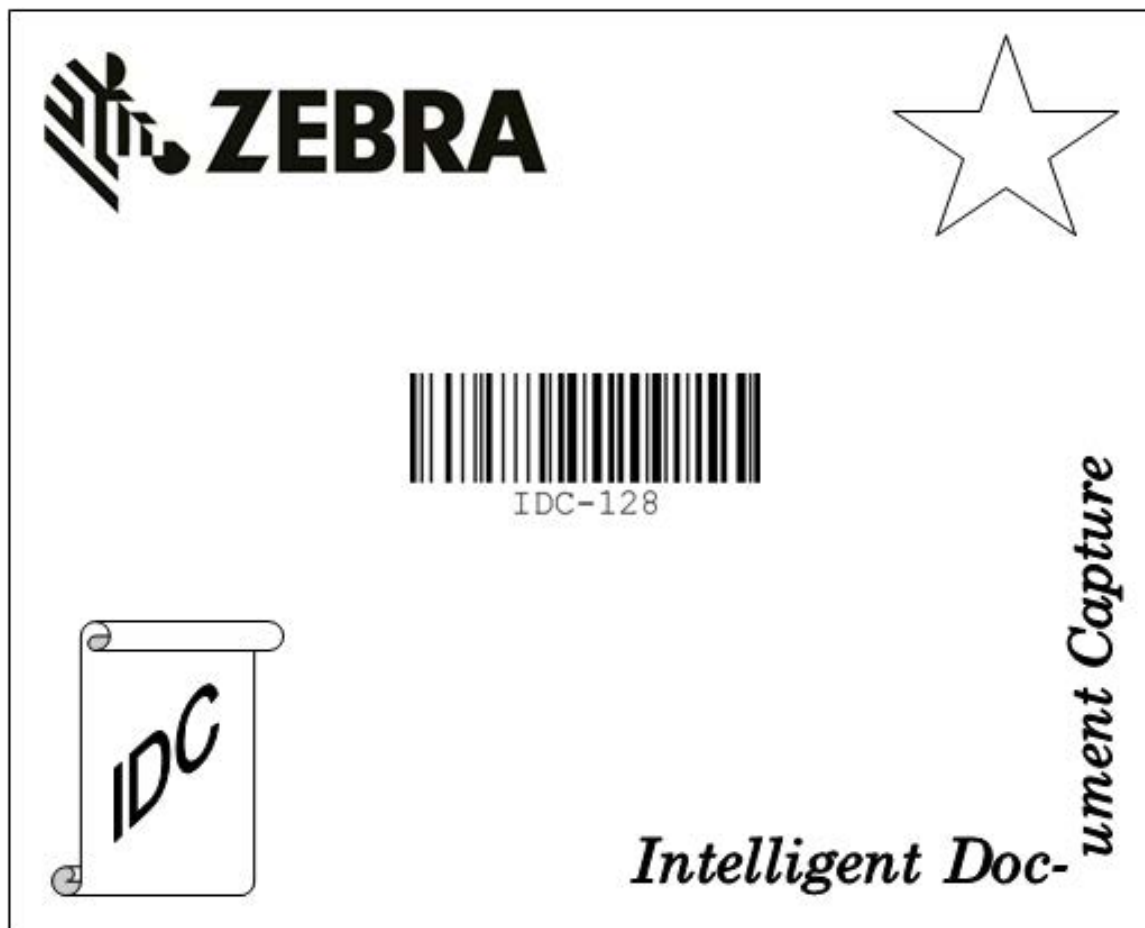

Figure 14-1 Quick Start Form

CHAPTER 15 DIGIMARC BAR CODE

Introduction

Digimarc Barcode is a machine-readable code that is invisible to people.

Digimarc Symbology Selection

Digimarc codes are reported as UPC-A, UPC-E, EAN-13 or GS1 DataBar Expanded.

✓ **NOTE** Conversion of the Digimarc reported code types to other bar code types is not supported.

AIM and Symbol code IDs are supported for the reported Digimarc code types.

Picklist

The Digimarc decoder searches configured block areas of the image for Digimarc codes. The Digimarc decoder works the same whether or not Picklist is enabled or disabled.

✓ **NOTE** Decode time could be greater given the extra processing done by system and decoder when in Picklist mode.

Digimarc Digital Watermarks

Parameter # 1687

SSI # F8h 06h 97h

To enable or disable the Digimarc Digital Watermarks code scan the appropriate barcode below.

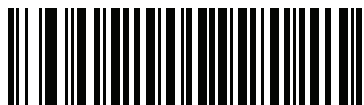

**Enable Digimarc Digital Watermarks/DW
(1)**



***Disable Digimarc Digital Watermarks/DW
(0)**

CHAPTER 16 DATA FORMATTING: ADF, MDF, PREFERRED SYMBOL, DATA PARSING

Introduction

This chapter briefly describes the Zebra features available for customizing scanner operation.

Advanced Data Formatting (ADF)

Advanced Data Formatting (ADF) is a means of customizing data from before transmission to the host device. Use ADF to edit scan data to suit your host application's requirements. With ADF you scan one bar code per trigger pull. ADF is programmed using 123Scan.

To watch a video on Creating an Advanced Data Formatting (ADF) Rule using 123Scan, go to: zebra.com/ScannerHowToVideos.

For additional information, refer to the Advanced Data Formatting Programmer Guide.

Multicode Data Formatting (MDF)

Multicode Data Formatting (MDF) enables a 2D imaging scanner to scan all barcodes on a label with a single trigger pull, and then modify and transmit the data to meet host application requirements. MDF supports programming up to nine unique labels into one scanner. MDF also supports scanning multiple barcodes on opposite sides of a box by holding the trigger.



NOTE MDF works if each barcode contains one data field (one piece of information), MDF does not support barcodes contains multiple data fields within each barcode. If multiple data fields are contained within a barcode, see the Data Parsing section of this chapter.

Programming options include:

- Output all or specific bar codes.
- Control the bar code output sequence.
- Apply unique multicode data formatting (MDF) to each output bar code.
- Discard scanned data if all required bar codes are not present.

For more information, refer to the guide Multicode Data Formatting and Preferred Symbol, p/n MN-002895-xx.

To watch a video on Creating an Multicode Data Formatting (MDF) Rule using 123Scan, go to: zebra.com/ScannerHowToVideos.

MDF in Hands-Free Mode

MDF in a hands-free scanning mode may yield multiple unexpected and undesired outputs when a label (most likely on a complex label) passes through the scanner's field of view. This problem happens when the complex label's barcodes can be matched by more than one group (for example, Group 1 represents all barcodes present and Group 2 represent some barcodes present).

- ✓ **NOTE** A similar problem can also occur in the hand-held trigger mode. If multiple MDF rules/groups exist and all the label is not in the field of view when pressing the trigger, the output may vary depending on which MDF rules/groups match.

The problem is demonstrated in *Figure 16-1* and as follows:

1. As the label is moving through the field of view, it is first partially read (some of the barcodes in the field of view in Frame 2).
2. Then, the second decode occurs as it is fully read (all the barcodes in the field of view in Frame 3).
3. This yields two different outputs (instead of the expected single output) from the presentation of a label. This problem is driven by a complex label inadvertently matching two different MDF rules/groups, thereby yielding two outputs.

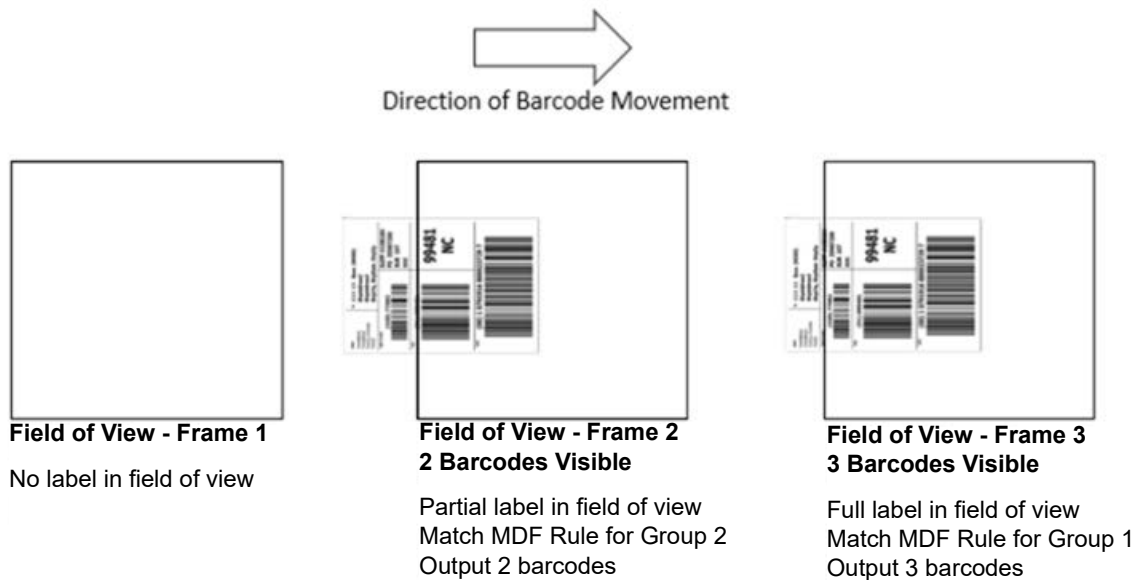

Figure 16-1 Scanning Label in a Horizontal Orientation

- ✓ **NOTE** To minimize issues associated with MDF hands-free mode, see *MDF Best Practices* on page 16-3.

MDF Best Practices

Suggestions to minimize the undesired multiple outputs during the MDF scanning in hands-free mode are as follows:

- Scan barcodes in a vertical orientation (see [Figure 16-2](#)).

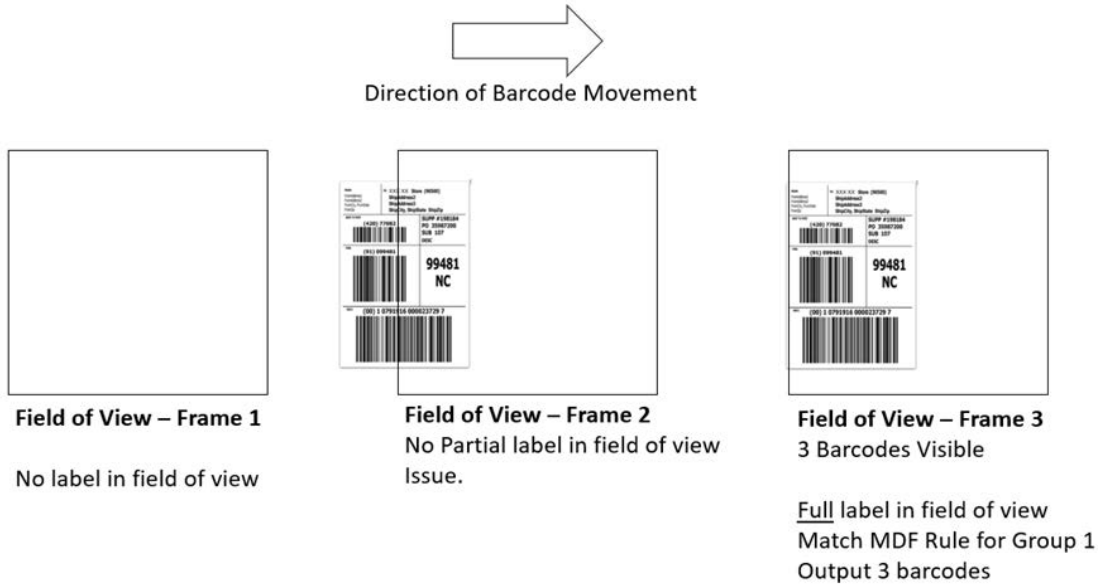

Figure 16-2 Scanning Label in a Vertical Orientation

- When creating the MDF programming with multiple groups, the Group 1's pattern match should be the most complicated (hardest to match), which equals to the most number of barcodes and criteria. Then Group 2, 3, and so on should be progressively matched more easily.
- When defining criteria, avoid enabling an output when the pattern is not matched. Set **Output if NO pattern match set as Discard bar code** (see [Figure 16-3](#)).

Pattern Match

A pattern match is the criteria used to determine if a set of scanned bar codes qualify for manipulation with Multicode Data Formatting.
 If the pattern match criteria are met, the MDF will be applied to the output of "Output if pattern match".
 If the pattern match criteria are not met, the MDF will be applied to the output of "Output if NO pattern match".

Is bar code required for pattern match [What is this?](#)

Required for match
 Not part of match

Output if pattern match.
 [What is this?](#)

Output if NO pattern match.
 [What is this?](#)

Discard bar code

Figure 16-3 Figure Match Setting for Output

- Select **Discard barcode(s) NOT within the pattern match** in the 123Scan MDF setting. For more details, select **What is this?** located next to this selection.

Discard scanned bar code(s) NOT within pattern match [What is this?](#)

- To prevent double decodes of the same symbol, increase the **Timeout Between Same Symbols** setting. See *Timeout Between Decodes, Same Symbol on page 10-28* for more details.
- Turn the scanner's aimer on to assist operators in scanning the barcode in a more consistent manner.
- Other reasons a label/barcode may not be decoded while in the field of view are as follows:
 - The label out of focus (too close or too far away). See *Decode Ranges on page 3-9* for correct working range.
 - Specular reflection (reflection off a shiny surface).
 - The label is presented at extreme angle to scanner.

Preferred Symbol

Preferred Symbol is a bar code prioritization technique that enables favored decoding of a high priority bar code(s). The Preferred Symbol is the only bar code that is decoded and output within the preset Preferred Symbol Timeout. During this time, the scanner attempts to decode the prioritized bar code and reports only this bar code.

For more information, refer to the guide Multicode Data Formatting and Preferred Symbol, p/n MN-002895-xx.

To program Preferred Symbol via 123Scan, select 123Scan > Configuration Wizard > Symbologies screen, and then select Preferred Symbol from the drop-down menu. Below are the Preferred Symbol programming options within 123Scan.

Preferred Symbol

Preferred Symbol [What is this?](#)

Options

Prioritized symbologies

Preferred Symbol Options [Edit](#)

Identify exact bar code

Preferred symbol criteria [View / Edit](#)

Prioritization time (ms) [What is this?](#)

Data Parsing (UDI Scan+, Label Parse+ and Blood Bag Parse+)

Data Parsing allows a Zebra scanner to scan a UDI label, GS1 label, or Blood Bags with one or more barcodes encoded with multiple data fields (such as date of manufacture, expiration date, batch number, GTIN, and SSCC) and transmit select data fields and not others, in a specific order to a host application. Simply wave the scanner over all the barcodes while holding the trigger and the scanner takes care of the rest.

The scanner finds and transmits only the required data fields, even if they are spread across multiple barcodes and on different sides of the container. In addition, the scanner can insert field separators (such as tab, enter, and slash) to automate data entry into a host application.

Programming your scanner is easy using 123Scan's intuitive drag and drop interface. For more information on writing a Data Parsing Rule, refer to the Data Parsing (UDI, GS1 Label, Blood Bag) on Zebra Scanners User Guide available at: zebra.com/support.

To watch a video on Creating a Data Parsing Rule using 123Scan, go to: zebra.com/ScannerHowToVideos.

Scan a UDI Label using UDI Scan+

Government regulatory agencies ¹ have established Unique Device Identification (UDI) standards to identify and monitor the distribution and use of medical devices within healthcare environments. These UDI standards identify medical devices from manufacturing through distribution to patient use - enabling complete traceability of the millions of individual medical devices utilized for patient care. To enable UDI compliance, all medical devices must carry a UDI label to enable "track and trace" from the point of production, during shipment, through the product's use and disposal.

✓ **NOTE:** ¹ United States Food and Drug Administration (FDA), European Commission, International Medical Device Regulatory Forum.

Scan a GS1 Label using Label Parse+

The GS1 Organization, an international standards body, has released specifications used worldwide for generating shipping labels. These labels are used when shipping packages (logistics), raw materials and produce.

Scan a Blood Bag Label using Blood Bag Parse+

The ICCBBA Organization, an international standards body, has released a specification used worldwide for generating blood bag labels. These labels are used when shipping, storing and using blood bags. For more information, go to: icbba.org/tech-library/icbba-documents/standards-documents/standard-labeling-blood2.

CHAPTER 17 DRIVER'S LICENSE SET UP (DS8108-DL)

Introduction

The scanner uses internally embedded algorithms to parse out bar code information from standard US driver's licenses and certain other American Association of Motor Vehicle Administrators (AAMVA) compliant ID cards. Scanning these bar codes produces formatted data for use in age verification, credit card application information, and more.

This chapter describes how to program the scanner to read and use the data contained in the 2D bar codes on US driver's licenses and AAMVA compliant ID cards.

Table 17-1 *DL Parsing Parameter Table*

Parameter	Default	Page Number
DL Parsing Parameters		
Driver's License Parsing	No Driver's License Parsing	17-2
Parsing Driver's License Data Fields	N/A	17-3
Driver's License Parse Field Bar Codes	N/A	17-4
AAMVA Parse Field Bar Codes	N/A	17-7
Set Default Parameter	N/A	17-17
Output Gender as M or F	N/A	17-17
Date Format	CCYYMMDD	17-18
No Separator	N/A	17-19
Send Keystroke	N/A	17-20
Control Characters		17-20
Keyboard Characters		17-24
Parsing Rule Example	N/A	17-39
Embedded Driver's License Parsing ADF Example	N/A	17-43

Driver's License Parsing

Parameter # 645

SSI # F1 85

To enable driver's license parsing on the scanner, scan the **Embedded Driver's License Parsing** bar code. This does not require Zebra software (.DLL).

Scan the bar codes on the following pages in the order indicating the sequence of data fields that the scanner outputs. See *Parsing Driver's License Data Fields (Embedded Driver's License Parsing)* on page 17-3 for more information.



***No Driver's License Parsing**

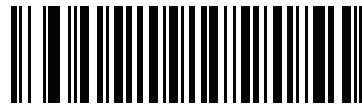

Embedded Driver's License Parsing

Parsing Driver's License Data Fields (Embedded Driver's License Parsing)

To program a parsing rule:

1. Scan *Begin New Driver's License Parse Rule* on page 17-4.
2. Scan any of the field bar codes on the following pages, or **Send Keystroke (Control Characters and Keyboard Characters)** on page 17-20.
3. After entering the entire rule, scan *Save Driver's License Parse Rule* on page 17-4 to save the rule.

✓ **NOTE** The scanner stores only one driver's license parsing rule in memory at a time. Saving a new rule replaces the prior rule.

To abort the programming sequence at any time during programming, scan *Quit Entering Driver's License Rule* on page 17-4. Any previously saved rule is retained.

To erase a saved rule, scan *Erase Driver's License Parse Rules* on page 17-4.

Embedded Driver's License Parsing Criteria - Code Type

After specifying the fields and their order for the parsed driver's license, you can also apply standard ADF rules to the parsed data using the **Parsed Driver's License** criterion bar code in the *Advanced Data Formatting Programmer Guide*.

✓ **NOTE** Only create standard ADF rules on parsed driver's license data when configured for Embedded Driver's License Parsing.

See *Embedded Driver's License Parsing ADF Example* on page 17-43 for a sample ADF rule using this code type criterion.

Driver's License Parse Field Bar Codes



Begin New Driver's License Parse Rule



Save Driver's License Parse Rule



Quit Entering Driver's License Rule



Erase Driver's License Parse Rules

Driver's License Parse Field Bar Codes (continued)

The supported parse fields begin below. Not all IDs present data in the same format. For example, some IDs can have separate fields for first name, last name, and middle initial, while others have a single field with the entire name. Also, some IDs expire on the subject's birth date while the expiration date field only indicates the year. To present data in a consistent format, use the following nine bar codes to return data calculated from the actual data contained in the ID bar code.



First Name



Middle Name/Initial

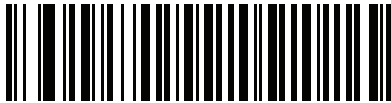

Last Name

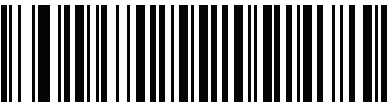

Name Suffix



Name Prefix



Expiration Date



Birth Date

Driver's License Parse Field Bar Codes (continued)



Issue Date



ID Number (Formatted)

AAMVA Parse Field Bar Codes

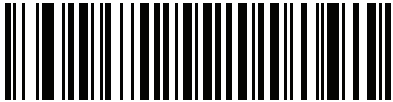

AAMVA Issuer ID



Full Name



Last Name



First Name

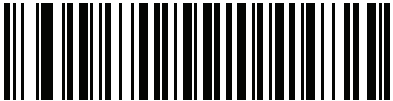

Middle Name / Initial



Name Suffix

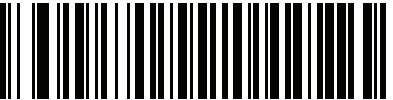

Name Prefix

AAMVA Parse Field Bar Codes (continued)



Mailing Address Line 1

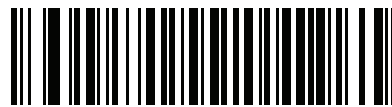

Mailing Address Line 2



Mailing Address City

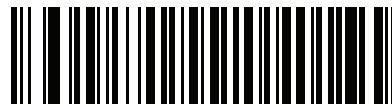

Mailing Address State



Mailing Address Postal Code

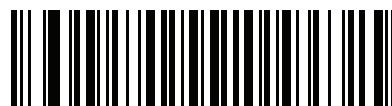

Home Address Line 1



Home Address Line 2

AAMVA Parse Field Bar Codes (continued)

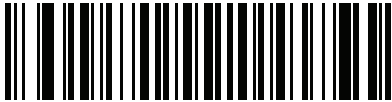

Home Address City



Home Address State

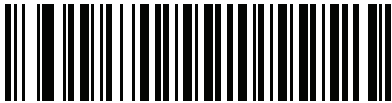

Home Address Postal Code

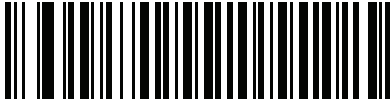

License ID Number

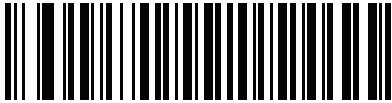

License Class

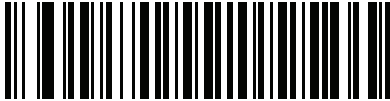

License Restrictions

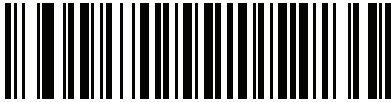

License Endorsements

AAMVA Parse Field Bar Codes (continued)



Height (Feet and/or Inches)

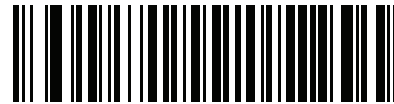

Height (Centimeters)

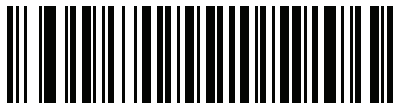

Weight (Pounds)



Weight (Kilograms)



Eye Color



Hair Color



License Expiration Date

AAMVA Parse Field Bar Codes (continued)

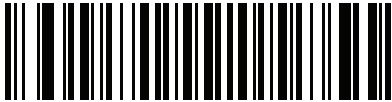

Birth Date

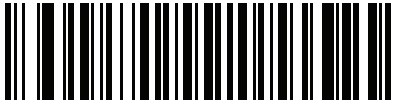

Gender

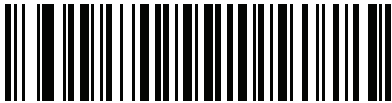

License Issue Date

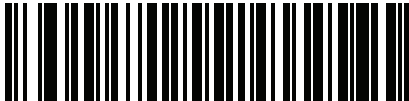

License Issue State

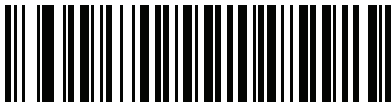

Social Security Number

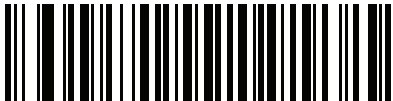

Permit Class

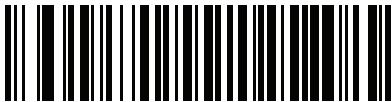

Permit Expiration Date

AAMVA Parse Field Bar Codes (continued)



Permit ID Number

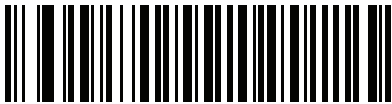

Permit Issue Date

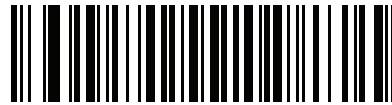

Permit Restrictions

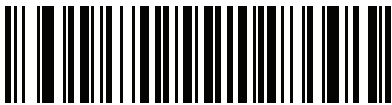

Permit Endorsements



AKA Social Security Name



AKA Full Name

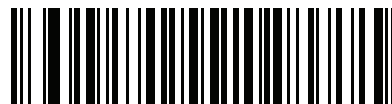

AKA Last Name



AKA First Name

AAMVA Parse Field Bar Codes (continued)

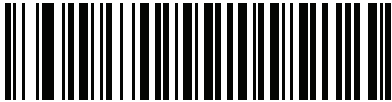

AKA Middle Name / Initial



AKA Name Suffix

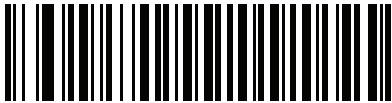

AKA Name Prefix



AKA Birth Date

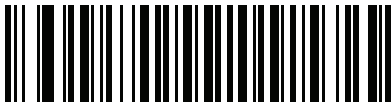

Issue Timestamp



Number of Duplicates



Medical Codes

AAMVA Parse Field Bar Codes (continued)



Organ Donor

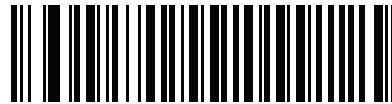

Nonresident

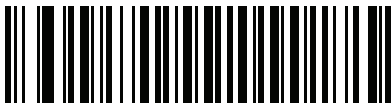

Customer ID



Weight Range

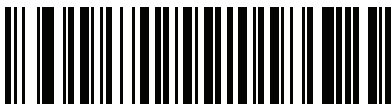

Document Discriminator



Country



Federal Commission Codes

AAMVA Parse Field Bar Codes (continued)

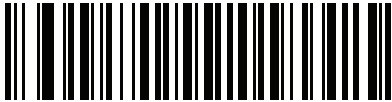

Place of Birth



Audit Information

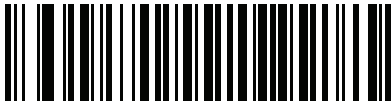

Inventory Control



Race / Ethnicity

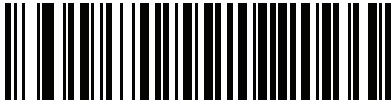

Std Vehicle Class



Std Endorsements

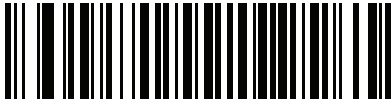

Std Restrictions

AAMVA Parse Field Bar Codes (continued)

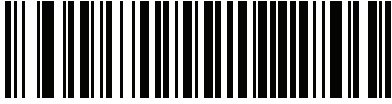

Class Description

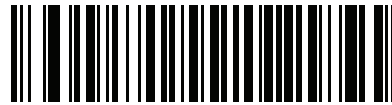

Endorsement Description

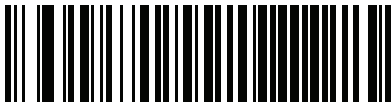

Restrictions Description

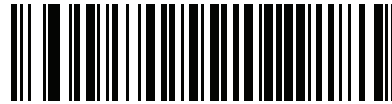

Height in Inches

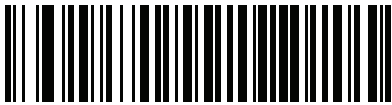

Height in Centimeters

Parser Version ID Bar Code

Include this field to emit embedded parser software version identification



Parser Version ID

User Preferences

Set Default Parameter

Scan this bar code to return all parameters to the default values listed in [Table A on page A-1](#).

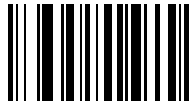

*Set All Defaults

Output Gender as M or F

Scan this bar code to report the gender as **M** or **F** instead of a numeric value.

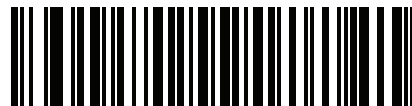

Output gender as M or F

Date Format

Use these bar codes to select the date format to display. Date fields include the following:

- **CCYY** = 4-digit year (**CC**=2-digit century [00-99], **YY**=2-digit year in the century [00-99])
- **MM** = 2-digit month [01-12]
- **DD** = 2-digit day of the month [00-31]

The default is **CCYYMMDD**.

✓ **NOTE** To specify a date separator, i.e., a character separating each field of the date, scan the **Send <character>** bar code that corresponds to the alphanumeric character to use as the date separator immediately following the date format bar code. To select no date separator, scan the **No Separator** DL parsing rule immediately following the date format bar code.

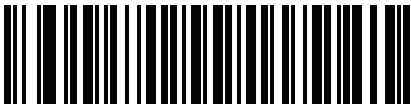

*CCYYMMDD

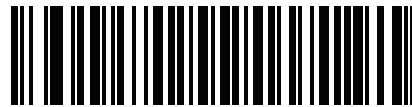

CCYYDDMM

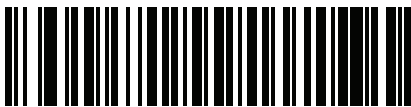

MMDDCCYY

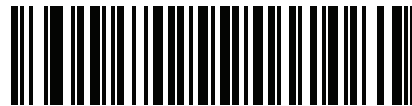

MMCCYYDD

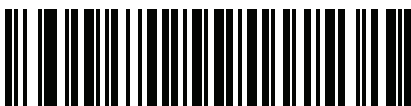

DDMMCCYY

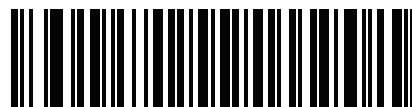

DDCCYYMM

Date Format (continued)

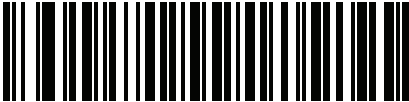

YYMMDD



YYDDMM

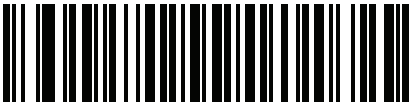

MMDDYY



MMYYDD

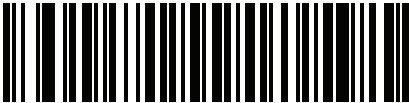

DDMMYY



DDYYMM

No Separator

Scan this bar code immediately following a date format bar code to use no separator character between the date fields.



No Separator

Send Keystroke (Control Characters and Keyboard Characters)

Control Characters

Scan a **Send** bar code for the keystroke to send.



Send Control B



Send Control D



Send Control F



Send Control H



Send Control A



Send Control C



Send Control E



Send Control G

Control Characters (continued)



Send Control I



Send Control J



Send Control K



Send Control L



Send Control M



Send Control N



Send Control O



Send Control P

Control Characters (continued)



Send Control Q



Send Control R



Send Control S



Send Control T



Send Control U



Send Control V



Send Control W

Control Characters (continued)



Send Control X



Send Control Y



Send Control Z



Send Control [



**Send Control **



Send Control]

Control Characters (continued)



Send Control 6



Send Control -

Keyboard Characters

Scan a **Send** bar code for the keyboard characters to send.



Send Space



Send !



Keyboard Characters (continued)



Send \$



Send %



Send &



Send '



Send (/



Send)



Send *

Keyboard Characters (continued)



Send +



Send ,



Send -



Send .



Send /



Send 0



Send 1

Keyboard Characters (continued)



Send 2



Send 3



Send 4



Send 5



Send 6



Send 7



Send 8

Keyboard Characters (continued)



Send 9



Send :



Send ;



Send <



Send =



Send >



Send ?

Keyboard Characters (continued)



Send @



Send A



Send B



Send C



Send D



Send E



Send F

Keyboard Characters (continued)



Send G



Send H



Send I



Send J



Send K



Send L



Send M

Keyboard Characters (continued)



Send N



Send O



Send P



Send Q



Send R



Send S



Send T

Keyboard Characters (continued)



Send U



Send V



Send W



Send X



Send Y



Send Z

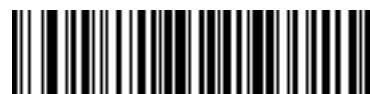

Send [

Keyboard Characters (continued)



Send \



Send]



Send ^



Send _



Send `



Send a



Send b

Keyboard Characters (continued)



Send c



Send d



Send e



Send f



Send g



Send h



Send i

Keyboard Characters (continued)



Send j



Send k



Send l



Send m



Send n



Send o



Send p

Keyboard Characters (continued)



Send q



Send r



Send s



Send t



Send u



Send v



Send w

Keyboard Characters (continued)



Send x



Send y



Send z



Send {



Send |



Send }



Send ~

Keyboard Characters (continued)



Send Tab Key



Send Enter Key

Parsing Rule Example

Scan the following bar codes in sequence to program the scanner to extract and transmit first, middle, and last names; mailing address line 1; mailing address line 2; mailing address city; mailing address state; mailing address postal code; and, date of birth. Then, scan a driver's license bar code.

✓ **NOTE** This example applies to RS-232. To use this example with a USB interface, enable *Function Key Mapping* on page 5-16 to send the Enter key properly.

1

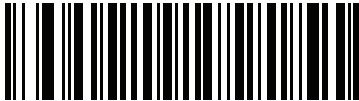

Embedded Driver's License Parsing

2

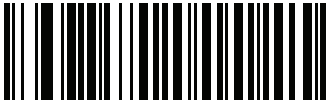

Begin New Driver's License Parse Rule

3

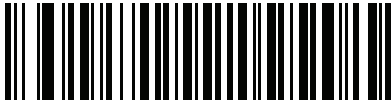

First Name

4



Send Space

5

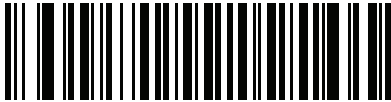

Middle Name / Initial

6



Send Space

Parsing Rule Example (continued)

7

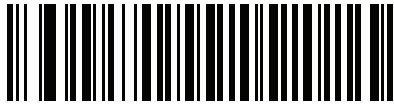

Last Name

8



Send Enter Key

9



Mailing Address Line 1

10



Send Space

11



Mailing Address Line 2

12



Send Enter Key

Parsing Rule Example (continued)

13



Mailing Address City

14



Send Space

15



Mailing Address State

16



Send Space

17



Mailing Address Postal Code

Parsing Rule Example (continued)

18



Send Enter Key

19



Birth Date

20



Send Enter Key

21



Save Driver's Licence Parse Rule

Embedded Driver's License Parsing ADF Example

This example creates a parsing rule for parsed data configured to result in the format:

Last Name, First Name

1

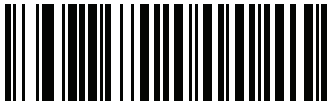

Begin New Driver's License Parse Rule

2



Last Name

3



Send ,

4



Send Space

5



First Name

6



Save Driver's License Parse Rule

Then, in order to limit the full name to 15 characters, create the following ADF rule:

1



Begin New Rule

2



Criterion: Parsed Driver's License

3



Action: Send Next 15 Characters

4



Save Rule

For a license belonging to Michael Williams, the parsed data is Williams, Michael and Williams, Micha after applying the previous ADF rule.

APPENDIX A STANDARD PARAMETER DEFAULTS

Table A-1 *Parameter Defaults*

Parameter	Parameter Number ¹	SSI Number ²	Default	Page Number
Dump Scanner Parameters	N/A	N/A	N/A	4-7
Report Software Version	N/A	N/A	N/A	4-8
Serial Number	N/A	N/A	N/A	4-8
Manufacturing Information	N/A	N/A	N/A	4-8
USB Host Parameters				
USB Device Type	N/A	N/A	USB Keyboard HID	5-6
Symbol Native API (SNAPI) Status Handshaking	N/A	N/A	Enable	5-8
USB Keystroke Delay	N/A	N/A	No Delay	5-8
USB Caps Lock Override	N/A	N/A	Disable	5-9
Bar Codes with Unknown Characters	N/A	N/A	Send Bar Codes with Unknown Characters	5-9
USB Convert Unknown to Code 39	N/A	N/A	Disable	5-10
USB Fast HID	N/A	N/A	Enable	5-11
USB Polling Interval	N/A	N/A	3 msec	5-12
Keypad Emulation	N/A	N/A	Enable	5-14
Quick Keypad Emulation	N/A	N/A	Enable	5-14
Keypad Emulation with Leading Zero	N/A	N/A	Enable	5-15

1. Parameter number decimal values are used for programming via RSM commands.
2. SSI number hex values are used for programming via SSI commands.

Table A-1 Parameter Defaults (Continued)

Parameter	Parameter Number ¹	SSI Number ²	Default	Page Number
USB FN1 Substitution	N/A	N/A	Disable	5-15
Function Key Mapping	N/A	N/A	Disable	5-16
Simulated Caps Lock	N/A	N/A	Disable	5-16
Convert Case	N/A	N/A	None	5-17
USB Static CDC	N/A	N/A	Enable	5-17
USB CDC Host Variant	1713	N/A	CDC Standard	5-18
TGCS (IBM) USB Direct I/O Beep	1360	550h	Honor	5-21
TGCS (IBM) USB Beep Directive	N/A	N/A	Ignore	5-21
TGCS (IBM) USB Bar Code Configuration Directive	N/A	N/A	Ignore	5-22
TGCS (IBM) USB Specification Version	N/A	N/A	Version 2.2	5-22
SSI Host Parameters				
Select SSI Host	N/A	N/A	N/A	6-12
Baud Rate	156	9Ch	9600	6-12
Parity	158	9Eh	None	6-13
Check Parity	151	97h	Disable	6-14
Stop Bits	157	9Dh	1	6-15
Software Handshaking	159	9Fh	ACK/NAK	6-16
Host RTS Line State	154	9Ah	Low	6-17
Decode Data Packet Format	238	EEh	Send Raw Decode Data	6-17
Host Serial Response Timeout	155	9Bh	2 Seconds	6-18
Host Character Timeout	239	EFh	200 msec	6-19
Multipacket Option	334	F0h 4Eh	Option 1	6-20
Interpacket Delay	335	F0h 4Fh	0 msec	6-21
Event Reporting				
Decode Event	256	F0h 00h	Disable	6-22
Boot Up Event	258	F0h 02h	Disable	6-23

1. Parameter number decimal values are used for programming via RSM commands.
2. SSI number hex values are used for programming via SSI commands.

Table A-1 *Parameter Defaults (Continued)*

Parameter	Parameter Number ¹	SSI Number ²	Default	Page Number
Parameter Event	259	F0h 03h	Disable	6-23
RS-232 Host Parameters				
RS-232 Host Types	N/A	N/A	Standard	7-7
Baud Rate	N/A	N/A	9600	7-9
Parity	N/A	N/A	None	7-10
Stop Bits	N/A	N/A	1 Stop Bit	7-11
Data Bits	N/A	N/A	8-bit	7-11
Check Receive Errors	N/A	N/A	Enable	7-12
Hardware Handshaking	N/A	N/A	None	7-12
Software Handshaking	N/A	N/A	None	7-14
Host Serial Response Timeout	N/A	N/A	2 Sec	7-16
RTS Line State	N/A	N/A	Low RTS	7-17
Beep on <BEL>	N/A	N/A	Disable	7-17
Intercharacter Delay	N/A	N/A	0 msec	7-18
Nixdorf Beep/LED Options	N/A	N/A	Normal Operation	7-19
Bar Codes with Unknown Characters	N/A	N/A	Send Bar Code With Unknown Characters	7-19
IBM 468X/469X Host Parameters				
Port Address	N/A	N/A	None	8-4
Convert Unknown to Code 39	N/A	N/A	Disable	8-5
RS-485 Beep Directive	N/A	N/A	Honor	8-5
RS-485 Bar Code Configuration Directive	N/A	N/A	Ignore	8-6
Keyboard Wedge Host Parameters				
Keyboard Wedge Host Type	N/A	N/A	IBM AT Notebook	9-4
Bar Codes with Unknown Characters	N/A	N/A	Send Bar Codes with Unknown Characters	9-4
Keystroke Delay	N/A	N/A	No Delay	9-5
Intra-keystroke Delay	N/A	N/A	Disable	9-5

1. Parameter number decimal values are used for programming via RSM commands.
2. SSI number hex values are used for programming via SSI commands.

Table A-1 *Parameter Defaults (Continued)*

Parameter	Parameter Number ¹	SSI Number ²	Default	Page Number
Alternate Numeric Keypad Emulation	N/A	N/A	Enable	9-6
Quick Keypad Emulation	N/A	N/A	Enable	9-6
Simulated Caps Lock	N/A	N/A	Disable	9-7
Caps Lock Override	N/A	N/A	Disable	9-7
Convert Case	N/A	N/A	Do Not Convert	9-8
Function Key Mapping	N/A	N/A	Disable	9-8
FN1 Substitution	N/A	N/A	Disable	9-9
Send Make and Break	N/A	N/A	Send Make and Break Scan Codes	9-9
User Preferences				
Set Default Parameter	N/A	N/A	N/A	10-5
Parameter Bar Code Scanning	236	ECh	Enable	10-6
Beep After Good Decode	56	38h	Enable	10-6
Beeper Volume	140	8Ch	High	10-7
Beeper Tone	145	91h	Medium	10-8
Beeper Duration	628	F1h 74h	Medium	10-9
Suppress Power Up Beeps	721	F1h D1h	Do Not Suppress	10-10
LED on Good Decode	744	F1h E8h	Enable	10-10
Direct Decode Indicator	859	F2h 5Bh	Disable	10-11
Decode Pager Motor (DS8108-HC Only)	613	F1h 65h	Enable	10-12
Decode Pager Motor Duration (DS8108-HC Only)	626	F1h 72h	150 msec	10-13
Night Mode Trigger (DS8108-HC Only)	1215	F8h 04h BFh	Disable	10-15
Night Mode Toggle (DS8108-HC Only)	N/A	N/A	N/A	10-15
Night Mode Silence Parameter Programming Beeper Indications	2264	F8h 08h D8	Enable Always	10-16
Low Power Mode	128	80h	Disable	10-18

**1. Parameter number decimal values are used for programming via RSM commands.
2. SSI number hex values are used for programming via SSI commands.**

Table A-1 *Parameter Defaults (Continued)*

Parameter	Parameter Number ¹	SSI Number ²	Default	Page Number
Time Delay to Low Power Mode	146	92h	1 Hour	10-19
Trigger Mode (or Hand-held Trigger Mode)	138	8Ah	Auto Aim	10-21
Hands-free Mode	630	F1h 76h	Enable	10-22
Hand-held Decode Aiming Pattern	306	F0h 32h	Enable	10-23
Presentation (Hands-free) Decode Aiming Pattern	590	F1h 4Eh	Enable Presentation (Hands-free) Decode Aiming Pattern on PDF	10-24
Picklist Mode	402	F0h 92h	Disable Picklist Mode Always	10-25
Continuous Bar Code Read	649	F1h 89h	Disable	10-26
Unique Bar Code Reporting	723	F1h D3h	Enable	10-26
Decode Session Timeout	136	88h	9.9 Seconds	10-27
Hands-free Decode Session Timeout	400	F0h 90h	15	10-27
Timeout Between Decodes, Same Symbol	137	89h	0.5 Seconds	10-28
Timeout Between Decodes, Different Symbols	144	90h	0.1 Seconds	10-28
Triggered Timeout, Same Symbol	724	F1h D4h	Disable	10-29
Mobile Phone/Display Mode	716	F1h CCh	Normal	10-30
PDF Prioritization	719	F1h CFh	Disable	10-31
PDF Prioritization Timeout	720	F1h D0h	200 ms	10-31
Presentation (Hands-free) Mode Field of View	609	F1h 61h	Full	10-32
Decoding Illumination	298	F0h 2Ah	Enable	10-32
Illumination Brightness	669	F1h 9Dh	High	10-33
Motion Tolerance (Hand-held Trigger Mode Only)	858	F2h 5Ah	Less	10-34

1. Parameter number decimal values are used for programming via RSM commands.
2. SSI number hex values are used for programming via SSI commands.

Table A-1 *Parameter Defaults (Continued)*

Parameter	Parameter Number ¹	SSI Number ²	Default	Page Number
Miscellaneous Options				
Enter Key	N/A	N/A	N/A	10-34
Tab Key	N/A	N/A	N/A	10-34
Transmit Code ID Character	45	2Dh	None	10-35
Prefix Value	99, 105	63h, 69h	7013 <CR><LF>	10-36
Suffix 1 Value Suffix 2 Value	98, 104 100, 106	62h, 68h 64h, 6Ah	7013 <CR><LF>	10-36
Scan Data Transmission Format	235	EBh	Data As Is	10-37
FN1 Substitution Values	103, 109	67h, 6Dh	7013 <CR><LF>	10-39
Transmit "No Read" Message	94	5E	Disable	10-40
Unsolicited Heartbeat Interval	1118	F8h 04h 5Eh	Disable	10-41
securPharm	1752	F8h 06h D8h	Disable	10-42
securPharm Output Formatting	1753	F8h 06h D9h	No Formatting	10-43
Image Capture Preferences				
Operational Modes	N/A	N/A	N/A	11-4
Image Capture Illumination	361	F0h 69h	Enable	11-5
Image Capture Autoexposure	360	F0h 68h	Enable	11-5
Fixed Exposure	567	F4h F1h 37h	100	11-6
Fixed Gain	568	F1h 38h	50	11-6
Gain / Exposure Priority for Snapshot Mode	562	F1h 32h	Autodetect	11-7
Snapshot Mode Timeout	323	F0h 43h	0 (30 seconds)	11-8
Snapshot Aiming Pattern	300	F0h 2Ch	Enable	11-9
Silence Operational Mode Changes	1293	F8h 05h 0Dh	Disable (do not silence)	11-9
Image Cropping	301	F0h 2Dh	Disable	11-10
Crop to Pixel Addresses	315 316 317 318	F4h F0h 3Bh F4h F0h 3Ch F4h F0h 3Dh F4h F0h 3Eh	0 top 0 left 959 bottom 1279 right	11-10

**1. Parameter number decimal values are used for programming via RSM commands.
2. SSI number hex values are used for programming via SSI commands.**

Table A-1 Parameter Defaults (Continued)

Parameter	Parameter Number ¹	SSI Number ²	Default	Page Number
Image Size (Number of Pixels)	302	F0h 2Eh	Full	11-12
Image Brightness (Target White)	390	F0h 86h	180	11-13
JPEG Image Options	299	F0h 2Bh	Quality	11-13
JPEG Quality Value	305	F0h 31h	65	11-14
JPEG Size Value	561	F1h 31h	160 kB	11-14
Image Enhancement	564	F1h 34h	Low (1)	11-15
Image File Format Selection	304	F0h 30h	JPEG	11-16
Image Rotation	665	F1h 99h	0	11-17
Bits per Pixel (BPP)	303	F0h 2Fh	8 BPP	11-18
Signature Capture	93	5Dh	Disable	11-19
Signature Capture Image File Format Selection	313	F0h 39h	JPEG	11-20
Signature Capture Bits per Pixel (BPP)	314	F0h 3Ah	8 BPP	11-21
Signature Capture Width	366	F4h F0h 6Eh	400	11-22
Signature Capture Height	367	F4h F0h 6Fh	100	11-22
Signature Capture JPEG Quality	421	F0h A5h	65	11-22
Video View Finder	324	F0h 44h	Disable	11-23
Video View Finder Image Size	329	F0h 49h	1700 bytes	11-23

Symbologies**Enable/Disable All Code Types**[12-9](#)**1D Symbologies****UPC/EAN/JAN**[12-10](#)

UPC-A

1

01h

Enable

[12-10](#)

UPC-E

2

02h

Enable

[12-10](#)

UPC-E1

12

0Ch

Disable

[12-11](#)

EAN-8/JAN 8

4

04h

Enable

[12-11](#)

EAN-13/JAN 13

3

03h

Enable

[12-12](#)**1. Parameter number decimal values are used for programming via RSM commands.****2. SSI number hex values are used for programming via SSI commands.**

Table A-1 *Parameter Defaults (Continued)*

Parameter	Parameter Number ¹	SSI Number ²	Default	Page Number
Bookland EAN	83	53h	Disable	12-12
Bookland ISBN Format	576	F1h 40h	ISBN-10	12-13
ISSN EAN	617	F1h 69h	Disable	12-14
Decode UPC/EAN/JAN Supplementals (2 and 5 digits)	16	10h	Ignore	12-15
User-Programmable Supplementals			000	12-18
Supplemental 1:	579	F1h 43h		
Supplemental 2:	580	F1h 44h		
UPC/EAN/JAN Supplemental Redundancy	80	50h	10	12-18
Decode UPC/EAN/JAN Supplemental AIM ID	672	F1h A0h	Combined	12-19
Transmit UPC-A Check Digit	40	28h	Enable	12-20
Transmit UPC-E Check Digit	41	29h	Enable	12-20
Transmit UPC-E1 Check Digit	42	2Ah	Enable	12-21
UPC-A Preamble	34	22h	System Character	12-22
UPC-E Preamble	35	23h	System Character	12-23
UPC-E1 Preamble	36	24h	System Character	12-24
Convert UPC-E to A	37	25h	Disable	12-25
Convert UPC-E1 to A	38	26h	Disable	12-25
EAN/JAN Zero Extend	39	27h	Disable	12-26
UCC Coupon Extended Code	85	55h	Disable	12-26
Coupon Report	730	F1h DAh	New Coupon Format	12-27
UPC Reduced Quiet Zone	1289	F8h 05h 09h	Disable	12-28
Code 128				
Code 128	8	08h	Enable	12-29
Set Length(s) for Code 128	209, 210	D1h, D2h	Any Length	12-29
GS1-128 (formerly UCC/EAN-128)	14	0Eh	Enable	12-31
ISBT 128	84	54h	Enable	12-31

1. Parameter number decimal values are used for programming via RSM commands.
2. SSI number hex values are used for programming via SSI commands.

Table A-1 *Parameter Defaults (Continued)*

Parameter	Parameter Number ¹	SSI Number ²	Default	Page Number
ISBT Concatenation	577	F1h 41h	Disable - for SR/DL models Enable - for HC models	12-32
Check ISBT Table	578	F1h 42h	Enable	12-33
ISBT Concatenation Redundancy	223	DFh	10	12-33
Ignore Code 128 <FNC4>	1254	F8h 04h E6h	Honor	12-34
Code 128 Security Level	751	F1h EFh	Security Level 1	12-35
Code 128 Reduced Quiet Zone	1208	F8h 04h B8h	Disable	12-37
Code 39				
Code 39	0	00h	Enable	12-38
Trioptic Code 39	13	0Dh	Disable	12-38
Convert Code 39 to Code 32 (Italian Pharmacy Code)	86	56h	Disable	12-39
Code 32 Prefix	231	E7h	Disable	12-39
Set Length(s) for Code 39	18, 19	12h, 13h	1 to 55	12-40
Code 39 Check Digit Verification	48	30h	Disable	12-41
Transmit Code 39 Check Digit	43	2Bh	Disable	12-42
Code 39 Full ASCII Conversion	17	11h	Disable	12-42
Code 39 Security Level	750	F1h EEh	Security Level 1	12-43
Code 39 Reduced Quiet Zone	1209	F8h 04h B9h	Disable	12-45
Code 93				
Code 93	9	09h	Enable	12-46
Set Length(s) for Code 93	26, 27	1Ah, 1Bh	1 to 55	12-46
Code 11				
Code 11	10	0Ah	Disable	12-48
Set Lengths for Code 11	28, 29	1Ch, 1Dh	4 to 55	12-48
Code 11 Check Digit Verification	52	34h	Disable	12-50
Transmit Code 11 Check Digit(s)	47	2Fh	Disable	12-51

1. Parameter number decimal values are used for programming via RSM commands.
2. SSI number hex values are used for programming via SSI commands.

Table A-1 Parameter Defaults (Continued)

Parameter	Parameter Number ¹	SSI Number ²	Default	Page Number
Interleaved 2 of 5 (ITF)				
Interleaved 2 of 5 (ITF)	6	06h	Enable	12-52
Set Lengths for I 2 of 5	22, 23	16h, 17h	6 to 55	12-52
I 2 of 5 Check Digit Verification	49	31h	Disable	12-54
Transmit I 2 of 5 Check Digit	44	2Ch	Disable	12-55
Convert I 2 of 5 to EAN 13	82	52h	Disable	12-55
I 2 of 5 Security Level	1121	F8h 04h 61h	Security Level 1	12-56
I 2 of 5 Reduced Quiet Zone	1210	F8h 04h BAh	Disable	12-57
Discrete 2 of 5 (DTF)				
Discrete 2 of 5	5	05h	Disable	12-58
Set Length(s) for D 2 of 5	20, 21	14h 15h	1 to 55	12-58
Codabar (NW - 7)				
Codabar	7	07h	Enable	12-60
Set Lengths for Codabar	24, 25	18h, 19h	4 to 55	12-60
CLSI Editing	54	36h	Disable	12-62
NOTIS Editing	55	37h	Disable	12-62
Codabar Security Level	1776	F8h 06h F0h	Security Level 1	12-63
Codabar Upper or Lower Case Start/ Stop Characters Detection	855	F2h 57h	Upper Case	12-64
MSI				
MSI	11	0Bh	Disable	12-65
Set Length(s) for MSI	30, 31	1Eh, 1Fh	4 to 55	12-65
MSI Check Digits	50	32h	One	12-67
Transmit MSI Check Digit	46	2Eh	Disable	12-67
MSI Check Digit Algorithm	51	33h	Mod 10/Mod 10	12-69
MSI Reduced Quiet Zone	1392	F8h 05h 70h	Disable	12-69
Chinese 2 of 5				
Chinese 2 of 5	408	F0h 98h	Disable	12-70

**1. Parameter number decimal values are used for programming via RSM commands.
2. SSI number hex values are used for programming via SSI commands.**

Table A-1 Parameter Defaults (Continued)

Parameter	Parameter Number ¹	SSI Number ²	Default	Page Number
Matrix 2 of 5				
Matrix 2 of 5	618	F1h 6Ah	Disable	12-71
Matrix 2 of 5 Lengths	619 620	F1h 6Bh F1h 6Ch	4 to 55	12-71
Matrix 2 of 5 Check Digit	622	F1h 6Eh	Disable	12-73
Transmit Matrix 2 of 5 Check Digit	623	F1h 6Fh	Disable	12-73
Korean 3 of 5				
Korean 3 of 5	581	F1h 45h	Disable	12-74
Inverse 1D	586	F1h 4Ah	Regular	12-75
GS1 DataBar				12-76
GS1 DataBar Omnidirectional (formerly GS1 DataBar-14), GS1 DataBar Truncated, GS1 DataBar Stacked, GS1 DataBar Stacked Omnidirectional	338	F0h 52h	Enable	12-76
GS1 DataBar Limited	339	F0h 53h	Enable	12-77
GS1 DataBar Expanded, GS1 DataBar Expanded Stacked	340	F0h 54h	Enable	12-77
Convert GS1 DataBar to UPC/EAN/JAN	397	F0h 8Dh	Disable	12-78
GS1 DataBar Security Level	1706	F8h 06h AAh	Level 1	12-79
GS1 DataBar Limited Margin Check	728	F1h D8h	Level 3	12-80
Symbology-Specific Security Features				12-81
Redundancy Level	78	4Eh	1	12-81
Security Level	77	4Dh	1	12-83
1D Quiet Zone Level	1288	F8h 05h 08h	1	12-84
Intercharacter Gap Size	381	F0h 7Dh	Normal	12-85
Composite Codes				12-86
Composite CC-C	341	F0h 55h	Disable	12-86
Composite CC-A/B	342	F0h 56h	Disable	12-86

1. Parameter number decimal values are used for programming via RSM commands.
2. SSI number hex values are used for programming via SSI commands.

Table A-1 *Parameter Defaults (Continued)*

Parameter	Parameter Number ¹	SSI Number ²	Default	Page Number
Composite TLC-39	371	F0h 73h	Disable	12-87
Composite Inverse	1113	F8h 04h 59h	Regular Only	12-87
UPC Composite Mode	344	F0h 58h	UPC Never Linked	12-88
Composite Beep Mode	398	F0h 8Eh	Beep As Each Code Type is Decoded	12-89
GS1-128 Emulation Mode for UCC/EAN Composite Codes	427	F0h ABh	Disable	12-89
2D Symbologies				12-90
PDF417	15	0Fh	Enable	12-90
MicroPDF417	227	E3h	Disable	12-90
Code 128 Emulation	123	7Bh	Disable	12-91
Data Matrix	292	F0h 24h	Enable	12-92
GS1 Data Matrix	1336	F8h 05h 38h	Disable	12-92
Data Matrix Inverse	588	F1h 4Ch	Inverse Autodetect	12-93
Decode Data Matrix Mirror Images	537	F1h 19h	Auto	12-94
Maxicode	294	F0h 26h	Disable	12-95
QR Code	293	F0h 25h	Enable	12-96
GS1 QR	1343	F8h 05h 3Fh	Disable	12-96
MicroQR	573	F1h 3Dh	Enable	12-97
Linked QR Mode	1847	737h	Linked QR Only	12-98
Aztec	574	F1h 3Eh	Enable	12-99
Aztec Inverse	589	F1h 4Dh	Inverse Autodetect	12-100
Han Xin	1167	F8h 04h 8Fh	Disable	12-101
Han Xin Inverse	1168	F8h 04h 90h	Regular	12-102
Grid Matrix	1718	F8h 06h B6h	Disable	12-103
Grid Matrix Inverse	1719	F8h 06h B7h	Regular Only	12-103
Grid Matrix Mirror	1736	F8h 06h C8h	Regular Only	12-104
DotCode	1906	F8 07 72h	Disable	12-105

1. Parameter number decimal values are used for programming via RSM commands.
2. SSI number hex values are used for programming via SSI commands.

Table A-1 *Parameter Defaults (Continued)*

Parameter	Parameter Number ¹	SSI Number ²	Default	Page Number
DotCode Inverse	1907	F8 07 73h	Autodetect	12-106
DotCode Mirrored	1908	F8 07 74h	Autodetect	12-107
DotCode Prioritize	1937	F8 07 91h	Disable	12-108
Macro PDF				12-109
Flush Macro PDF Buffer	N/A	N/A	N/A	12-109
Abort Macro PDF Entry	N/A	N/A	N/A	12-109
Postal Codes				12-110
US Postnet	89	59h	Disable	12-110
US Planet	90	5Ah	Disable	12-110
Transmit US Postal Check Digit	95	5Fh	Enable	12-111
UK Postal	91	5Bh	Disable	12-111
Transmit UK Postal Check Digit	96	60h	Enable	12-112
Japan Postal	290	F0h 22h	Disable	12-112
Australia Post	291	F0h 23h	Disable	12-113
Australia Post Format	718	F1h CEh	Autodiscriminate	12-114
Netherlands KIX Code	326	F0h 46h	Disable	12-115
USPS 4CB/One Code/Intelligent Mail	592	F1h 50h	Disable	12-115
UPU FICS Postal	611	F1h 63h	Disable	12-116
Mailmark	1337	F8h 05h 39h	Disable	12-116
OCR Programming Parameters				
OCR-A	680	F1h A8h	Disable	13-3
OCR-A Variant	684	F1h ACh	Full ASCII	13-4
OCR-B	681	F1h A9h	Disable	13-5
OCR-B Variant	685	F1h ADh	Full ASCII	13-6
MICR E13B	682	F1h AAh	Disable	13-10
US Currency	683	F1h ABh	Disable	13-11
OCR Orientation	687	F1h AFh	0°	13-11

1. Parameter number decimal values are used for programming via RSM commands.

2. SSI number hex values are used for programming via SSI commands.

Table A-1 *Parameter Defaults (Continued)*

Parameter	Parameter Number ¹	SSI Number ²	Default	Page Number
OCR Lines	691	F1h B3h	1	13-13
OCR Minimum Characters	689	F1h B1h	3	13-13
OCR Maximum Characters	690	F1h B2h	100	13-14
OCR Subset	686	F1h AEh	Selected font variant	13-14
OCR Quiet Zone	695	F1h B7h	50	13-15
OCR Template	547	F1h 23h	99999999	13-15
OCR Check Digit Modulus	688	F1h B0h	1	13-25
OCR Check Digit Multiplier	700	F1h BCh	121212121212	13-26
OCR Check Digit Validation	694	F1h B6h	None	13-27
Inverse OCR	856	F2h 58h	Regular	13-32
OCR Redundancy	1770	F8h 06h EAh	Level 1	13-33

Intelligent Document Capture (IDC) Parameters

IDC Operating Mode	594	F1h 52h	Off	14-7
IDC Symbology	655	F1h 8Fh	001	14-8
IDC X Coordinate	596	F4h F1h 54h	-151	14-9
IDC Y Coordinate	597	F4h F1h 55h	-050	14-9
IDC Width	598	F1h 56h	0300	14-10
IDC Height	599	F1h 57h	0050	14-10
IDC Aspect	595	F1h 53h	000	14-11
IDC File Format Selector	601	F1h 59h	JPEG	14-11
IDC Bits Per Pixel	602	F1h 5Ah	8 BPP	14-12
IDC JPEG Quality	603	F1h 5Bh	065	14-12
IDC Find Box Outline	727	F1h D7h	Disable	14-13
IDC Minimum Text Length	656	F1h 90h	00	14-13
IDC Maximum Text Length	657	F1h 91h	00	14-14
IDC Captured Image Brighten	654	F1h 8Eh	Enable	14-14
IDC Captured Image Sharpen	658	F1h 92h	Enable	14-15
IDC Border Type	829	F2h 3Dh	None	14-16

1. Parameter number decimal values are used for programming via RSM commands.
2. SSI number hex values are used for programming via SSI commands.

Table A-1 *Parameter Defaults (Continued)*

Parameter	Parameter Number ¹	SSI Number ²	Default	Page Number
IDC Delay Time	830	F2h 3Eh	000	14-17
IDC Zoom Limit	651	F1h 8Bh	000	14-17
IDC Maximum Rotation	652	F1h 8Ch	00	14-18
Digimarc Parameters				
Enable/Disable Digimarc	N/A	N/A	Disable	15-1
DL Parsing Parameters				
Driver's License Parsing	N/A	N/A	No Driver's License Parsing	17-2
Parsing Driver's License Data Fields	N/A	N/A	N/A	17-3
Driver's License Parse Field Bar Codes	N/A	N/A	N/A	17-4
AAMVA Parse Field Bar Codes	N/A	N/A	N/A	17-7
Set Default Parameter	N/A	N/A	N/A	17-17
Output Gender as M or F	N/A	N/A	N/A	17-17
Date Format	N/A	N/A	CCYYMMDD	17-18
No Separator	N/A	N/A	N/A	17-19
Send Keystroke Control Characters	N/A	N/A	N/A	17-20
Keyboard Characters				17-24
Parsing Rule Example	N/A	N/A	N/A	17-39
Embedded Driver's License Parsing ADF Example	N/A	N/A	N/A	17-43

1. Parameter number decimal values are used for programming via RSM commands.
2. SSI number hex values are used for programming via SSI commands.

APPENDIX B NUMERIC BAR CODES

Numeric Bar Codes

For parameters requiring specific numeric values, scan the appropriately numbered bar code(s).



0



1

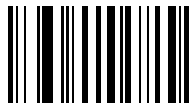

2

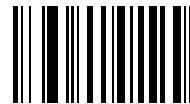

3

Numeric Bar Codes (continued)



4

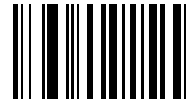

5



6

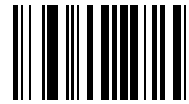

7

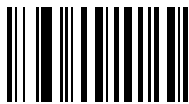

8

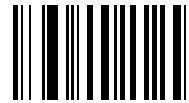

9

Cancel

To correct an error or change a selection, scan the bar code below.



Cancel

APPENDIX C ALPHANUMERIC BAR CODES

Cancel

To correct an error or change a selection, scan the following bar code.



Cancel

Alphanumeric Bar Codes



Space



#

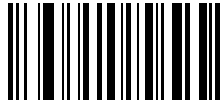

\$



%

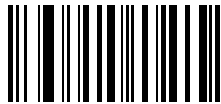

*

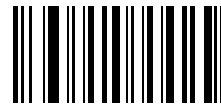

+

Alphanumeric Bar Codes (continued)



-



.



/



!



“



&

Alphanumeric Bar Codes (continued)



Alphanumeric Bar Codes (continued)



=

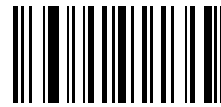

>



?

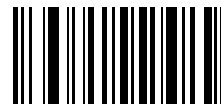

@



[

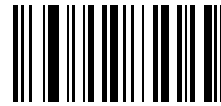

\

Alphanumeric Bar Codes (continued)



1

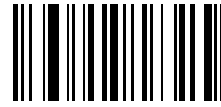

4



5



6

Alphanumeric Bar Codes (continued)

✓ **NOTE** Do not confuse the following bar codes with those on the numeric keypad.



0

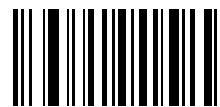

1

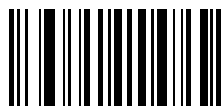

2



3



4

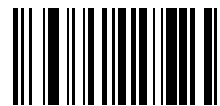

5

Alphanumeric Bar Codes (continued)



6



7



8

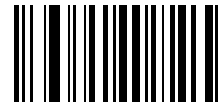

9



End of Message



Cancel

Alphanumeric Bar Codes (continued)



A

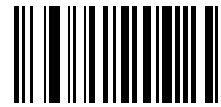

B



C

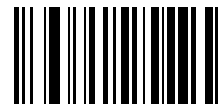

D



E

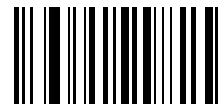

F

Alphanumeric Bar Codes (continued)



G

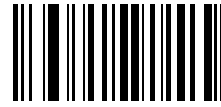

H



I

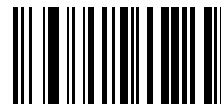

J



K

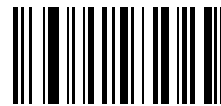

L

Alphanumeric Bar Codes (continued)



M



N



O

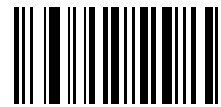

P



Q



R

Alphanumeric Bar Codes (continued)



S

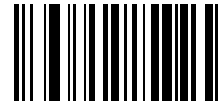

T



U



V



W

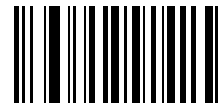

X

Alphanumeric Bar Codes (continued)



Y

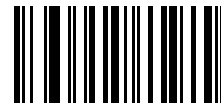

Z

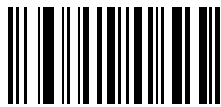

a

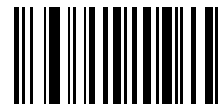

b



c

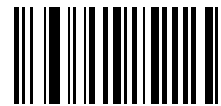

d

Alphanumeric Bar Codes (continued)



e



f



g



h

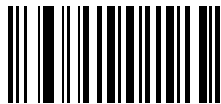

i



j

Alphanumeric Bar Codes (continued)



k



l

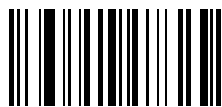

m



n

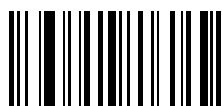

o



p

Alphanumeric Bar Codes (continued)

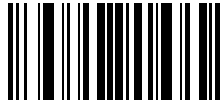

q

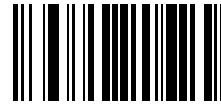

r



s

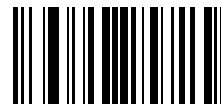

t

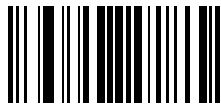

u

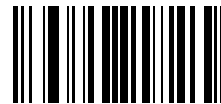

v

Alphanumeric Bar Codes (continued)

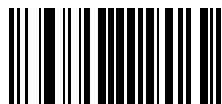

w



x



y



z



{



|

Alphanumeric Bar Codes (continued)



}



~

APPENDIX D ASCII CHARACTER SETS

✓ **NOTE** For the Keyboard Wedge Interface, Code 39 Full ASCII interprets the bar code special character (\$ + % /) preceding a Code 39 character and assigns an ASCII character value to the pair. For example, if you enable Code 39 Full ASCII and scan **+B**, it transmits as **b**, **%J** as **?**, and **%V** as **@**. Scanning **ABC%I** outputs the keystroke equivalent of **ABC >**.

Table D-1 ASCII Character Set

ASCII Value (Prefix/Suffix Value)	Full ASCII Code 39 Encode Char	Keystroke	ASCII Character (Applies to RS-232 Only)
1000	%U	CTRL 2	NUL
1001	\$A	CTRL A	SOH
1002	\$B	CTRL B	STX
1003	\$C	CTRL C	ETX
1004	\$D	CTRL D	EOT
1005	\$E	CTRL E	ENQ
1006	\$F	CTRL F	ACK
1007	\$G	CTRL G	BELL
1008	\$H	CTRL H/ BACKSPACE ¹	BCKSPC
1009	\$I	CTRL I/ HORIZONTAL TAB ¹	HORIZ TAB
1010	\$J	CTRL J	LF/NW LN
1011	\$K	CTRL K	VT
1012	\$L	CTRL L	FF
1013	\$M	CTRL M/ ENTER ¹	CR/ENTER

¹The keystroke in bold transmits only if you enabled *Function Key Mapping* on page 5-16 or [page 9-8](#). Otherwise, the unbold keystroke transmits.

Table D-1 ASCII Character Set (Continued)

ASCII Value (Prefix/Suffix Value)	Full ASCII Code 39 Encode Char	Keystroke	ASCII Character (Applies to RS-232 Only)
1014	\$N	CTRL N	SO
1015	\$O	CTRL O	SI
1016	\$P	CTRL P	DLE
1017	\$Q	CTRL Q	DC1/XON
1018	\$R	CTRL R	DC2
1019	\$S	CTRL S	DC3/XOFF
1020	\$T	CTRL T	DC4
1021	\$U	CTRL U	NAK
1022	\$V	CTRL V	SYN
1023	\$W	CTRL W	ETB
1024	\$X	CTRL X	CAN
1025	\$Y	CTRL Y	EM
1026	\$Z	CTRL Z	SUB
1027	%A	CTRL [ESC
1028	%B	CTRL \	FS
1029	%C	CTRL]	GS
1030	%D	CTRL 6	RS
1031	%E	CTRL -	US
1032	Space	Space	Space
1033	/A	!	!
1034	/B	"	"
1035	/C	#	#
1036	/D	\$	\$
1037	/E	%	%
1038	/F	&	&
1039	/G	'	'
1040	/H	((
1041	/I))

¹The keystroke in bold transmits only if you enabled *Function Key Mapping* on page 5-16 or [page 9-8](#). Otherwise, the unbold keystroke transmits.

Table D-1 ASCII Character Set (Continued)

ASCII Value (Prefix/Suffix Value)	Full ASCII Code 39 Encode Char	Keystroke	ASCII Character (Applies to RS-232 Only)
1042	/J	*	*
1043	/K	+	+
1044	/L	,	,
1045	-	-	-
1046	.	.	.
1047	/o	/	/
1048	0	0	0
1049	1	1	1
1050	2	2	2
1051	3	3	3
1052	4	4	4
1053	5	5	5
1054	6	6	6
1055	7	7	7
1056	8	8	8
1057	9	9	9
1058	/Z	:	:
1059	%F	;	;
1060	%G	<	<
1061	%H	=	=
1062	%I	>	>
1063	%J	?	?
1064	%V	@	@
1065	A	A	A
1066	B	B	B
1067	C	C	C
1068	D	D	D
1069	E	E	E

¹The keystroke in bold transmits only if you enabled *Function Key Mapping* on page 5-16 or [page 9-8](#). Otherwise, the unbold keystroke transmits.

Table D-1 ASCII Character Set (Continued)

ASCII Value (Prefix/Suffix Value)	Full ASCII Code 39 Encode Char	Keystroke	ASCII Character (Applies to RS-232 Only)
1070	F	F	F
1071	G	G	G
1072	H	H	H
1073	I	I	I
1074	J	J	J
1075	K	K	K
1076	L	L	L
1077	M	M	M
1078	N	N	N
1079	O	O	O
1080	P	P	P
1081	Q	Q	Q
1082	R	R	R
1083	S	S	S
1084	T	T	T
1085	U	U	U
1086	V	V	V
1087	W	W	W
1088	X	X	X
1089	Y	Y	Y
1090	Z	Z	Z
1091	%K	[[
1092	%L	\	\
1093	%M]]
1094	%N	^	^
1095	%O	_	_
1096	%W	‘	’
1097	+A	a	a

¹The keystroke in bold transmits only if you enabled *Function Key Mapping* on page 5-16 or [page 9-8](#). Otherwise, the unbold keystroke transmits.

Table D-1 ASCII Character Set (Continued)

ASCII Value (Prefix/Suffix Value)	Full ASCII Code 39 Encode Char	Keystroke	ASCII Character (Applies to RS-232 Only)
1098	+B	b	b
1099	+C	c	c
1100	+D	d	d
1101	+E	e	e
1102	+F	f	f
1103	+G	g	g
1104	+H	h	h
1105	+I	i	i
1106	+J	j	j
1107	+K	k	k
1108	+L	l	l
1109	+M	m	m
1110	+N	n	n
1111	+O	o	o
1112	+P	p	p
1113	+Q	q	q
1114	+R	r	r
1115	+S	s	s
1116	+T	t	t
1117	+U	u	u
1118	+V	v	v
1119	+W	w	w
1120	+X	x	x
1121	+Y	y	y
1122	+Z	z	z
1123	%P	{	{
1124	%Q		
1125	%R	}	}

¹The keystroke in bold transmits only if you enabled *Function Key Mapping* on page 5-16 or [page 9-8](#). Otherwise, the unbold keystroke transmits.

Table D-1 ASCII Character Set (Continued)

ASCII Value (Prefix/Suffix Value)	Full ASCII Code 39 Encode Char	Keystroke	ASCII Character (Applies to RS-232 Only)
1126	%S	~	~
1127			Undefined
7013			ENTER

¹The keystroke in bold transmits only if you enabled *Function Key Mapping* on page 5-16 or [page 9-8](#). Otherwise, the unbold keystroke transmits.

Table D-2 ALT Key Character Set

ALT Keys	Keystroke
2064	ALT 2
2065	ALT A
2066	ALT B
2067	ALT C
2068	ALT D
2069	ALT E
2070	ALT F
2071	ALT G
2072	ALT H
2073	ALT I
2074	ALT J
2075	ALT K
2076	ALT L
2077	ALT M
2078	ALT N
2079	ALT O
2080	ALT P
2081	ALT Q
2082	ALT R
2083	ALT S
2084	ALT T

Table D-2 ALT Key Character Set (Continued)

ALT Keys	Keystroke
2085	ALT U
2086	ALT V
2087	ALT W
2088	ALT X
2089	ALT Y
2090	ALT Z

Table D-3 GUI Key Character Set

GUI Key	Keystroke
3000	Right Control Key
3048	GUI 0
3049	GUI 1
3050	GUI 2
3051	GUI 3
3052	GUI 4
3053	GUI 5
3054	GUI 6
3055	GUI 7
3056	GUI 8
3057	GUI 9
3065	GUI A
3066	GUI B
3067	GUI C
3068	GUI D
3069	GUI E
3070	GUI F
3071	GUI G

Note: GUI Shift Keys - The Apple™ iMac keyboard has an apple key on either side of the space bar. Windows-based systems have a GUI key to the left of the left ALT key, and to the right of the right ALT key.

Table D-3 GUI Key Character Set (Continued)

GUI Key	Keystroke
3072	GUI H
3073	GUI I
3074	GUI J
3075	GUI K
3076	GUI L
3077	GUI M
3078	GUI N
3079	GUI O
3080	GUI P
3081	GUI Q
3082	GUI R
3083	GUI S
3084	GUI T
3085	GUI U
3086	GUI V
3087	GUI W
3088	GUI X
3089	GUI Y
3090	GUI Z

Note: GUI Shift Keys - The Apple™ iMac keyboard has an apple key on either side of the space bar. Windows-based systems have a GUI key to the left of the left ALT key, and to the right of the right ALT key.

Table D-4 *PF Key Character Set*

PF Keys	Keystroke
4001	PF 1
4002	PF 2
4003	PF 3
4004	PF 4
4005	PF 5
4006	PF 6
4007	PF 7
4008	PF 8
4009	PF 9
4010	PF 10
4011	PF 11
4012	PF 12
4013	PF 13
4014	PF 14
4015	PF 15
4016	PF 16

Table D-5 *F Key Character Set*

F Keys	Keystroke
5001	F 1
5002	F 2
5003	F 3
5004	F 4
5005	F 5
5006	F 6
5007	F 7
5008	F 8
5009	F 9
5010	F 10
5011	F 11
5012	F 12
5013	F 13
5014	F 14
5015	F 15
5016	F 16
5017	F 17
5018	F 18
5019	F 19
5020	F 20
5021	F 21
5022	F 22
5023	F 23
5024	F 24

Table D-6 *Numeric Key Character Set*

Numeric Keypad	Keystroke
6042	*
6043	+
6044	Undefined
6045	-
6046	.
6047	/
6048	0
6049	1
6050	2
6051	3
6052	4
6053	5
6054	6
6055	7
6056	8
6057	9
6058	Enter
6059	Num Lock

Table D-7 *Extended Key Character Set*

Extended Keypad	Keystroke
7001	Break
7002	Delete
7003	Pg Up
7004	End
7005	Pg Dn
7006	Pause
7007	Scroll Lock
7008	Backspace
7009	Tab
7010	Print Screen
7011	Insert
7012	Home
7013	Enter
7014	Escape
7015	Up Arrow
7016	Dn Arrow
7017	Left Arrow
7018	Right Arrow

APPENDIX E PROGRAMMING REFERENCE

Symbol Code Identifiers

Table E-1 *Symbol Code Characters*

Code Character	Code Type
A	UPC-A, UPC-E, UPC-E1, EAN-8, EAN-13
B	Code 39, Code 32
C	Codabar
D	Code 128, ISBT 128, ISBT 128 Concatenated
E	Code 93
F	Interleaved 2 of 5
G	Discrete 2 of 5, or Discrete 2 of 5 IATA
H	Code 11
J	MSI
K	GS1-128
L	Bookland EAN
M	Trioptic Code 39
N	Coupon Code
R	GS1 DataBar Family
S	Matrix 2 of 5
T	UCC Composite, TLC 39
U	Chinese 2 of 5

Table E-1 *Symbol Code Characters (Continued)*

Code Character	Code Type
V	Korean 3 of 5
X	ISSN EAN, PDF417, Macro PDF417, Micro PDF417
z	Aztec, Aztec Rune
P00	Data Matrix
P01	QR Code, MicroQR
P02	Maxicode
P03	US Postnet
P04	US Planet
P05	Japan Postal
P06	UK Postal
P08	Netherlands KIX Code
P09	Australia Post
P0A	USPS 4CB/One Code/Intelligent Mail
P0B	UPU FICS Postal
P0C	Mailmark
P0D	Grid Matrix, Grid Matrix Inverse, Grid Matrix Mirror
P0G	GS1 Data Matrix
P0H	Han Xin
P0Q	GS1 QR
P0X	Signature Capture

AIM Code Identifiers

Each AIM Code Identifier contains the three-character string **jcm** where:

- j = Flag Character (ASCII 93)
- c = Code Character (see [Table E-2](#))
- m = Modifier Character (see [Table E-3](#))

Table E-2 *Aim Code Characters*

Code Character	Code Type
A	Code 39, Code 39 Full ASCII, Code 32
C	Code 128, ISBT 128, ISBT 128 Concatenated, GS1-128, Coupon (Code 128 portion)
d	Data Matrix, GS1 Data Matrix
E	UPC/EAN, Coupon (UPC portion)
e	GS1 DataBar Family
F	Codabar
G	Code 93
H	Code 11
h	Han Xin
I	Interleaved 2 of 5
L	PDF417, Macro PDF417, Micro PDF417
L2	TLC 39
M	MSI
Q	QR Code, MicroQR, GS1 QR
S	Discrete 2 of 5, IATA 2 of 5
U	Maxicode
z	Aztec, Aztec Rune
X	Bookland EAN, ISSN EAN, Trioptic Code 39, Chinese 2 of 5, Matrix 2 of 5, Korean 3 of 5, US Postnet, US Planet, UK Postal, Japan Postal, Australia Post, Netherlands KIX Code, USPS 4CB/One Code/Intelligent Mail, UPU FICS Postal, Mailmark, Signature Capture
]g	Grid Matrix, Grid Matrix Inverse, Grid Matrix Mirror

E - 4 DS8108 Digital Scanner Product Reference Guide

The modifier character is the sum of the applicable option values based on [Table E-3](#).

Table E-3 *Modifier Characters*

Code Type	Option Value	Option
Code 39	0	No check character or Full ASCII processing.
	1	Reader has checked one check character.
	3	Reader has checked and stripped check character.
	4	Reader has performed Full ASCII character conversion.
	5	Reader has performed Full ASCII character conversion and checked one check character.
	7	Reader has performed Full ASCII character conversion and checked and stripped check character.
	Example: A Full ASCII bar code with check character W, A+I+MI+DW , is transmitted as J A7 AIMID where 7 = (3+4).	
Trioptic Code 39	0	No option specified at this time. Always transmit 0.
	Example: A Trioptic bar code 412356 is transmitted as J X0 412356	
Code 128	0	Standard data packet, no Function code 1 in first symbol position.
	1	Function code 1 in first symbol character position.
	2	Function code 1 in second symbol character position.
	Example: A Code (EAN) 128 bar code with Function 1 character ^{FNC1} in the first position, AIMID is transmitted as J C1 AIMID	
I 2 of 5	0	No check digit processing.
	1	Reader has validated check digit.
	3	Reader has validated and stripped check digit.
	Example: An I 2 of 5 bar code without check digit, 4123, is transmitted as J I0 4123	
Codabar	0	No check digit processing.
	1	Reader has checked check digit.
	3	Reader has stripped check digit before transmission.
	Example: A Codabar bar code without check digit, 4123, is transmitted as J F0 4123	
Code 93	0	No options specified at this time. Always transmit 0.
	Example: A Code 93 bar code 012345678905 is transmitted as J G00 12345678905	
MSI	0	Check digits are sent.
	1	No check digit is sent.
	Example: An MSI bar code 4123, with a single check digit checked, is transmitted as J M1 4123	

Table E-3 Modifier Characters (Continued)

Code Type	Option Value	Option
D 2 of 5	0	No options specified at this time. Always transmit 0.
	Example: A D 2 of 5 bar code 4123, is transmitted as JS04123	
UPC/EAN	0	Standard data packet in full EAN format, i.e., 13 digits for UPC-A, UPC-E, and EAN-13 (not including supplemental data).
	1	Two digit supplemental data only.
	2	Five digit supplemental data only.
	3	Combined data packet comprising 13 digits from EAN-13, UPC-A or UPC-E symbol and 2 or 5 digits from supplemental symbol.
	4	EAN-8 data packet.
	Example: A UPC-A bar code 012345678905 is transmitted as JE00012345678905	
Bookland EAN	0	No options specified at this time. Always transmit 0.
	Example: A Bookland EAN bar code 123456789X is transmitted as JX0123456789X	
ISSN EAN	0	No options specified at this time. Always transmit 0.
	Example: An ISSN EAN bar code 123456789X is transmitted as JX0123456789X	
Code 11	0	Single check digit
	1	Two check digits
	3	Check characters validated but not transmitted.
GS1 DataBar Family		No option specified at this time. Always transmit 0. GS1 DataBar Omnidirectional and GS1 DataBar Limited transmit with an Application Identifier "01". Note: In GS1-128 emulation mode, GS1 DataBar is transmitted using Code 128 rules (i.e., JC1).
	Example: A GS1 DataBar Omnidirectional bar code 0110012345678902 is transmitted as Je00110012345678902 .	

Table E-3 *Modifier Characters (Continued)*

Code Type	Option Value	Option
EAN.UCC Composites (GS1 DataBar, GS1-128, 2D portion of UPC composite)		Native mode transmission. Note: UPC portion of composite is transmitted using UPC rules.
	0	Standard data packet.
	1	Data packet containing the data following an encoded symbol separator character.
	2	Data packet containing the data following an escape mechanism character. The data packet does not support the ECI protocol.
	3	Data packet containing the data following an escape mechanism character. The data packet supports the ECI protocol.
		GS1-128 emulation Note: UPC portion of composite is transmitted using UPC rules.
	1	Data packet is a GS1-128 symbol (i.e., data is preceded with]JC1).
PDF417, Micro PDF417	0	Reader set to conform to protocol defined in 1994 PDF417 symbology specifications. Note: When this option is transmitted, the receiver cannot reliably determine whether ECIs have been invoked or whether data byte 92 _{DEC} has been doubled in transmission.
	1	Reader set to follow the ECI protocol (Extended Channel Interpretation). All data characters 92 _{DEC} are doubled.
	2	Reader set for Basic Channel operation (no escape character transmission protocol). Data characters 92 _{DEC} are not doubled. Note: When decoders are set to this mode, unbuffered Macro symbols and symbols requiring the decoder to convey ECI escape sequences cannot be transmitted.
	3	The bar code contains a GS1-128 symbol, and the first codeword is 903-907, 912, 914, 915.
	4	The bar code contains a GS1-128 symbol, and the first codeword is in the range 908-909.
	5	The bar code contains a GS1-128 symbol, and the first codeword is in the range 910-911.

Table E-3 *Modifier Characters (Continued)*

Code Type	Option Value	Option
Data Matrix	0	ECC 000-140, not supported.
	1	ECC 200.
	2	ECC 200, FNC1 in first or fifth position.
	3	ECC 200, FNC1 in second or sixth position.
	4	ECC 200, ECI protocol implemented.
	5	ECC 200, FNC1 in first or fifth position, ECI protocol implemented.
	6	ECC 200, FNC1 in second or sixth position, ECI protocol implemented.
GS1 Data Matrix	2	ECC 200, FNC1 in first or fifth position.
MaxiCode	0	Symbol in Mode 4 or 5.
	1	Symbol in Mode 2 or 3.
	2	Symbol in Mode 4 or 5, ECI protocol implemented.
	3	Symbol in Mode 2 or 3, ECI protocol implemented in secondary message.
QR Code	0	Model 1 symbol.
	1	Model 2 / MicroQR symbol, ECI protocol not implemented.
	2	Model 2 symbol, ECI protocol implemented.
	3	Model 2 symbol, ECI protocol not implemented, FNC1 implied in first position.
	4	Model 2 symbol, ECI protocol implemented, FNC1 implied in first position.
	5	Model 2 symbol, ECI protocol not implemented, FNC1 implied in second position.
	6	Model 2 symbol, ECI protocol implemented, FNC1 implied in second position.
GS1 QR	3	Model 2 symbol, ECI protocol not implemented, FNC1 implied in first position.
Aztec	0	Aztec symbol.
	C	Aztec Rune symbol.

Table E-3 *Modifier Characters (Continued)*

Code Type	Option Value	Option
Han Xin	0	Generic data, no special features are set. The transmitted data does not follow the AIM ECI protocol.
	1	ECI protocol enabled. There is at least one ECI mode encoded. Transmitted data must follow the AIM ECI protocol.
Grid Matrix, Grid Matrix Inverse, Grid Matrix Mirror	0	No options specified at this time. Always transmit 0.
Mailmark	0	No option specified at this time. Always transmit 0.

APPENDIX F COMMUNICATION PROTOCOL FUNCTIONALITY

Functionality Supported via Communication (Cable) Interface

[Table F-1](#) lists supported scanner functionality by communication protocol.

Table F-1 Communication Interface Functionality

Communication Interfaces	Functionality		
	Data Transmission	Remote Management	Image and Video Transmission
USB			
HID Keyboard Emulation	Supported	Not Available	Not Available
CDC COM Port Emulation	Supported	Not Available	Not Available
SSI over CDC COM Port Emulation	Supported	Supported	Supported
IBM Table-top USB	Supported	Supported	Not Available
IBM Hand-held USB	Supported	Supported	Not Available
USB OPOS Hand-held	Supported	Supported	Not Available
Symbol Native API (SNAPI) without Imaging Interface	Supported	Supported	Not Available
Symbol Native API (SNAPI) with Imaging Interface	Supported	Supported	Supported
RS-232			
Standard RS-232	Supported	Not Available	Not Available
ICL RS-232	Supported	Not Available	Not Available
Fujitsu RS-232	Supported	Not Available	Not Available
Wincor-Nixdorf RS-232 Mode A	Supported	Not Available	Not Available
Wincor-Nixdorf RS-232 Mode B	Supported	Not Available	Not Available

Table F-1 *Communication Interface Functionality (Continued)*

Communication Interfaces	Functionality		
	Data Transmission	Remote Management	Image and Video Transmission
Olivetti ORS4500	Supported	Not Available	Not Available
Omron	Supported	Not Available	Not Available
CUTE	Supported	Not Available	Not Available
OPOS/JPOS	Supported	Not Available	Not Available
SSI	Supported	Supported	Supported
IBM 4690			
Hand-held Scanner Emulation (Port 9B)	Supported	Not Available	Not Available
Table-top Scanner Emulation (Port 17)	Supported	Supported	Not Available
Non-IBM Scanner Emulation (Port 5B)	Supported	Supported	Not Available
Keyboard Wedge			
IBM PC/AT & IBM PC Compatibles	Supported	Not Available	Not Available
IBM AT Notebook	Supported	Not Available	Not Available

APPENDIX G COUNTRY CODES

Introduction

This chapter provides instructions for programming the keyboard to interface with a USB or keyboard wedge host. The host powers the scanner. For host setup information, see [Chapter 5, USB Interface](#) and [Chapter 9, Keyboard Wedge Interface](#).

To select a code page for the country keyboard type, see [Appendix H, Country Code Pages](#).

Throughout the programming bar code menus, default values are indicated with asterisks (*).

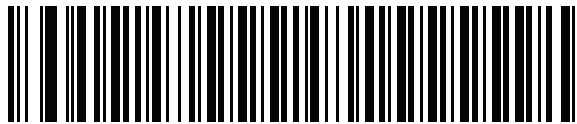

*Indicates Default — *US English (North American) — Feature/Option

USB and Keyboard Wedge Country Keyboard Types (Country Codes)

Scan the bar code corresponding to the keyboard type. For a USB host, this setting applies only to the USB Keyboard (HID) device. If the keyboard type is not listed, see *Keypad Emulation on page 5-14* for the USB HID host. For a keyboard wedge host, see *Alternate Numeric Keypad Emulation on page 9-6*.



NOTE When changing USB country keyboard types the scanner automatically resets and issues the standard startup beep sequences.



NOTE For best results when using international keyboards, enable *Quick Keypad Emulation on page 5-14*.



IMPORTANT 1. Some country keyboard bar code types are specific to certain Windows operating systems (i.e., XP and Windows 7 or higher). Bar codes requiring a specific Windows OS are noted in the bar code captions.

2. Use the **French International** bar code for Belgian French keyboards.

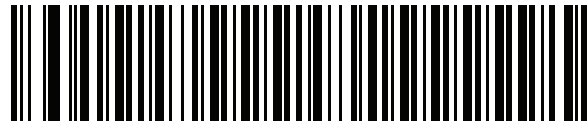

***US English (North American)**

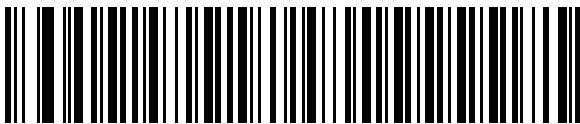

US English (Mac)

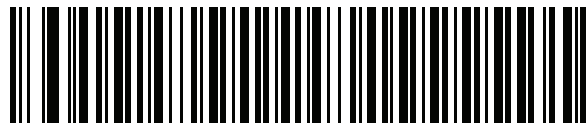

Albanian



Arabic (101)

Country Codes (Continued)



Arabic (102)

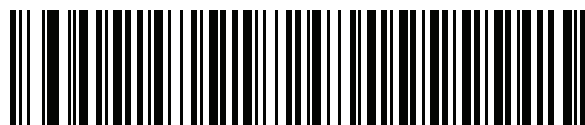

Arabic (102) AZERTY

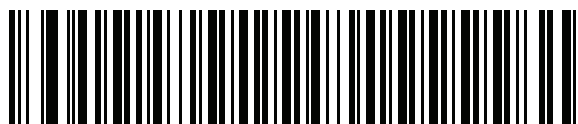

Azeri (Latin)



Azeri (Cyrillic)



Belarusian



Bosnian (Latin)



Bosnian (Cyrillic)

Country Codes (Continued)

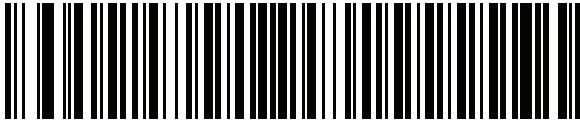

Bulgarian (Latin)



**Bulgarian Cyrillic (Typewriter)
(Bulgarian -Windows XP
Typewriter - Windows 7 or higher)**

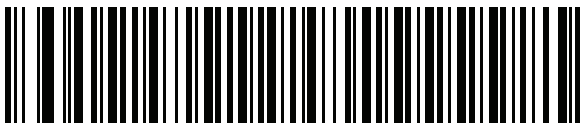

Canadian French Win7



Canadian French (Legacy)

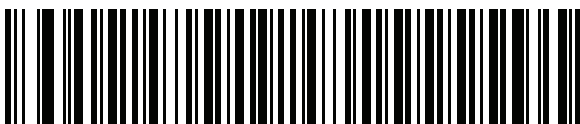

Canadian Multilingual Standard



Chinese (ASCII)

Country Codes (Continued)

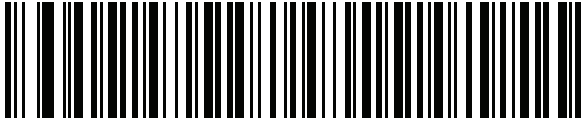

Chinese (Simplified)*

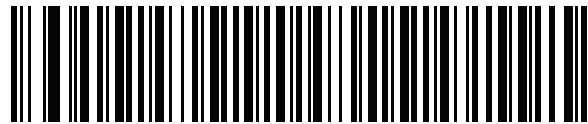

Chinese (Traditional)*

*For CJK keyboard types, see [Appendix I, CJK Decode Control](#).

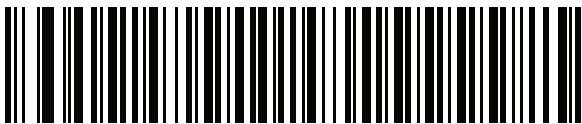

Croatian



Czech

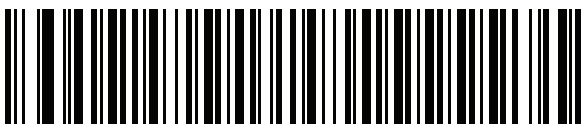

Czech (Programmer)



Czech (QWERTY)



Danish

Country Codes (Continued)



Dutch (Netherlands)

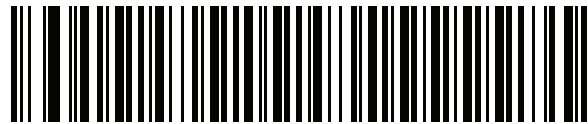

Estonian

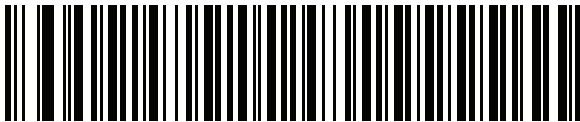

Faeroese

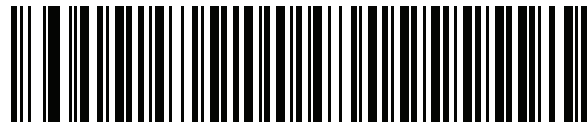

Finnish

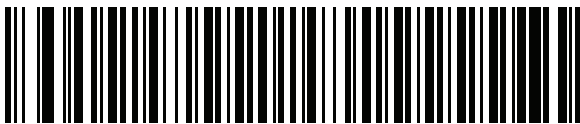

French (France)



**French International
(Belgian French)**



French (Canada) 95/98

Country Codes (Continued)

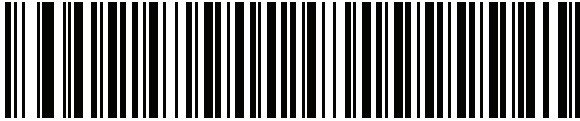

French (Canada) 2000/XP*

*There is also a country code bar code for *Canadian Multilingual Standard* on page G-4. Be sure to select the appropriate bar code for your host system.

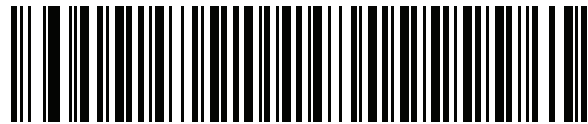

Galician

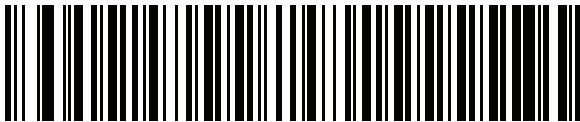

German



Greek Latin



Greek (220) Latin



Greek (319) Latin



Greek

Country Codes (Continued)

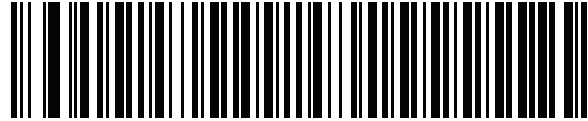

Greek (220)

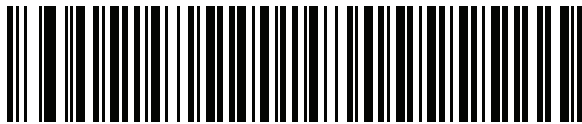

Greek (319)

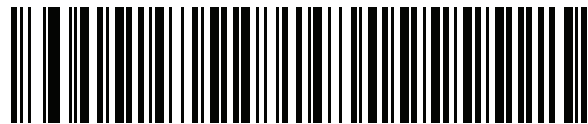

Greek Polytonic



Hebrew Israel

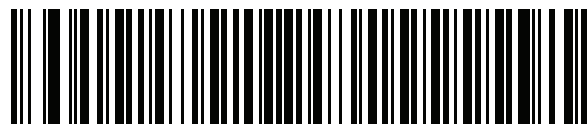

Hungarian



Hungarian_101KEY



Icelandic

Country Codes (Continued)



Irish

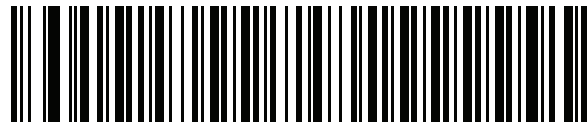

Italian

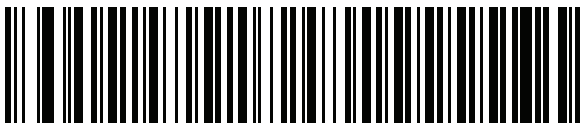

Italian (142)



Japanese (ASCII)



Japanese (SHIFT-JIS)*

*For CJK keyboard types, see [Appendix I, CJK Decode Control](#).



Kazakh



Korean (ASCII)

Country Codes (Continued)

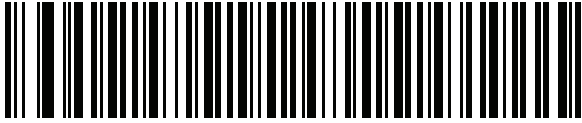

Korean (Hangul)*

*For CJK keyboard types, see [Appendix I, CJK Decode Control](#).

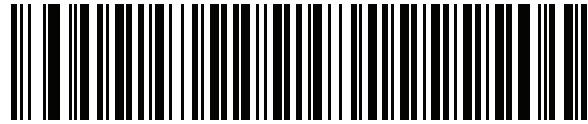

Kyrgyz

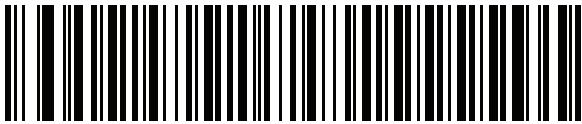

Latin American



Latvian

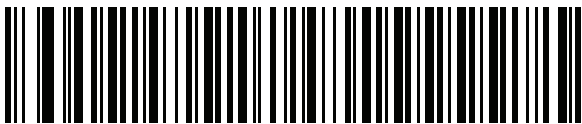

Latvian (QWERTY)

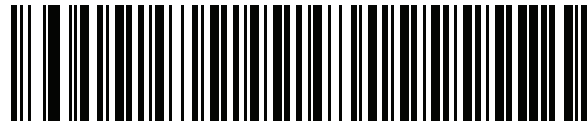

Lithuanian



Lithuanian (IBM)

Country Codes (Continued)

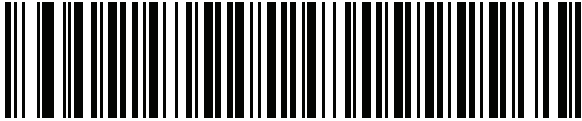

Macedonian (FYROM)

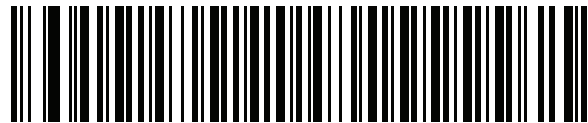

Maltese_47KEY



Mongolian



Norwegian



Polish (214)



Polish (Programmer)



**Portuguese (Brazil)
(Windows XP)**

Country Codes (Continued)

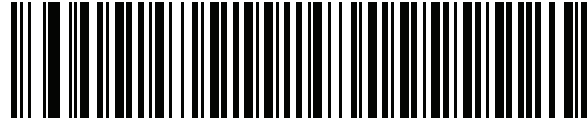

Portuguese (Brazilian ABNT)

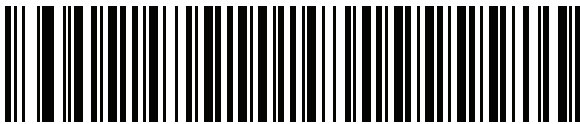

Portuguese (Brazilian ABNT2)

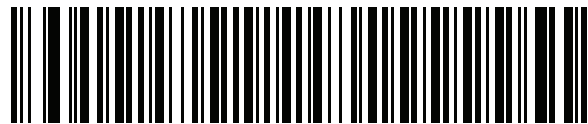

Portuguese (Portugal)



**Romanian
(Windows XP)**

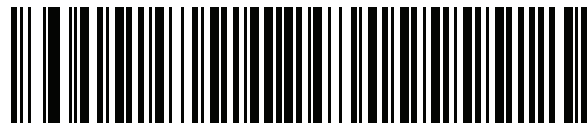

**Romanian (Legacy)
(Windows 7 or higher)**



**Romanian (Standard)
(Windows 7 or higher)**

Country Codes (Continued)

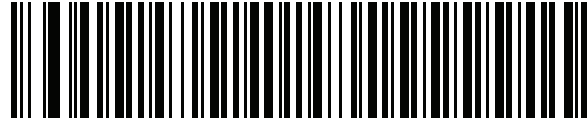

**Romanian (Programmer)
(Windows 7 or higher)**

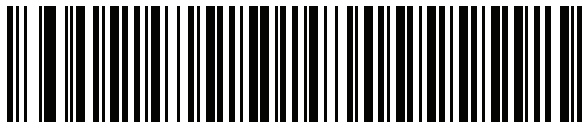

Russian



Russian (Typewriter)



Serbian (Latin)



Serbian (Cyrillic)



Slovak

Country Codes (Continued)

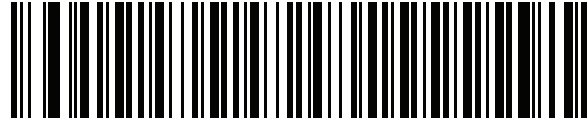

Slovak (QWERTY)



Slovenian

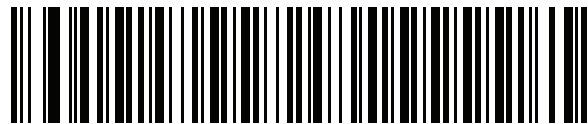

Spanish



Spanish (Variation)



Swedish



Swiss French



Swiss German

Country Codes (Continued)



Tatar

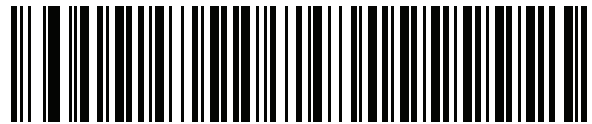

Thai (Kedmanee)

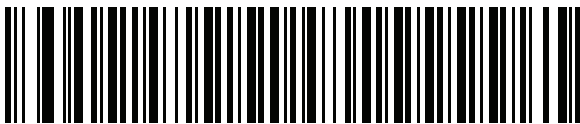

Turkish F

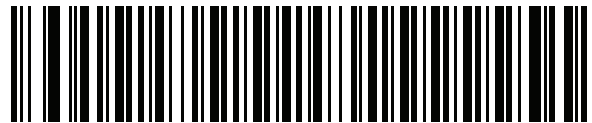

Turkish Q



UK English

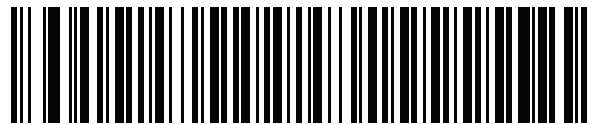

Ukrainian



US Dvorak

Country Codes (Continued)

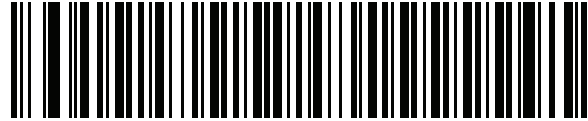

US Dvorak Left

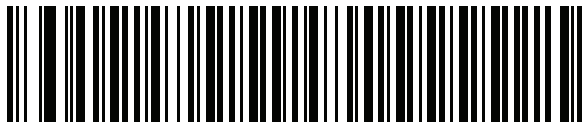

US Dvorak Right

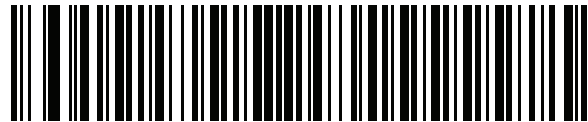

US International

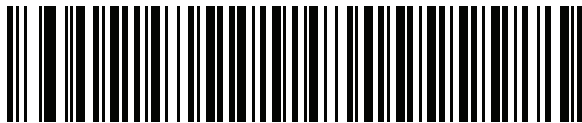

Uzbek



Vietnamese

APPENDIX H COUNTRY CODE PAGES

Introduction

This chapter provides bar codes for selecting code pages for the country keyboard type selected in [Appendix G, Country Codes](#). If the default code page in [Table H-1](#) is appropriate for your selected country keyboard type, you do not need to scan a country code page bar code.

✓ **NOTE** ADF rules can also specify a code page based on the symbology and other ADF criteria. Refer to the *Advanced Data Formatting Programmer Guide*.

Country Code Page Defaults

[Table H-1](#) lists the code page default for each country keyboard.

Table H-1 *Country Code Page Defaults*

Country Keyboard	Code Page Default
US English (North American)	Windows 1252
US English (Mac)	Mac CP10000
Albanian	Windows 1250
Arabic 101	Windows 1256
Arabic 102	Windows 1256
Arabic 102 AZERTY	Windows 1256
Azeri Latin	Windows 1254
Azeri Cyrillic	Windows 1251
Belarusian	Windows 1251
Bosnian Latin	Windows 1250

Table H-1 Country Code Page Defaults (Continued)

Country Keyboard	Code Page Default
Bosnian Cyrillic	Windows 1251
Bulgarian Latin	Windows 1250
Bulgarian Cyrillic	Windows 1251
Canadian French Win7	Windows 1252
Canadian French (Legacy)	Windows 1252
Canadian Multilingual	Windows 1252
Croatian	Windows 1250
Chinese ASCII	Windows 1252
Chinese (Simplified)	Windows 936, GBK
Chinese (Traditional)	Windows 950, Big5
Czech	Windows 1250
Czech Programmers	Windows 1250
Czech QWERTY	Windows 1250
Danish	Windows 1252
Dutch Netherland	Windows 1252
Estonian	Windows 1257
Faeroese	Windows 1252
Finnish	Windows 1252
French (France)	Windows 1252
French (Canada) 95/98	Windows 1252
French (Canada) 2000/XP	Windows 1252
French International (Belgian French)	Windows 1252
Galician	Windows 1252
German	Windows 1252
Greek Latin	Windows 1252
Greek220 Latin	Windows 1253
Greek319 Latin	Windows 1252
Greek	Windows 1253
Greek220	Windows 1253
Greek319	Windows 1253

Table H-1 Country Code Page Defaults (Continued)

Country Keyboard	Code Page Default
Greek Polytonic	Windows 1253
Hebrew Israel	Windows 1255
Hungarian	Windows 1250
Hungarian_101KEY	Windows 1250
Icelandic	Windows 1252
Irish	Windows 1252
Italian	Windows 1252
Italian_142	Windows 1252
Japanese ASCII	Windows 1252
Japanese (Shift-JIS)	Windows 932, Shift-JIS
Kazakh	Windows 1251
Korean ASCII	Windows 1252
Korean (Hangul)	Windows 949, Hangul
Kyrgyz Cyrillic	Windows 1251
Latin America	Windows 1252
Latvian	Windows 1257
Latvian QWERTY	Windows 1257
Lithuanian	Windows 1257
Lithuanian_IBM	Windows 1257
Macedonian -FYROM	Windows 1251
Maltese_47KEY	Windows 1252
Mongolian-Cyrillic	Windows 1251
Norwegian	Windows 1252
Polish_214	Windows 1250
Polish Programmer	Windows 1250
Portuguese Brazil	Windows 1252
Portuguese Brazilian ABNT	Windows 1252
Portuguese Brazilian ABNT2	Windows 1252
Portuguese Portugal	Windows 1252
Romanian	Windows 1250

Table H-1 Country Code Page Defaults (Continued)

Country Keyboard	Code Page Default
Romanian Legacy	Windows 1250
Romanian Standard	Windows 1250
Romanian Programmer	Windows 1250
Russian	Windows 1251
Russian Typewriter	Windows 1251
Serbian Latin	Windows 1250
Serbian Cyrillic	Windows 1251
Slovak	Windows 1250
Slovak QWERTY	Windows 1250
Slovenian	Windows 1250
Spanish	Windows 1252
Spanish Variation	Windows 1252
Swedish	Windows 1252
Swiss French	Windows 1252
Swiss German	Windows 1252
Tatar	Windows 1251
Thai-Kedmanee	Windows 874
Turkish F	Windows 1254
Turkish Q	Windows 1254
Ukrainian	Windows 1251
United Kingdom	Windows 1252
United States	Windows 1252
US Dvorak	Windows 1252
US Dvorak Left Hand	Windows 1252
US Dvorak Right Hand	Windows 1252
US International	Windows 1252
Uzbek Cyrillic	Windows 1251
Vietnamese	Windows 1258

Country Code Page Bar Codes

Scan the bar code corresponding to the country keyboard code page.

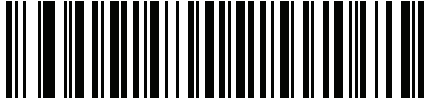

Windows 1250
Latin 2, Central European

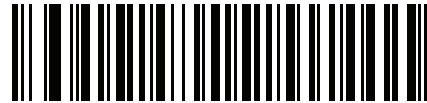

Windows 1251
Cyrillic, Slavic

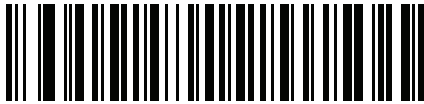

Windows 1252
Latin 1, Western European

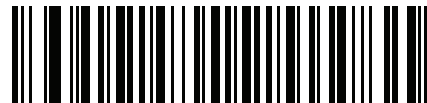

Windows 1253
Greek



Windows 1254
Latin 5, Turkish

Country Code Pages (Continued)



**Windows 1255
Hebrew**

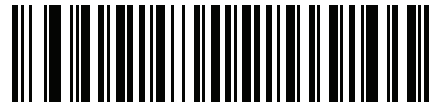

**Windows 1256
Arabic**

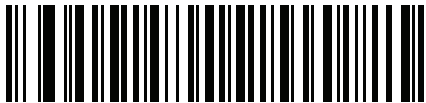

**Windows 1257
Baltic**

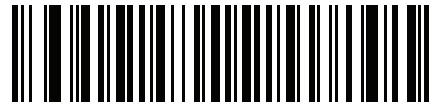

**Windows 1258
Vietnamese**



**Windows 874
Thai**

Country Code Pages (Continued)

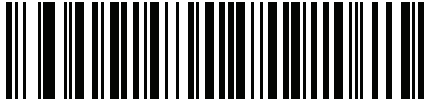

**Windows 20866
Cyrillic KOI8-R**

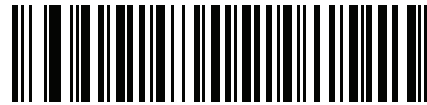

**Windows 932
Japanese Shift-JIS**



**Windows 936
Simplified Chinese GBK**

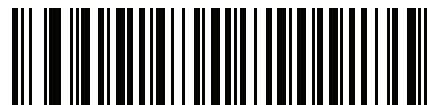

**Windows 54936
Simplified Chinese GB18030**

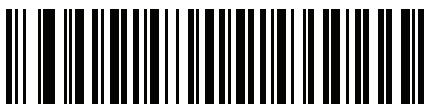

**Windows 949
Korean Hangul**

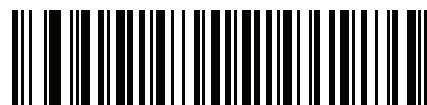

**Windows 950
Traditional Chinese Big5**

Country Code Pages (Continued)



**MS-DOS 437
Latin US**



**MS-DOS 737
Greek**

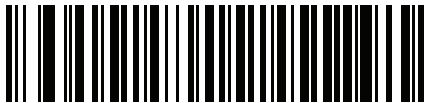

**MS-DOS 775
Baltic**



**MS-DOS 850
Latin 1**

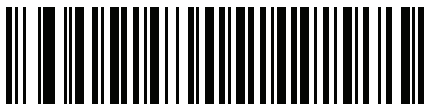

**MS-DOS 852
Latin 2**

Country Code Pages (Continued)



**MS-DOS 855
Cyrillic**

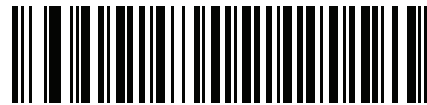

**MS-DOS 857
Turkish**

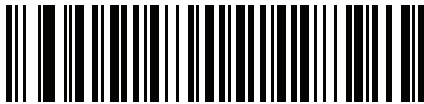

**MS-DOS 860
Portuguese**

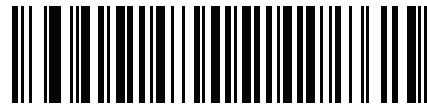

**MS-DOS 861
Icelandic**

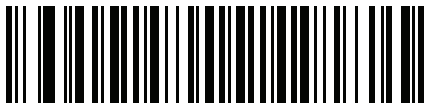

**MS-DOS 862
Hebrew**

Country Code Pages (Continued)



**MS-DOS 863
French Canada**

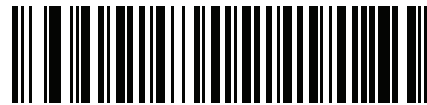

**MS-DOS 865
Nordic**

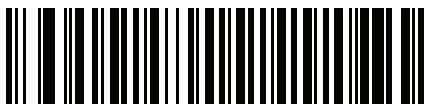

**MS-DOS 866
Cyrillic**

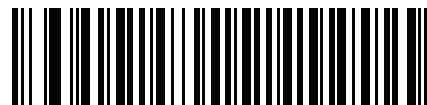

**MS-DOS 869
Greek 2**

Country Code Pages (Continued)

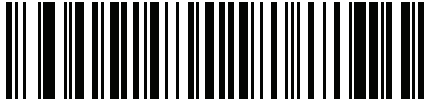

ISO 8859-1
Latin 1, Western European

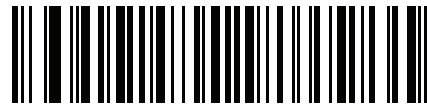

ISO 8859-2
Latin 2, Central European



ISO 8859-3
Latin 3, South European



ISO 8859-4
Latin 4, North European



ISO 8859-5
Cyrillic

Country Code Pages (Continued)

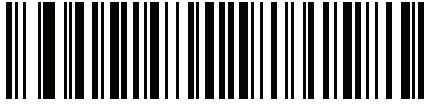

ISO 8859-6
Arabic

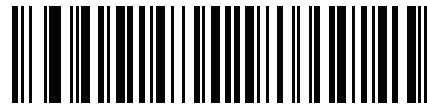

ISO 8859-7
Greek

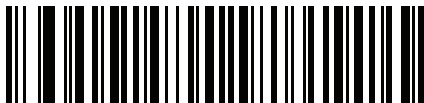

ISO 8859-8
Hebrew



ISO 8859-9
Latin 5, Turkish



ISO 8859-10
Latin 6, Nordic

Country Code Pages (Continued)

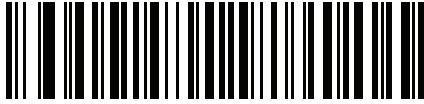

**ISO 8859-11
Thai**

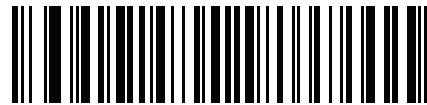

**ISO 8859-13
Latin 7, Baltic**

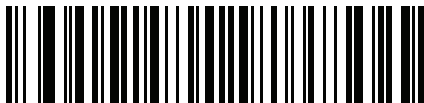

**ISO 8859-14
Latin 8, Celtic**



**ISO 8859-15
Latin 9**



**ISO 8859-16
Latin 10, South-Eastern European**

Country Code Pages (Continued)



UTF-8



UTF-16LE
UTF-16 Little Endian

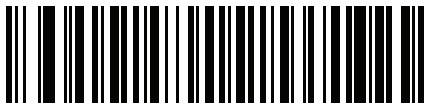

UTF-16BE
UTF-16 Big Endian

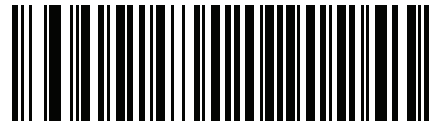

Mac CP1000
Roman

APPENDIX I CJK DECODE CONTROL

Introduction

This appendix describes control parameters for CJK (Chinese, Japanese, Korean) bar code decode through USB HID Keyboard Emulation mode.

✓ **NOTE** Because ADF does not support CJK character processing, there is no format manipulation for CJK output.

CJK Control Parameters

Unicode Output Control

Parameter # 973

For a Unicode encoded CJK bar code, select one of the following options for unicode output:

- **Universal Output to Unicode and MBCS Application** - This default method applies to Unicode and MBCS expected applications, such as MS Word and Notepad on a Windows host.
- ✓ **NOTE** To support Unicode universal output, set up the registry table for the Windows host. See *Unicode/CJK Decode Setup with Windows Host* on page I-7.
- **Output to Unicode Application Only** - This method applies only to Unicode expected applications, such as MS Word and WordPad, but not Notepad.

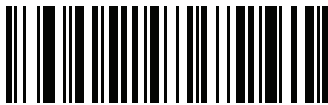

***Universal Output
(0)**



**Unicode Application Only
(1)**

CJK Output Method to Windows Host

Parameter # 972

For a national standard encoded CJK bar code, select one of the following options for CJK output to a Windows host:

- **Universal CJK Output** - This is the default universal CJK output method for US English IME or Chinese/Japanese/Korean ASCII IME on a Windows host. This method converts CJK characters to Unicode and emulates the characters when transmitting to the host. Use the [Unicode Output Control](#) parameter to control Unicode output.
- ✓ **NOTE** To support universal CJK output, set up the registry table for the Windows host. See *Unicode/CJK Decode Setup with Windows Host on page I-7*.
- **Other options for CJK output** - With the following methods, the scanner sends the CJK character hexadecimal internal code (Nei Ma) value to the host, or converts the CJK character to Unicode and sends the hexadecimal Unicode value to the host. When using these methods, the Windows host must select the corresponding IME to accept the CJK character. See *Unicode/CJK Decode Setup with Windows Host on page I-7*.
 - **Japanese Unicode Output**
 - **Simplified Chinese GBK Code Output**
 - **Simplified Chinese Unicode Output**
 - **Korean Unicode Code Output**
 - **Traditional Chinese Big5 Code Output** (Windows XP)
 - **Traditional Chinese Big5 Code Output** (Windows 7)
 - **Traditional Chinese Unicode Code Output** (Windows XP)
 - **Traditional Chinese Unicode Code Output** (Windows 7)

- ✓ **NOTE** The Unicode emulate output method depends on the host system (Windows XP or Windows 7).



***Universal CJK Output
(0)**



**Japanese Unicode Output
(34)**

(For Japanese Unicode Output, select Simplified Chinese Unicode IME on the Windows host)

CJK Output Method to Windows Host (continued)

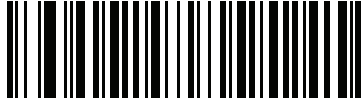

**Chinese (Simplified) GBK Output
(1)**

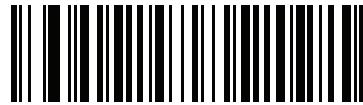

**Chinese (Simplified) Unicode Output
(2)**



**Korean Unicode Output
(50)**

(for Korean Unicode Output, select Simplified Chinese Unicode IME on the Windows host)

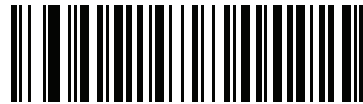

**Chinese (Traditional) Big5 Output (Windows XP)
(17)**



**Chinese (Traditional) Big5 Output (Windows 7)
(19)**

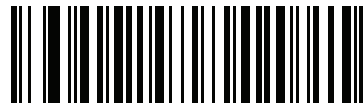

**Chinese (Traditional) Unicode Output (Windows XP)
(18)**

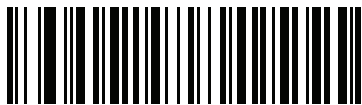

**Chinese (Traditional) Unicode Output (Windows 7)
(20)**

Non-CJK UTF Bar Code Output

Parameter # 960

Some country keyboard type layouts contain characters that do not exist in the default code page (see *Country Keyboard Type Missing Characters on page I-6*). Although the default code page can not encode these characters in a bar code, they can be encoded in the UTF-8 bar code. Scan the following bar code to output the Unicode values by emulation mode.

- ✓ **NOTE** Use this special country keyboard type to decode the non-CJK UTF-8 bar code. After decoding, re-configure the scanner to use the original country keyboard type.

Use US English IME on Windows. See *Unicode Output Control on page I-2*.



Non-CJK UTF-8 Emulation Output

Country Keyboard Type Missing Characters

Country keyboard type: **Tatar, Uzbek, Mongolian, Kyrgyz, Kazakh and Azeri**

Default code page: CP1251

Missing characters:

ƒ	F
х	Х
к	К
h	Һ
ө	Ө
ә	Ә
Ү	У
н	Ң
ж	Ж
Ғ	
ң	Ң
Ү	У
к	К
ч	Ч
к	К

Country keyboard type: **Romanian (Standard)**

Default code page: CP1250

Missing characters:

ș	Ș
ț	Ț

Country keyboard type: **Portuguese-Brazilian (ABNT), Portuguese-Brazilian (ABNT2)**

Default code page: CP1252

Missing character: **€**

Country keyboard type: **Azeri-Latin**

Default code page: CP1254

Missing characters: ə, Ə

Unicode/CJK Decode Setup with Windows Host

This section describes how to set up CJK decode with a Windows host.

Setting Up the Windows Registry Table for Unicode Universal Output

To support the Unicode universal output method, set up the Windows host registry table as follows:

1. Select **Start > Run > regedt32** to start the registry editor.
2. Under **HKEY_CURRENT_USER\Control Panel\Input Method**, set **EnableHexNumpad** to **1** as follows:
[HKEY_CURRENT_USER\Control Panel\Input Method]
"EnableHexNumpad"="1"
If this key does not exist, add it as type **REG_SZ** (string value).
3. Reboot the computer to implement the registry change.

Adding CJK IME on Windows

To add the desired CJK input language:

1. Click **Start > Control Panel**.
2. If the Control Panel opens in category view, select **Switch to Classic View** in the top left corner.
3. Select **Regional and Language Options**.
4. Click the **Language** tab.
5. Under **Supplemental Language Support**, select the **Install Files for East Asian Languages** check box if not already selected, and click **Apply**. This may require a Windows installation CD to install the required files. This step ensures that the East Asian Languages (CJK) are available.
6. Under **Text Services and Input Language**, click **Details**.
7. Under **Installed Services**, click **Add**.
8. In the **Add Input Language** dialog box, choose the CJK input language and keyboard layout or Input Method Editor (IME) to add.
9. Click **OK** twice. The language indicator appears in the system tray (at bottom right corner of the desktop by default). To switch between input languages (keyboard languages) select the language indicator in the system tray.
10. Select the language indicator in the system tray to select the desired country keyboard type.
11. Verify that the characters displayed on each country's keyboard appear.

Selecting the Simplified Chinese Input Method on the Host

To select the Simplified Chinese input method:

- Select Unicode/GBK input on Windows XP: **Chinese (Simplified) - NeiMa**, then click the input bar to select **Unicode** or **GBK NeiMa** input.

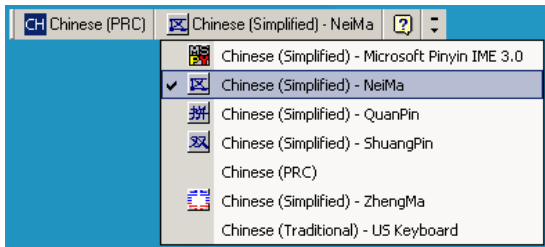

Or



- Select Unicode/GBK input on Windows 7: **Chinese (Simplified) - Microsoft Pinyin New Experience Input Style**, then select **Tool Menu > Secondary Inputs > Unicode Input** or **GB Code Input**.

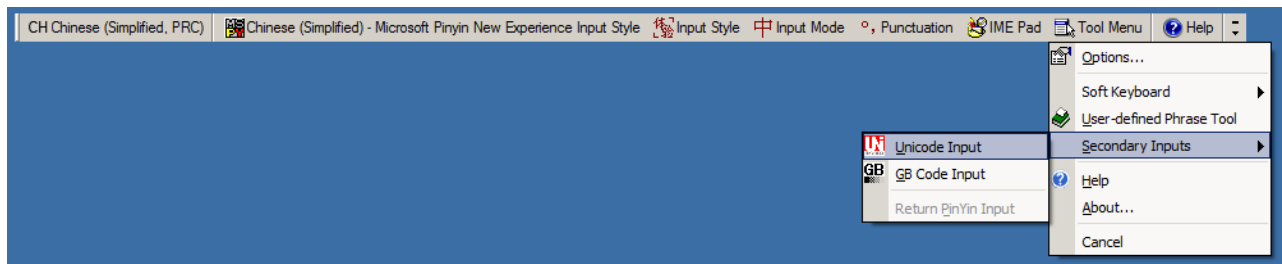

Selecting the Traditional Chinese Input Method on the Host

To select the Traditional Chinese input method:

- Select Unicode input on Windows XP: **Chinese (Traditional) - Unicode**

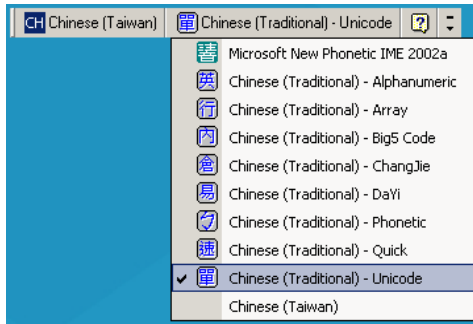

- Select Big5 input on Windows XP: **Chinese (Traditional) - Big5 Code**

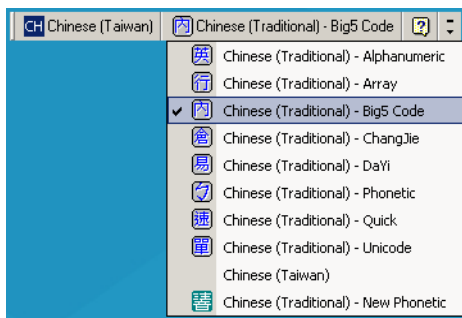

- Select Unicode/Big5 input on Windows 7: **Chinese (Traditional) - New Quick**. This option support both Unicode and Big5 input.

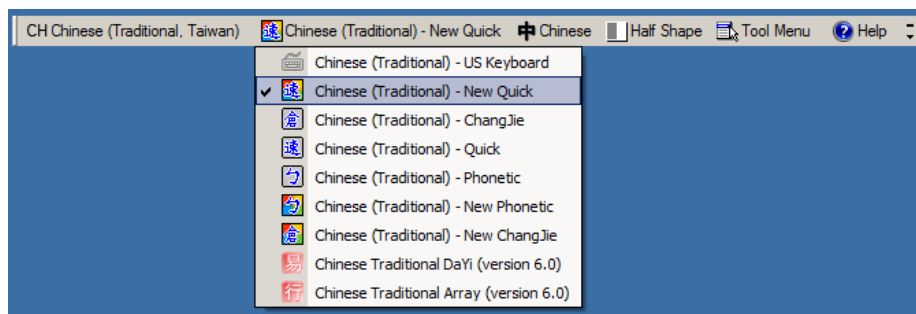

APPENDIX J SIGNATURE CAPTURE CODE

Introduction

CapCode, a signature capture code, is a special pattern that encloses a signature area on a document and allows a scanner to capture a signature.

There are several accepted patterns that allow automatic identification of different signatures on the same form. For example, on the federal tax return 1040 form there are three signature areas, one each for two joint filers, and one for a professional preparer. By using different patterns, a program can correctly identify all three, so they can be captured in any sequence and still be identified correctly.

Code Structure

Signature Capture Area

A CapCode is printed as two identical patterns on either side of a signature capture box, as shown in [Figure J-1](#). Each pattern extends the full height of the signature capture box.

The box is optional, so you can omit it, replace it with a single baseline, or print a baseline with an "X" on top of it towards the left, as is customarily done in the US to indicate a request for signature. However, if an "X" or other markings are added in the signature box area, these are captured with the signature.



Figure J-1 CapCode

CapCode Pattern Structure

A CapCode pattern structure consists of a start pattern followed by a separator space, a signature capture box, a second separator space, and then a stop pattern. Assuming that X is the dimension of the thinnest element, the start and stop patterns each contains $9X$ total width in 4 bars and 3 spaces. A $7X$ quiet zone is required to the left and to the right of the CapCode pattern.

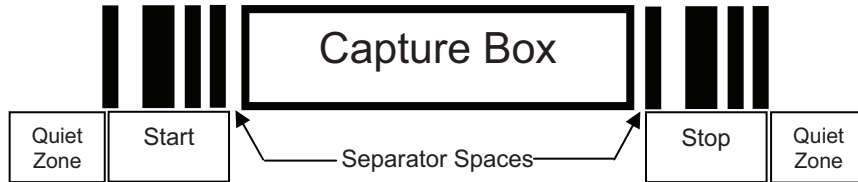

Figure J-2 CapCode Structure

The separator spaces on either side of the signature capture box can be between $1X$ and $3X$ wide.

Start / Stop Patterns

[Table J-1](#) lists the accepted start / stop patterns. The bar and space widths are expressed as multiples of X . You must use the same pattern on either side of a signature capture box. The type value is reported with the captured signature to indicate the purpose of the signature captured.

Table J-1 Start / Stop Pattern Definitions

Bar/Space Patterns							Type
B	S	B	S	B	S	B	
1	1	2	2	1	1	1	2
1	2	2	1	1	1	1	5
2	1	1	2	1	1	1	7
2	2	1	1	1	1	1	8
3	1	1	1	1	1	1	9

[Table J-2](#) lists selectable parameters used to generate the image of the captured signature.

Table J-2 *User Defined CapCode Parameters*

Parameter	Defined
Width	Number of pixels
Height	Number of pixels
Format	JPEG, BMP, TIFF
JPEG quality	1 (most compression) to 100 (best quality)
Bits Per Pixel (not applicable to JPEG format)	1 (2 levels)
	4 (16 levels)
	8 (256 levels)

BMP format does not use compression, JPEG and TIFF formats do.

Dimensions

The size of the signature capture box is determined by the height and separation of the start and stop patterns. The line width of the signature capture box is insignificant.

The thinnest element width, referred to here as X, is nominally 10 mils (1 mil = 0.0254 mm). Select this as an exact multiple of the pixel pitch of the printer used. For example, when using a 203 DPI (dots-per-inch) printer and printing 2 dots per module, the resulting X dimension is 9.85 mils.

Data Format

The decoder output is formatted according to [Table J-3](#). Zebra decoders allow different user options to output or inhibit bar code type. Selecting "Symbol ID" as the bar code type for output identifies the CapCode with letter "i".

Table J-3 *Data Format*

File Format (1 byte)	Type (1 byte)	Image Size (4 bytes, BIG Endian)	Image Data
JPEG - 1 BMP - 3 TIFF - 4	See Table J-1 , last column		(Same bytes as in a data file)

Additional Capabilities

Regardless of how the signature is captured, the output signature image is de-skewed and right-side up.

A scanner that captures signatures automatically determines whether it is scanning a signature or a bar code. You can disable the signature capturing capability in a decoder.

Signature Boxes

Figure J-3 illustrates the five acceptable signature boxes:

Type 2:



Type 5:



Type 7:



Type 8:



Type 9:



Figure J-3 *Acceptable Signature Boxes*

APPENDIX K NON-PARAMETER ATTRIBUTES (ATTRIBUTE DATA DICTIONARY)

Introduction

This appendix defines non-parameter attributes.

Attributes

Model Number

Attribute #533

Model number of the scanner. This electronic output matches the printout on the physical device label, for example **DS8108-SR00007ZZWW**.

Type	S
Size (Bytes)	18
User Mode Access	R
Values	Variable

Serial Number

Attribute #534

Unique serial number assigned in the manufacturing facility. This electronic output matches the printout on the physical device label, for example **M1J26F45V**.

Type	S
Size (Bytes)	16
User Mode Access	R
Values	Variable

Date of Manufacture

Attribute #535

Date of device manufacture assigned in the manufacturing facility. This electronic output matches the printout on the physical device label, for example **31MAR17** (which reads the 31st of March 2017).

Type	S
Size (Bytes)	7
User Mode Access	R
Values	Variable

Date of First Programming

Attribute #614

Date of first electronic programming represents the first time settings were electronically loaded to the scanner either by 123Scan or via SMS, for example **18MAY17** (which reads the 18th of May 2017).

Type	S
Size (Bytes)	7
User Mode Access	R
Values	Variable

Configuration Filename

Attribute #616

The name assigned to the configuration settings loaded electronically to the device either by 123Scan or via SMS.



NOTE Scanning the **Set Defaults** bar code automatically changes the configuration filename to *factory defaults*.

To indicate the configuration settings loaded to the device were changed, the configuration filename changes to *Modified* upon scanning any parameter bar code.

Type	S
Size (Bytes)	17
User Mode Access	RW
Values	Variable

Beeper/LED**Attribute #6000**

Activates the beeper and/or LED.

Type	X
Size (Bytes)	N/A
User Mode Access	W

Values:

Beep / LED Action	Value
1 high short beep	0
2 high short beeps	1
3 high short beeps	2
4 high short beeps	3
5 high short beeps	4
1 low short beep	5
2 low short beeps	6
3 low short beeps	7
4 low short beeps	8
5 low short beeps	9
1 high long beep	10
2 high long beeps	11
3 high long beeps	12
4 high long beeps	13
5 high long beeps	14
1 low long beep	15
2 low long beeps	16
3 low long beeps	17
4 low long beeps	18
5 low long beeps	19
Fast warble beep	20
Slow warble beep	21
High-low beep	22
Low-high beep	23
High-low-high beep	24
Low-high-low beep	25
High-high-low-low beep	26
Green LED off	42
Green LED on	43
Red LED on	47
Red LED off	48

Parameter Defaults

Attribute #6001

This attribute restores all parameters to their factory defaults.

Type	X
Size (Bytes)	N/A
User Mode Access	W
Values	0 = Restore Defaults 1 = Restore Factory Defaults 2 = Write Custom Defaults

Beep on Next Bootup

Attribute #6003

This attribute configures (enables or disables) beep on next boot up of scanner.

Type	X
Size (Bytes)	N/A
User Mode Access	W
Values	0 = Disable beep on next bootup 1 = Enable beep on next bootup

Reboot

Attribute #6004

This attribute initiates a device reboot.

Type	X
Size (Bytes)	N/A
User Mode Access	W
Values	N/A

Host Trigger Session

Attribute #6005

This attribute triggers a decode session similar to manually depressing the scanner trigger button.

Type	X
Size (Bytes)	N/A
User Mode Access	W
Values	1 = Start Host Trigger Session 0 = Stop Host Trigger Session

Firmware Version

Attribute #20004

The scanner's operating system version. For example, **NBRFMAAC** or **PAAAABS00-007-R03D0**.

Type	S
Size (Bytes)	Variable
User Mode Access	R
Values	Variable

Scankit Version

Attribute #20008

Identifies the 1D decode algorithms resident on the device, for example **SKIT4.33T02**.

Type	S
Size (Bytes)	Variable
User Mode Access	R
Values	Variable

ScanSpeed Analytics

Identifies problematic bar codes to speed up scanning processes.

Zebra ScanSpeed Analytics software allows you to visually identify bar codes that slow down processing and impact efficiency. Over time, the software collects data that you can use to eliminate poor performing bar codes from inventory. For more information go to zebra.com/scanspeedanalytics.

APPENDIX L SAMPLE BAR CODES

UPC/EAN

UPC-A, 100%

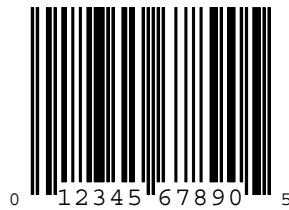

UPC-A with 2-digit Add-on

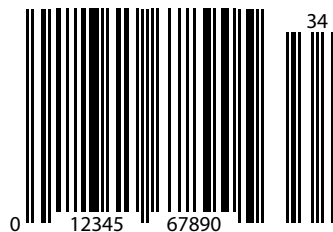

UPC-A with 5-digit Add-on



UPC-E



UPC-E with 2-digit Add-on



UPC/EAN (continued)

UPC-E with 5-digit Add-on



EAN-8



EAN-13, 100%

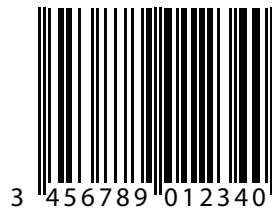

EAN-13 with 2-digit Add-on



EAN-13 with 5-digit Add-on



Code 128



GS1-128

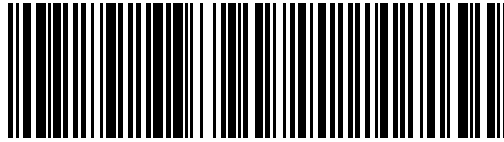

(01)94019097685457(13)170119(30)17

Code 39

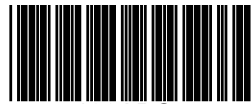

123ABC

Code 93

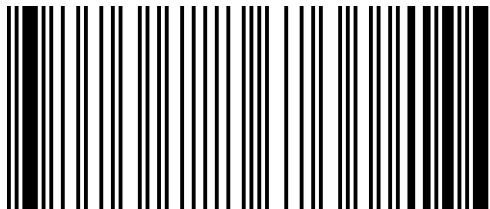

1234567890

Code 11 with 2 Check Digits



Interleaved 2 of 5



MSI with 2 Check Digits

✓ **NOTE** MSI must be enabled to read the following bar code (see *MSI* on page 12-65).



Chinese 2 of 5

✓ **NOTE** Chinese 2 of 5 must be enabled to read the following bar code (see *Chinese 2 of 5* on page 12-70).

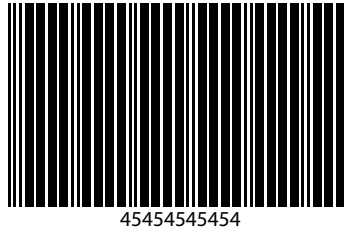

Matrix 2 of 5

✓ **NOTE** Matrix 2 of 5 must be enabled to read the following bar code (see *Matrix 2 of 5* on page 12-71).



Korean 3 of 5

✓ **NOTE** Korean 2 of 5 must be enabled to read the following bar code (see *Korean 3 of 5* on page 12-74).



GS1 DataBar

GS1 DataBar Omnidirectional (formerly GS1 DataBar-14)



7612341562341

GS1 DataBar Truncated

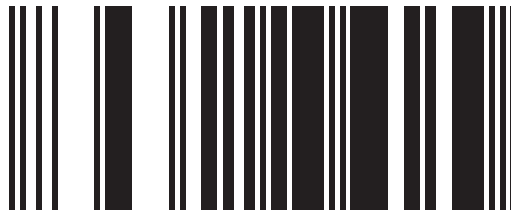

(01)0061414199996

GS1 DataBar Stacked



GS1 DataBar Stacked Omnidirectional



GS1 DataBar Limited



GS1 DataBar Expanded



GS1 DataBar (continued)

GS1 DataBar Expanded Stacked



2D Symbolologies

PDF417



2D Symbologies (continued)

Data Matrix



GS1 Data Matrix

✓ **NOTE** GS1 Data Matrix must be enabled to read the following bar code (see *GS1 Data Matrix* on page 12-92).



Maxicode

✓ **NOTE** Maxicode must be enabled to read the following bar code (see *Maxicode* on page 12-95).

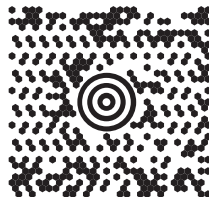

2D Symbologies (continued)

QR Code



GS1 QR



NOTE GS1 QR must be enabled to read the following bar code (see *GS1 QR* on page 12-96).



MicroQR



2D Symbologies (continued)

Aztec



0123456789ABCDEFGHIJKLMNOPQRSTUVWXYZ0123456789ABCDEFGHIJKLMNOPQRSTUVWXYZ0123456789012345
6789ABCDEFGHIJKLMNOPQRSTUVWXYZ0123456789ABCDEFGHIJKLMNOPQRSTUVWXYZ0123456789

Han Xin



NOTE Han Xin must be enabled to read the following bar code (see *Han Xin* on page 12-101).



Grid Matrix



NOTE Grid Matrix must be enabled to read the following bar code (see *Grid Matrix* on page 12-103).

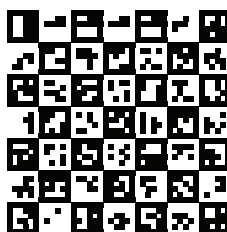

Postal Codes

US Postnet

✓ **NOTE** US Postnet must be enabled to read the following bar code (see *US Postnet on page 12-110*).



UK Postal

✓ **NOTE** UK Postal must be enabled to read the following bar code (see *UK Postal on page 12-111*).



Japan Postal

✓ **NOTE** Japan Postal must be enabled to read the following bar code (see *Japan Postal on page 12-112*).



Postal Codes (continued)

Australian Post

✓ **NOTE** Australia must be enabled to read the following bar code (see *Australia Post on page 12-113*).



OCR

✓ **NOTE** OCR must be enabled to read the following bar codes (see *OCR Programming Parameters on page 13-3*).

OCR-A

WFSGH67890

OCR-B

12345ABMKP

APPENDIX M SCAN SPEED ANALYTICS

Introduction

This appendix describes the Zebra ScanSpeed Analytics software that allows the identification of bar codes that slow down processes. Over time, the collected data can be used to eliminate poor performing bar codes from inventory. When scanners capture and read data faster, processes run faster.

For more information go to zebra.com/scanspeedanalytics.

Histogram Decode Information

Within the scanner, each bar code symbology has a series of RSM attributes (*Table M-1*) to access its statistic information: Decode Count; Minimum Decode Time; Slowest Decode Time; Average Decode Time; Slowest Decode Data; and, ScanSpeed Histogram.

ScanSpeed Histogram is an array of eight items of double WORD (4 bytes). Each bin holds the count of decoded bar codes per range of decode time. For example, the range of Bin1 decode times is from 0 ms to 75 ms. All the Bin time ranges are show below:

- Bin1 <= 75ms
- Bin2 <= 110ms
- Bin3 <= 170ms
- Bin4 <= 300ms
- Bin5 <= 600ms
- Bin6 <= 1000ms
- Bin7 <= 1500ms
- Bin8 > 1500ms

123Scan displays this histogram data in its Statistics tab shown in *Figure M-1 on page M-2*.

M - 2 DS8108 Digital Scanner Product Reference Guide

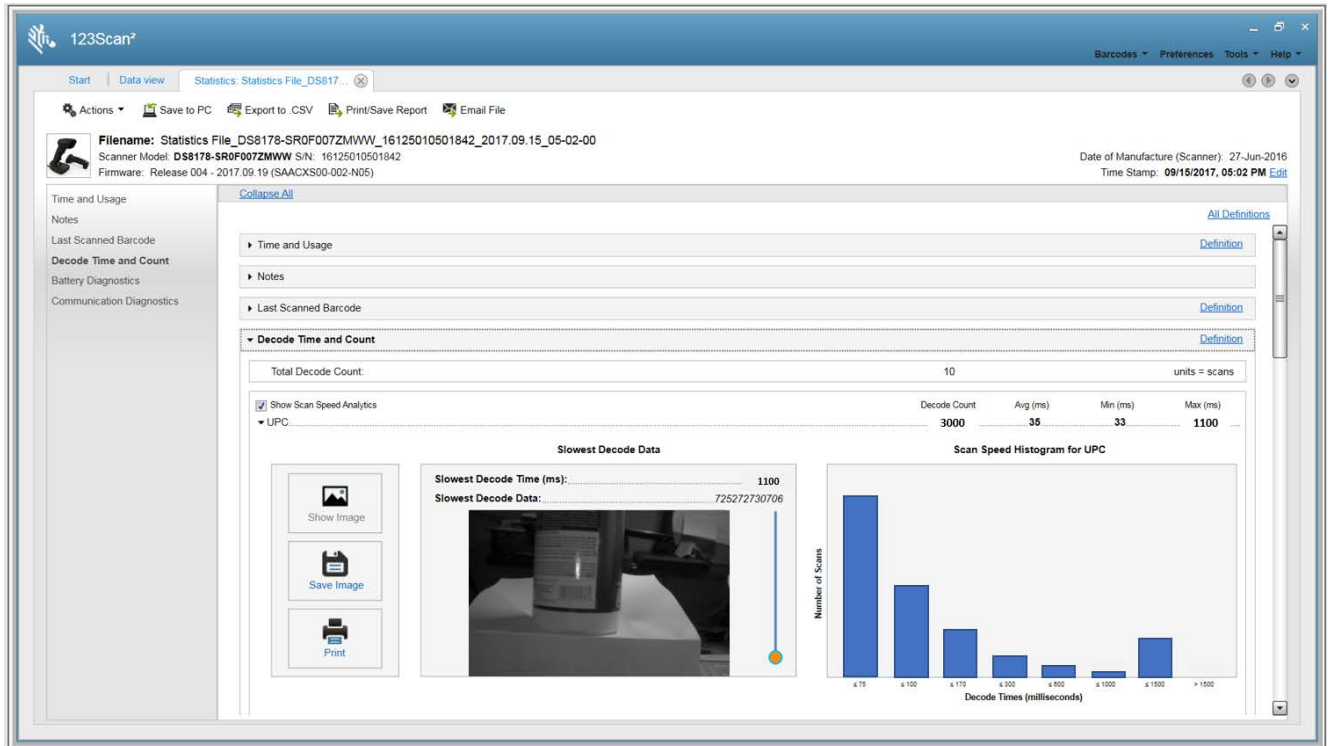

Figure M-1 123Scan Statistics Tab - Histogram Data

Table M-1 Attributes Numbers of Bar Code Symbology Statistic Information

Bar Code Name	Decode Count		Minimum Decode Time	Slowest Decode Time (Max Decode Time)	Average Decode Time	Slowest Decode Data	ScanSpeed Histogram
	Decimal Value	Hex Value (Shown in Little Endian Format)					
UPC	15421	0x3D, 0x3C	15424	15425	15426	15707	15706
EAN/JAN	15428	0x44, 0x3C	15431	15432	15433	15709	15708
2 of 5	15449	0x59, 0x3C	15452	15453	15454	15715	15714
Codabar	15456	0x60, 0x3C	15459	15460	15461	15717	15716
Code 11	15477	0x75, 0x3C	15480	15481	15482	15723	15722
Code 128	15442	0x52, 0x3C	15445	15446	15447	15713	15712
Code 39	15435	0x4B, 0x3C	15438	15439	15440	15711	15710
Code 93	15463	0x67, 0x3C	15466	15467	15468	15719	15718
Composite	15519	0x9F, 0x3C	15522	15523	15524	15735	15734
GS1 DataBar	15512	0x98, 0x3C	15515	15516	15517	15733	15732
MSI	15470	0x6E, 0x3C	15473	15474	15475	15721	15720
Data Matrix	15491	0x83, 0x3C	15494	15495	15496	15727	15726

Table M-1 Attributes Numbers of Bar Code Symbology Statistic Information (Continued)

Bar Code Name	Decode Count		Minimum Decode Time	Slowest Decode Time (Max Decode Time)	Average Decode Time	Slowest Decode Data	ScanSpeed Histogram
	Decimal Value	Hex Value (Shown in Little Endian Format)					
PDF	15484	0x7C, 0x3C	15487	15488	15489	15725	15724
Postal Codes	15505	0x91, 0x3C	15508	15509	15510	15731	15730
QR	15498	0x8A, 0x3C	15501	15502	15503	15729	15728
Aztec	15533	0xAD, 0x3C	15536	15537	15538	15739	15738
OCR	15526	0xA6, 0x3C	15529	15530	15531	15737	15736
Maxicode	15659	0x2B, 0x3D	15662	15663	15664	15755	15754
GS1-Data Matrix	15673	0x39, 0x3D	15676	15677	15678	15747	15746
GS1-QR Code	15680	0x40, 0x3D	15683	15684	15685	15749	15748
Coupon	15666	0x32, 0x3D	15669	15670	15671	15757	15756
Other 1D	15540	0xB4, 0x3C	15543	15544	15545	15741	15740
Other 2D	15547	0xBB, 0x3C	15550	15551	15552	15743	15742
Other	15554	0xC2, 0x3C	15557	15558	15559	15745	15744
Unused Statistic ID	19999	0x1F, 0x4E	19999	19999	19999	19999	19999

Example

The UPC data below is taken from the first row of [Table M-1](#) above.

UPC DECODE COUNT

Attribute #: 15421

Type: DWORD (4 bytes)

Description: Returns the UPC bar code decode count, including all variants (UPC-A, UPC-E, UPC-E1, etc.).

UPC MINIMUM DECODE TIME

Attribute #: 15424

Type: DWORD (4 bytes)

Description: Returns the Minimum Decode Time in milliseconds of all UPC bar code decodes.

UPC SLOWEST DECODE TIME

Attribute #: 15425

Type: DWORD (4 bytes)

Description: Returns the Slowest Decode Time in milliseconds of all UPC bar code decodes.

UPC AVERAGE DECODE TIME

Attribute #: 15426

Type: DWORD (4 bytes)

Description: Returns the Average Decode Time in milliseconds of all UPC bar code decodes.

UPC SLOWEST DECODE DATA

Attribute #: 15707

Type: Array of BYTE (25 bytes)

Description: Returns the UPC bar code data with the Slowest Decode Time.

UPC SCAN SPEED HISTOGRAM

Attribute #: 15706

Type: Array of DWORD (32 bytes)

Description: Returns the UPC bar code ScanSpeed Histogram.

Image of Slowest Decoded Bar Code

The user can configure the scanner to store the image(s) of the slowest decoded bar code.

Table M-2 RSM Attributes to Store/Retrieve Image of Slowest Decoded Bar Code

Attribute #	Type	Property	Default Value	Description
1755	Array of WORD	RW	Default format = {0x1F, 0x4E} 0x1F, 0x4E No image retained Bar code name = Unused Statistic ID Decimal value = 19999 see last row in Table M-1 on page M-2 0x3D, 0x3C Image retained for UPC Decimal value = 15421 Sample image retained for UPC only = {0x3D, 0x3C}	Attribute 1755 is named List of Stored Images. This attribute defines which image, by symbology, of the slowest decoded bar code will be stored in the scanner. One symbology image can be stored in the scanner. Note: {0x1F, 0x4E} = a 1 WORD value which is in little-endian format.
1756	WORD	RW	0	Attribute 1756 is named Threshold To Store Slowest Decode Bar Code Image. This attribute defines the threshold above which the scanner stores the image of the slowest decoded bar code. Specify a Histogram Bin value (0, 1, 2, 3, 4, 5, 6 or 7). The purpose of setting up this threshold is to reduce the bar code image storage frequency. 0 - No threshold check (default value) 1 - Specifies the decode time threshold as Histogram Bin 1 value of 75 ms Similarly, the other Histogram Bins specify the corresponding threshold time as follows: Bin 1 <= 75ms Bin 2 <= 110ms Bin 3 <= 170ms Bin 4 <= 300ms Bin 5 <= 600ms Bin 6 <= 1000ms Bin 7 <= 1500ms

Table M-2 RSM Attributes to Store/Retrieve Image of Slowest Decoded Bar Code (Continued)

Attribute #	Type	Property	Default Value	Description
6036	WORD	WO	N/A	<p>Attribute 6036 is named Retrieve Slowest Decoded Bar Code Image.</p> <p>The image must be retrieved using the SNAPi communication protocol.</p> <p>This attribute allows you to retrieve from the scanner a single image, by symbology, of the slowest decoded data.</p> <p>For example, to retrieve the slowest decoded bar code image for a UPC symbology, enter its hex value, 0x3D, 0x3C (decimal value 15421), using a SET command.</p> <p>See Table M-1 on page M-2 for symbology hex and decimal values.</p>

INDEX

Numerics

123Scan	
overview	2-1
requirements	2-2
videos/tools	
SDKs, drivers, apps	2-3
URLs	2-2
2D bar codes	
aztec	12-99
aztec inverse	12-100
code 128 emulation	12-91
data matrix	12-92
data matrix inverse	12-93
data matrix mirror images	12-94
grid matrix	12-103
grid matrix inverse	12-103
grid matrix mirror	12-104
GS1 data matrix	12-92
GS1 QR	12-96
han xin	12-101
han xin inverse	12-102
linked QR mode	12-98
maxicode	12-95
microPDF417	12-90
microQR	12-97
PDF417	12-90
QR code	12-96

A

AAMVA field parsing	17-7
accessories	
EAS	3-14
interface cable	1-2
power supply	1-2
shielded cables	1-3

ADF	16-1
invalid rule	4-6
transmit error	4-6
ADF programming indicators	3-2
advanced data formatting	4-6, 16-1
aiming	
orientation	3-7
pattern, hand-held	10-23
pattern, hands-free	10-24
pattern, snapshot	11-9
snapshot mode timeout	11-8
video view finder	11-23
aiming pattern	3-7
orientation	3-8
ASCII character sets	D-1
assembling the stand	3-4
attributes	
non-parameter	M-1
attributes, non-parameter	K-1
beep on next bootup	K-4
configuration filename	K-2
date of first programming	K-2
date of manufacture	K-2
firmware version	K-5
host trigger session	K-4
model number	K-1
parameter defaults	K-4
reboot	K-4
scankit version	K-5
scanspeed analytics	K-5
serial number	K-1
autoexposure	11-5
aztec bar codes	12-99
inverse	12-100
sample	L-13

B

bar codes

- 1D quiet zone level 12-84
- alphanumeric C-2
- autoexposure 11-5
- aztec 12-99
 - inverse 12-100
- beep after good decode 10-6
- beeper duration 10-9
- beeper tone 10-8
- beeper volume 10-7
- bits per pixel 11-18
- cancel B-3, C-1
- Chinese 2 of 5 12-70
- CJK
 - non-CJK UTF bar code output I-5
 - output method I-3
 - unicode output control I-2
- codabar 12-60
 - CLSI editing 12-62
 - lengths 12-60
 - NOTIS editing 12-62
 - start and stop characters 12-64
- codabar security level 12-63
- code 11 12-48
 - check digit verification 12-50
 - lengths 12-48
 - transmit check digits 12-51
- code 128 12-29
 - check ISBT table 12-33
 - code 128 fnc4 12-34
 - GS1-128 12-31
 - ISBT 128 12-31
 - ISBT concatenation 12-32
 - ISBT concatenation redundancy 12-33
 - lengths 12-29
 - reduced quiet zone 12-37
 - security level 12-35
- code 128 emulation 12-91
- code 39 12-38
 - check digit verification 12-41
 - code 32 prefix 12-39
 - convert code 39 to code 32 12-39
 - full ASCII conversion 12-42
 - lengths 12-40
 - reduced quiet zone 12-45
 - security level 12-43
 - transmit check digit 12-42
 - trioptic code 39 12-38
- code 93 12-46
 - lengths 12-46
- composite
 - beep mode 12-89
 - composite CC-A/B 12-86
 - composite CC-C 12-86
 - composite inverse 12-87
 - composite TLC-39 12-87
 - GS1-128 emulation mode 12-89
 - UPC composite mode 12-88
- continuous bar code read 10-26
- country code page defaults H-1
- country code pages H-5
- country codes G-2
- country keyboard types (country codes) G-2
- crop to address 11-10
- data matrix 12-92
 - data matrix inverse 12-93
 - GS1 data matrix 12-92
 - mirror images 12-94
- decode pager motor 10-12
- decode pager motor duration 10-13
- decode session timeout 10-27
- digimarc digital watermarks/dw 15-2
- direct decode indicator 10-11
- disable all code types 12-9
- discrete 2 of 5 12-58
 - lengths 12-58
- driver's license parsing 17-2
 - AAMVA field parsing 17-7
 - driver's license date format 17-18
 - driver's license gender format 17-17
 - no separator 17-19
 - parser version ID 17-17
 - parsing field 17-4
 - send control characters 17-20
 - send keyboard characters 17-24
 - set defaults 17-17
- dump scanner parameters 4-7
- enable all code types 12-9
- enter 10-34
- fixed exposure 11-6
- fixed gain 11-6
- FN1 substitution values 10-39
- gain and exposure priority for snapshot mode 11-7
- grid matrix 12-103
- grid matrix inverse 12-103
- grid matrix mirror 12-104
- GS1 databar 12-76
 - convert to UPC/EAN/JAN 12-78
 - GS1 databar expanded 12-77
 - GS1 databar limited 12-77
 - GS1 databar limited margin check 12-80
 - GS1 databar omnidirectional 12-76
 - security level 12-79
- han xin 12-101
 - inverse 12-102
- hand-held decode aiming pattern 10-23

- hand-held trigger mode 10-21
- hands-free decode aiming pattern 10-24
- hands-free decode session timeout 10-27
- hands-free mode 10-22
- IBM
 - bar code configuration directive 8-6
 - beep directive 8-5
 - convert unknown to code 39 8-5
 - default table 8-3
 - IBM specification version 8-6
 - port address 8-4
- IDC
 - aspect 14-11
 - bits per pixel 14-12
 - border type 14-16
 - captured image brighten 14-14
 - captured image sharpen 14-15
 - default table 14-5
 - delay time 14-17
 - file format selector 14-11
 - find box outline 14-13
 - height 14-10
 - JPEG quality 14-12
 - maximum rotation 14-18
 - maximum text length 14-14
 - minimum text length 14-13
 - operating mode 14-7
 - symbology 14-8
 - width 14-10
 - X coordinate 14-9
 - Y coordinate 14-9
 - zoom limit 14-17
- illumination 10-32, 11-5
- illumination brightness 10-33
- image brightness (target white) 11-13
- image capture
 - default table 11-2
- image cropping 11-10
- image enhancement 11-15
- image file format 11-16
- image rotation 11-17
- image size 11-12
- intercharacter gap size 12-85
- interleaved 2 of 5 12-52
 - check digit verification 12-54
 - convert to EAN-13 12-55
 - lengths 12-52
 - reduced quiet zone 12-57
 - security level 12-56
 - transmit check digit 12-55
- inverse 1D 12-75
- JPEG image options 11-13
- JPEG quality 11-14
- JPEG size 11-14
- keyboard wedge
 - alternate numeric keypad emulation 9-6
 - caps lock override 9-7
 - convert case 9-8
 - default table 9-3
 - FN1 substitution 9-9
 - function key mapping 9-8
 - host types 9-4
 - intra-keystroke delay 9-5
 - keystroke delay 9-5
 - quick keypad emulation 9-6
 - send make and break 9-9
 - simulated caps lock 9-7
 - unknown characters 9-4
- Korean 3 of 5 12-74
- LED on good decode 10-10
- linked QR mode 12-98
- low power mode 10-18
- macro PDF
 - abort entry 12-109
 - flush buffer 12-109
- manufacturing information 4-8
- matrix 2 of 5 12-71
 - check digit 12-73
 - lengths 12-71
 - transmit check digit 12-73
- maxicode 12-95
- microPDF417 12-90
- mobile phone/display mode 10-30
- motion tolerance 10-34
- MSI 12-65
 - check digit algorithm 12-69
 - check digits 12-67
 - lengths 12-65
 - reduced quiet zone 12-69
 - transmit check digit 12-67
- night mode 10-14
- night mode silence parameter programming beeper
 - indications 10-16
- night mode toggle 10-15
- night mode trigger 10-15
- numeric B-1
- numeric bar codes B-3
- OCR
 - check digit 13-25
 - check digit multiplier 13-26
 - check digit validation 13-27
 - default table 13-2
 - inverse OCR 13-32
 - lines 13-13
 - maximum characters 13-14
 - MICR E13B 13-10
 - minimum character 13-13
 - OCR-A 13-3

- OCR-A variant 13-4
- OCR-B 13-5
- OCR-B variant 13-6
- orientation 13-11
- parameters 13-3
- quiet zone 13-15
- redundancy 13-33
- subset 13-14
- template 13-15
- US currency serial number 13-11
- operational modes 11-4
- pager motor 10-12
- parameter scanning 10-6
- PDF prioritization 10-31
- PDF prioritization timeout 10-31
- PDF417 12-90
- picklist mode 10-25
- postal 12-110
 - Australia post 12-113
 - Australia post format 12-114
 - Japan postal 12-112
 - mailmark 12-116
 - Netherlands KIX code 12-115
 - transmit UK postal check digit 12-112
 - transmit US postal check digit 12-111
 - UK postal 12-111
 - UPU FICS postal 12-116
 - US planet 12-110
 - US postnet 12-110
 - USPS 4CB/One Code/Intelligent Mail 12-115
- prefix/suffix values 10-36
- presentation mode field of view 10-32
- QR code 12-96
 - GS1 QR 12-96
 - microQR 12-97
- redundancy level 12-81
- RS-232
 - baud rate 7-9
 - beep on bel 7-17
 - check receive errors 7-12
 - data bits 7-11
 - default table 7-3
 - hardware handshaking 7-12
 - host serial response timeout 7-16
 - host types 7-7
 - intercharacter delay 7-18
 - nixdorf beep LED options 7-19
 - parity 7-10
 - RTS line state 7-17
 - software handshaking 7-14, 7-15
 - stop bits 7-11
 - unknown characters 7-19
- samples L-1
- scan data options 10-37
- securePharm 10-42, 10-43
- security level 12-83
- send versions 4-8
- serial number 4-8
- set defaults 10-5
- signature capture 11-19
- signature capture bits per pixel 11-21
- signature capture file format 11-20
- signature capture height 11-22
- signature capture JPEG quality 11-22
- signature capture width 11-22
- silence operational mode changes 11-9
- snapshot aiming pattern 11-9
- snapshot mode timeout 11-8
- software version 4-8
- SSI
 - baud rate 6-12
 - boot up event 6-23
 - check parity 6-14
 - data packet format 6-17
 - decode event 6-22
 - host character timeout 6-19
 - host RTS line state 6-17
 - host serial response timeout 6-18
 - interpacket delay 6-21
 - multipacket option 6-20
 - parameter event 6-23
 - parity 6-13
 - selecting 6-12
 - software handshaking 6-16
 - stop bits 6-15
- suppress power up beeps 10-10
- symbolologies
 - default table 12-2
- tab key 10-34
- time delay to low power mode 10-19
- timeout between decodes, different symbols 10-28
- timeout between decodes, same symbol 10-28
- transmit code ID character 10-35
- transmit no read message 10-40
- triggered timeout, same symbol 10-29
- unique bar code reporting 10-26
- unsolicited heartbeat interval 10-41
- UPC/EAN/JAN
 - bookland EAN 12-12
 - bookland ISBN 12-13
 - convert UPC-E to UPC-A 12-25
 - convert UPC-E1 to UPC-A 12-25
 - coupon report 12-27
 - EAN/JAN zero extend 12-26
 - EAN-13/JAN-13 12-12
 - EAN-8/JAN-8 12-11
 - ISSN EAN 12-14
 - supplemental AIM ID format 12-19

supplemental redundancy	12-18
supplementals	12-15
transmit UPC-A check digit	12-20
transmit UPC-E check digit	12-20
transmit UPC-E1 check digit	12-21
UCC coupon extended code	12-26
UPC reduced quiet zone	12-28
UPC-A	12-10
UPC-A preamble	12-22
UPC-E	12-10
UPC-E preamble	12-23
UPC-E1	12-11
UPC-E1 preamble	12-24
user programmable supplementals	12-18
USB	
bar code configuration directive	5-22
beep directive	5-21
caps lock override	5-9
CDC host variant	5-18
convert case	5-17
convert unknown to code 39	5-10
default table	5-4
device type	5-6
direct I/O beep	5-21
fast HID	5-11
function key mapping	5-16
IBM specification version	5-22
keyboard FN1 substitution	5-15
keypad emulation	5-14
keypad emulation with leading zero	5-15
keystroke delay	5-8
polling interval	5-12
quick keypad emulation	5-14
simulated caps lock	5-16
SNAPI handshaking	5-8
static CDC	5-17
unknown characters	5-9
user preferences	
default table	10-2
video image size	11-23
video view finder	11-23
battery definitions	3-2
beeper	
beep after good decode	10-6
definitions	3-2
duration	10-9
suppress on power up	10-10
tone adjustment	10-8
beeper indicators	
ADF programming	3-2
host specific	3-3
parameter programming	3-2
scanning	3-2
standard	3-2

C

cable configurations	xxii
cables	xxii
installing	1-3
interface	1-2
removing	1-4
shielded	1-3
signal descriptions	4-12
CDC host variant	5-18
character sets	
ALT key	D-6
ASCII	D-1
extended key	D-12
F key	D-10
GUI key	D-7
numeric key	D-11
PF key	D-9
Chinese 2 of 5 bar codes	12-70
sample	L-7
CJK	I-1
control parameters	I-2
country keyboard missing characters	I-6
decode setup	I-7
input method	I-8
cleaning the devices	
approved disinfectant cleaners for healthcare devices	4-2
approved for standard devices	4-2
how to	4-3
known harmful ingredients	4-2
codabar bar codes	12-60
CLSI editing	12-62
lengths	12-60
NOTIS editing	12-62
security level	12-63
start and stop characters	12-64
code 11 bar codes	12-48
check digit verification	12-50
lengths	12-48
sample	L-6
transmit check digits	12-51
code 128 bar codes	12-29
check ISBT table	12-33
fnc4	12-34
GS1-128	12-31
ISBT 128	12-31
ISBT concatenation	12-32
ISBT concatenation redundancy	12-33
lengths	12-29
reduced quiet zone	12-37
sample	L-4
security level	12-35
code 128 emulation bar codes	12-91

- code 39 bar codes 12-38
 - check digit verification 12-41
 - code 32 prefix 12-39
 - code 39 security level 12-43
 - convert code 39 to code 32 12-39
 - full ASCII conversion 12-42
 - lengths 12-40
 - reduced quiet zone 12-45
 - sample L-1, L-5
 - transmit check digit 12-42
 - trioptic 12-38
 - code 93 bar codes 12-46
 - lengths 12-46
 - sample L-5
 - code identifiers
 - AIM E-3
 - modifier characters E-4
 - Symbol E-1
 - transmitting 10-35
 - communication protocol
 - cable interface F-1
 - composite bar codes
 - beep mode 12-89
 - composite CC-A/B 12-86
 - composite CC-C 12-86
 - composite inverse 12-87
 - composite TLC-39 12-87
 - GS1-128 emulation mode 12-89
 - UPC composite mode 12-88
 - configurationsxxi
 - cables xxii
 - product line xxii
 - connecting
 - IBM interface 8-2
 - interface cable 1-3
 - keyboard wedge interface 9-2
 - power 1-4
 - RS-232 interface 7-2
 - USB interface 5-2
 - conventions
 - notationalxxiv
 - country code pages H-5
 - defaults H-1
 - country codes G-2
 - cropping images 11-10
- D**
- data matrix bar codes 12-92
 - data matrix inverse 12-93
 - GS1 data matrix 12-92
 - mirror images 12-94
 - sample L-11, L-12, L-13, L-14, L-15
 - decode ranges
 - ds8108-hc 3-10
 - ds8108-sr/dl 3-9
 - default parameters 10-2
 - all A-1
 - DL parsing 17-1
 - IBM 8-3
 - IDC 14-5
 - image capture 11-2
 - keyboard wedge 9-3
 - OCR 13-2
 - RS-232 7-3
 - setting 10-5
 - SSI 6-11
 - USB 5-4
 - user preferences 10-2
 - digimarc digital watermarks/dw 15-2
 - digital scanner
 - parts 3-1
 - discrete 2 of 5 bar codes 12-58
 - lengths 12-58
 - driver's license parsing
 - AAMVA field parsing 17-7
 - ADF example 17-43
 - bar codes 17-2
 - control characters 17-20
 - data fields 17-3
 - date format 17-18
 - default parameters 17-1
 - field parsing bar codes 17-4
 - gender format 17-17
 - keyboard characters 17-24
 - no separator 17-19
 - parser version ID 17-17
 - rule example 17-39
- E**
- EAS 3-14
 - error indications
 - ADF 4-6
 - format 4-7
 - input 4-6
 - exposure options
 - autoexposure 11-5
 - fixed exposure 11-6
 - fixed gain 11-6
 - gain and exposure priority for snapshot mode 11-7
 - illumination 10-32, 11-5
 - presentation mode field of view 10-32
- G**
- gooseneck Intellistand 3-4, 3-6
 - grid matrix bar codes

sample	L-13
gs1 data matrix bar codes	
sample	L-11
GS1 databar bar codes	12-76
convert GS1 databar to UPC/EAN/JAN	12-78
GS1 databar expanded	12-77
GS1 databar limited	12-77
GS1 databar limited margin check	12-80
GS1 databar omnidirectional	12-76
sample	L-8
security level	12-79
GS1 QR bar codes	
sample	L-12

H

han xin bar codes	12-101
inverse	12-102
sample	L-13
host specific indicators	3-3
host types	
IBM	8-4
keyboard wedge	9-4
RS-232	7-7
SSI	6-12
USB	5-6

I

IBM	
bar codes	8-4
connection	8-2
default parameters	8-3
IDC	14-1
bar code acceptance test	14-2
bar codes	14-7
capture region	14-2
data transmission	14-3
default parameters	14-5
demonstrations	14-20
image post processing	14-3
operating mode	14-3
quick start	14-19
quick start form	14-21
sample setup	14-19
support	14-3
illumination	10-32, 11-5
brightness	10-33
image capture	
default parameters	11-2
operational modes	11-4
image options	
bits per pixel	11-18
cropping	11-10

file formats	11-16
image brightness (target white)	11-13
image enhancement	11-15
image rotation	11-17
image size	11-12
JPEG image options	11-13
JPEG quality	11-14
JPEG size	11-14
signature capture	11-19
signature capture file format	11-20
information, service	. xxv
interleaved 2 of 5 bar codes	12-52
check digit verification	12-54
convert to EAN-13	12-55
lengths	12-52
reduced quiet zone	12-57
sample	L-6
security level	12-56
transmit check digit	12-55

J

JPEG image options	11-13
quality	11-14
size	11-14

K

keyboard types (country codes)	
Albanian	G-2
Arabic (101)	G-2
Arabic (102)	G-3
Arabic (102) Azerty	G-3
Azeri (Cyrillic)	G-3
Azeri (Latin)	G-3
Belarusian	G-3
Bosnian (Cyrillic)	G-3
Bosnian (Latin)	G-3
Bulgarian (Latin)	G-4
Bulgarian Cyrillic (Typewriter)	G-4
Canadian French (Legacy)	G-4
Canadian French Win7	G-4
Canadian Multilingual Standard	G-4
Chinese (ASCII)	G-4
Chinese (Simplified)	G-5
Chinese (Traditional)	G-5
Croatian	G-5
Czech	G-5
Czech (Programmer)	G-5
Czech (QWERTY)	G-5
Danish	G-5
Dutch (Netherlands)	G-6
Estonian	G-6
Faeroese	G-6

Finnish	G-6	Spanish (Variation)	G-14
French (Canada) 2000/XP	G-7	Swedish	G-14
French (Canada) 95/98	G-6	Swiss French	G-14
French (France)	G-6	Swiss German	G-14
French International	G-6	Tatar	G-15
Galician	G-7	Thai (Kedmanee)	G-15
German	G-7	Turkish F	G-15
Greek	G-7	Turkish Q	G-15
Greek (220) Latin	G-7	UK English	G-15
Greek (319) Latin	G-7	Ukrainian	G-15
Greek 220	G-8	US Dvorak	G-15
Greek 319	G-8	US Dvorak Left	G-16
Greek Latin	G-7	US Dvorak Right	G-16
Greek Polytonic	G-8	US English	G-2
Hebrew Israel	G-8	US International	G-16
Hungarian	G-8	Uzbek	G-16
Hungarian_101KEY	G-8	Vietnamese	G-16
Irish	G-9	keyboard wedge	
Islandic	G-8	bar codes	9-4
Italian	G-9	connection	9-2
Italian (142)	G-9	default parameters	9-3
Japanese (ASCII)	G-9	keyboard map	9-10
Japanese (SHIFT-JIS)	G-9	Korean 2 of 5 bar codes	
Kazakh	G-9	sample	L-7
Korean (ASCII)	G-9	Korean 3 of 5 bar codes	12-74
Korean (Hangul)	G-10		
Kyrgyz	G-10	L	
Latin American	G-10	LED definitions	3-2
Latvian	G-10	LED indicators	
Latvian (QWERTY)	G-10	ADF programming	3-2
Lithuanian	G-10	host specific	3-3
Lithuanian (IBM)	G-10	parameter programming	3-2
Macedonian (FYROM)	G-11	scanning	3-2
Maltese_47KEY	G-11	standard	3-2
Mongolian	G-11		
Norwegian	G-11	M	
Polish (214)	G-11	macro PDF	12-109
Polish (Programmer)	G-11	abort entry	12-109
Portuguese (Brazil)	G-11	flush buffer	12-109
Portuguese (Brazilian ABNT)	G-12	maintenance	4-1
Portuguese (Brazilian ABNT2)	G-12	approved cleaners for standard devices	4-2
Portuguese (Portugal)	G-12	approved disinfectant cleaners for healthcare devices	4-2
Romanian	G-12	how to clean the devices	4-3
Romanian (Legacy)	G-12	known harmful ingredients	4-2
Romanian (Programmer)	G-13	matrix 2 of 5 bar codes	12-71
Romanian (Standard)	G-12	check digit	12-73
Russian	G-13	lengths	12-71
Russian (Typewriter)	G-13	sample	L-7
Serbian (Cyrillic)	G-13	transmit check digit	12-73
Serbian (Latin)	G-13	maxicode bar codes	12-95
Slovak	G-13	sample	L-11
Slovak (QWERTY)	G-14		
Slovenian	G-14		
Spanish	G-14		

MDF	16-1
microPDF417 bar codes	12-90
microQR code bar codes	
sample	L-12
mounting the stand	3-5
MSI bar codes	12-65
check digit algorithm	12-69
check digits	12-67
lengths	12-65
reduced quiet zone	12-69
sample	L-6
transmit check digit	12-67
multicode data formatting	16-1

N

night mode	10-14
non-parameter attributes	K-1, M-1
beep on next bootup	K-4
configuration filename	K-2
date of first programming	K-2
date of manufacture	K-2
firmware version	K-5
host trigger session	K-4
model number	K-1
parameter defaults	K-4
reboot	K-4
scankit version	K-5
scanspeed analytics	K-5
serial number	K-1

O

OCR	
bar codes	13-3
default parameters	13-2

P

page	
motor	10-12
parameter programming indicators	3-2
parts	3-1
PDF417 bar codes	12-90
PDF prioritization	10-31
sample	L-10
pinouts	
scanner signal descriptions	4-12
postal code bar codes	12-110
Australia post	12-113
Australia post format	12-114
Japan postal	12-112
mailmark	12-116
Netherlands KIX code	12-115

sample	L-14
transmit UK postal check digit	12-112
transmit US postal check digit	12-111
UK postal	12-111
UPU FICS postal	12-116
US planet	12-110
US postnet	12-110
USPS 4CB/One Code/Intelligent Mail	12-115
power supply	1-2
connecting	1-4
preferred symbol	16-4
presentation mode	3-4, 3-6
field of view	10-32
product line configurations	xxii

Q

QR code bar codes	12-96
GS1 QR	12-96
microQR	12-97
sample	L-12, L-13, L-14, L-15
quick start guide	1-2

R

related documents	xxiv
related software	xxiv
RS-232	
bar codes	7-7
connection	7-2
default parameters	7-3
host parameters	7-4
RSM	
commands and responses over SSI	6-8

S

sample bar codes	
aztec	L-13
Chinese 2 of 5	L-7
code 11	L-6
code 128	L-4
code 39	L-1, L-5
code 93	L-5
data matrix	L-11, L-12, L-13, L-14, L-15
grid matrix	L-13
gs1 data matrix	L-11
GS1 databar	L-8
GS1 QR	L-12
han xin	L-13
interleaved 2 of 5	L-6
Korean 2 of 5	L-7
matrix 2 of 5	L-7
maxicode	L-11

- microQR code L-12
 - MSI L-6
 - PDF417 L-10
 - QR code L-12, L-13, L-14, L-15
 - UK postal L-14
 - UPC/EAN L-1
 - US postnet L-14
 - scan speed analytics M-1
 - scanner control app 2-4
 - scanning
 - aiming 3-7
 - hand-held mode 3-4, 3-7
 - hands-free mode 3-4, 3-6
 - presentation mode 3-4
 - scanning indicators 3-2
 - security
 - 1D quiet zone level 12-84
 - intercharacter gap size 12-85
 - redundancy level 12-81
 - security level 12-83
 - service information xxv
 - setting defaults 10-5
 - setup
 - connecting a keyboard wedge host 9-2
 - connecting a USB interface 5-2
 - connecting an IBM most 8-2
 - connecting an RS-232 interface 7-2
 - connecting power 1-4
 - installing interface cable 1-3
 - unpacking 1-2
 - signal descriptions 4-12
 - signature capture 11-19
 - bits per pixel 11-21
 - code definition J-1
 - code structure J-1
 - data format J-3
 - dimensions J-3
 - file format selector 11-20
 - height 11-22
 - JPEG quality 11-22
 - signature boxes J-4
 - start and stop patterns J-2
 - width 11-22
 - software tools
 - 123Scan 2-1
 - ADF 16-1
 - MDF 16-1
 - preferred symbol 16-4
 - scanner control app 2-4
 - specifications 4-9
 - SSI
 - bar codes 6-12
 - commands 6-2
 - communications 6-1, 6-5
 - data transmission 6-4
 - default parameters 6-11
 - event reporting 6-22
 - handshaking 6-3, 6-5
 - low power mode 6-7
 - RSM commands and responses 6-8
 - RTS CTS 6-5
 - transactions 6-3
 - stand
 - assembling 3-4
 - mounting 3-5
 - support xxv
 - symbolologies
 - bar codes 12-9
 - default parameters 12-2
- ## T
- technical specifications 4-9
 - trigger mode, hand-held 10-21
 - troubleshooting 4-5
- ## U
- unicode
 - output control I-2
 - unpacking 1-2
 - UPC/EAN/JAN bar codes
 - bookland EAN 12-12
 - bookland ISBN 12-13
 - convert UPC-E to UPC-A 12-25
 - convert UPC-E1 to UPC-A 12-25
 - coupon report 12-27
 - decode supplementals 12-15
 - EAN/JAN zero extend 12-26
 - EAN-13/JAN-13 12-12
 - EAN-8/JAN-8 12-11
 - ISSN EAN 12-14
 - samples L-1
 - supplemental AIM ID format 12-19
 - supplemental redundancy 12-18
 - transmit UPC-A check digit 12-20
 - transmit UPC-E check digit 12-20
 - transmit UPC-E1 check digit 12-21
 - UCC coupon extended code 12-26
 - UPC reduced quiet zone 12-28
 - UPC-A 12-10
 - UPC-A preamble 12-22
 - UPC-E 12-10
 - UPC-E preamble 12-23
 - UPC-E1 12-11
 - UPC-E1 preamble 12-24
 - user programmable supplementals 12-18
- ## USB

bar codes 5-6
connection 5-2
default parameters 5-4

V

version
 bar codes 4-8
video
 image size 11-23
 view finder 11-23



Zebra Technologies Corporation
Lincolnshire, IL U.S.A.
www.zebra.com

ZEBRA and the stylized Zebra head are trademarks of Zebra Technologies Corporation, registered in many jurisdictions worldwide. All other trademarks are the property of their respective owners. ©2022 Zebra Technologies Corporation and/or its affiliates. All rights reserved.