

TC70x/TC75x

Touch Computer

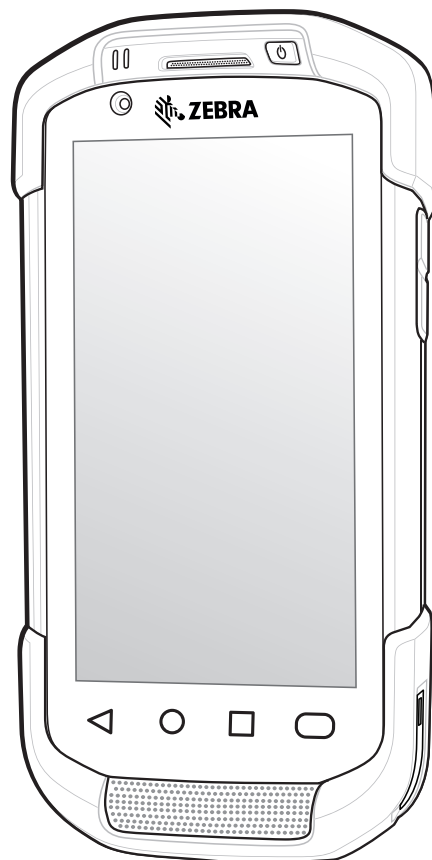

User Guide for Android™ 8.1 Oreo



ZEBRA

ZEBRA and the stylized Zebra head are trademarks of Zebra Technologies Corporation, registered in many jurisdictions worldwide. Google, Android, Google Play and other marks are trademarks of Google LLC. All other trademarks are the property of their respective owners. ©2024 Zebra Technologies Corporation and/or its affiliates. All rights reserved.

Information in this document is subject to change without notice. The software described in this document is furnished under a license agreement or nondisclosure agreement. The software may be used or copied only in accordance with the terms of those agreements.

For further information regarding legal and proprietary statements, please go to:

SOFTWARE: zebra.com/linkoslegal.

COPYRIGHTS: zebra.com/copyright.

PATENTS: ip.zebra.com.

WARRANTY: zebra.com/warranty.

END USER LICENSE AGREEMENT: zebra.com/eula.

Terms of Use

Proprietary Statement

This manual contains proprietary information of Zebra Technologies Corporation and its subsidiaries (“Zebra Technologies”). It is intended solely for the information and use of parties operating and maintaining the equipment described herein. Such proprietary information may not be used, reproduced, or disclosed to any other parties for any other purpose without the express, written permission of Zebra Technologies.

Product Improvements

Continuous improvement of products is a policy of Zebra Technologies. All specifications and designs are subject to change without notice.

Liability Disclaimer

Zebra Technologies takes steps to ensure that its published Engineering specifications and manuals are correct; however, errors do occur. Zebra Technologies reserves the right to correct any such errors and disclaims liability resulting therefrom.

Limitation of Liability

In no event shall Zebra Technologies or anyone else involved in the creation, production, or delivery of the accompanying product (including hardware and software) be liable for any damages whatsoever (including, without limitation, consequential damages including loss of business profits, business interruption, or loss of business information) arising out of the use of, the results of use of, or inability to use such product, even if Zebra Technologies has been advised of the possibility of such damages. Some jurisdictions do not allow the exclusion or limitation of incidental or consequential damages, so the above limitation or exclusion may not apply to you.

Revision History

Changes to the original guide are listed below:

Change	Date	Description
-01EN Rev A	08/2018	Initial release.
-02EN Rev A	10/2018	Add WWAN information.
-03EN Rev A	07/2019	Add note warning against user modification of the device, particularly in the battery well.
-04EN Rev A	05/2024	Added new topic - Rigid Holster

Contents

About This Guide	14
Documentation Set	14
Configurations	14
Software Versions	15
Chapter Descriptions	15
Notational Conventions	16
Related Documents	16
Service Information	16
Feedback	17
Getting Started	18
Unpacking the Device	18
Features	19
Setting Up the Device	21
Installing the SIM Card	22
Installing a microSD Card	23
Installing the Hand Strap and Battery	24
Installing a Battery	26
Charging the Battery	26
Charging Indicators	27
Google Account Setup	27
Zebra Visibility Services	27
Replacing the Battery	28
Replacing the SIM Card	30
Replacing the microSD Card	32
Accessing Device Settings	33
Battery Management	33
Monitoring Battery Usage	34
Low Battery Notification	34
Battery Optimization	35
Turning Off the Radios	35

Setting the Date and Time	35
Display Settings	36
Setting the Screen Brightness	36
Setting Screen Timeout	36
Ambient Display	37
Setting Touch Key Light	37
Setting Font Size	39
Setting Screen Rotation	39
Touch Panel Mode	40
Setting Display Size	40
General Sound Setting	41
Wake-Up Sources	42
Using the Device	44
Google Mobile Services	44
Home Screen	44
Setting Home Screen Rotation	45
Status Bar	46
Status Icons	46
Notification Icons	48
Managing Notifications	49
Setting App Notifications	49
Viewing Notification Settings for All Apps	50
Controlling Lock Screen Notifications	50
Blink Light	50
Quick Access Panel	51
Editing Icons on Quick Settings	52
App Shortcuts and Widgets	52
Adding an App Shortcut to the Home Screen	53
Adding a Widget to the Home Screen	53
Moving Items on the Home Screen	53
Removing an App Shortcut or Widget from the Home Screen	53
Folders	53
Creating a Folder	53
Naming Folders	54
Removing a Folder	54
Home Screen Wallpaper	54
Using the Touchscreen	54
Keyboards	55
Keyboard Configuration	55
Enabling Keyboards	55
Switching Between Keyboards	55
Using the Android and Gboard Keyboards	56

Editing Text	56
Entering Numbers, Symbols, and Special Characters	56
Using the Enterprise Keyboard	56
Numeric Tab	56
Alpha Tab	57
Additional Character Tab	57
Scan Tab	58
Do Not Disturb Feature	58
Limit Sounds and Vibrations	58
Total Silence	58
Alarms Only	59
Priority Notifications Only	59
Automatically Block Sounds and Vibrations	60
Silence Sounds During Certain Times	60
Silence Sounds During Events and Meetings	60
Turn Sounds Back On	60
Override Do Not Disturb for Specific Apps	61
Apps	61
Accessing Apps	64
Switching Between Recent Apps	65
Un-Locking the Screen	66
Interactive Sensor Technology	67
Resetting the Device	68
Performing a Soft Reset	68
Performing a Hard Reset	68
Suspend Mode	68
Transferring Files with a Host Computer via USB	68
Transferring Files	69
Transferring Photos	69
Disconnect from the Host Computer	69
Applications.....	71
Battery Manager	71
Camera	74
Taking Photos	74
Taking a Panoramic Photo	75
Recording Videos	75
Photo Settings	76
Rear Camera	77
Front Camera	77
Video Settings	77
Rear Camera	78

Contents

Front Camera	78
Contacts	79
Adding a Contact	79
Editing Contacts	79
Deleting Contacts	79
DataWedge Demonstration	79
Scanner Selection	81
Device Central	81
Device Central Tabs	82
Paging an RS6000 Ring Scanner	82
Diagnostic Tool	83
Settings	86
Battery Test Information	86
GPS Test Information	86
System Test Information	86
WLAN Test Information	87
WWAN Test Information	87
Bluetooth Test Information	87
Files	88
Gallery	89
Working with Albums	91
Sharing an Album	91
Getting Album Information	91
Deleting an Album	92
Working with Photos	92
Viewing and Browsing Photos	92
Cropping a Photo	93
Setting a Photo as a Contact Icon	93
Sharing a Photo	94
Deleting a Photo	94
Working with Videos	94
Watching Videos	94
Sharing a Video	94
Deleting a Video	95
Messaging	95
Sending a Text Message	95
Sending a Multimedia Message	96
Photos	97
Working with Photos	98
Viewing and Browsing Photos	98
Cropping a Photo	99
Setting a Photo as a Contact Icon	100
Sharing a Photo	100
Deleting a Photo	101

Working with Albums	101
Sharing an Album	101
Deleting an Album	102
Working with Videos	102
Watching a Video	102
Sharing a Video	102
Deleting a Video	102
PTT Express Voice Client	103
PTT Express User Interface	103
PTT Audible Indicators	103
PTT Notification Icons	104
Enabling PTT Communication	104
Selecting a Talk Group	105
PTT Communication	105
Creating a Group Call	105
Responding with a Private Response	105
Disabling PTT Communication	106
RxLogger	106
RxLogger Utility	107
SimulScan Demo	107
Printing the Sample Forms	108
Using the Postal, Transportation and Logistics Example	109
Using the Manufacturing Example	111
Settings	112
Advanced Settings	113
Creating a Demo Customization	113
Default Templates	115
Sound Recorder	115
Data Capture.....	116
Imaging	116
Operational Modes	116
RS507/RS507X Hands-Free Imager	117
RS6000 Bluetooth Ring Scanner	117
DS3678 Digital Scanner	118
Scanning Considerations	118
Scanning with Internal Imager	118
Scanning with RS507/RS507X Hands-Free Imager	120
Scanning with RS6000 Bluetooth Ring Scanner	121
Scanning with the DS3608 USB Scanner or DS3678 Bluetooth Scanner	123
Pairing the RS507/RS507X/RS6000 Hands-Free Imager	124
Pairing Using Near Field Communication	124

Pairing in HID Mode Using Near Field Communication	124
Pairing Using Simple Serial Interface (SSI)	125
Pairing Using Bluetooth Human Interface Device	126
Pairing a Bluetooth Scanner	127
Pairing Using Bluetooth Human Interface Device	127
DataWedge	128
Enabling DataWedge	128
Disabling DataWedge	128
Calls	129
Emergency Calling	129
Audio Modes	129
Using a Bluetooth Headset	129
Using a Wired Headset	129
Adjusting Audio Volume	130
Making a Call Using the Dialer	130
Dialer Dialing Options	132
Making a Call Using Contacts	132
Using the Dialer	132
Using the Contacts App	133
Making a Call Using Call History	134
Making a Conference Call	134
Making a Call Using a Bluetooth Headset	136
Answering Calls	137
Call Settings	138
Wireless	140
Wireless Wide Area Networks	140
Sharing the Mobile Data Connection	140
Enabling USB Tethering	140
Enabling Bluetooth Tethering	141
Enabling Wi-Fi Hotspot	141
Configuring the Wi-Fi Hotspot	141
Cellular Network Settings	142
Disabling Data When Roaming	142
CDMA Devices	142
Preferred Network Type	143
Enhanced 4G LTE Mode	143
Using Search for MicroCell	143
Using System Select	143
Locking the SIM Card	144

Data Usage	144
Setting Data Usage Warning	144
Setting Data Limit	145
Wireless Local Area Networks	145
Connecting to a Wi-Fi Network	145
Removing a Wi-Fi Network	147
Bluetooth	147
Adaptive Frequency Hopping	147
Security	148
Bluetooth Profiles	148
Bluetooth Power States	149
Bluetooth Radio Power	149
Enabling Bluetooth	149
Disabling Bluetooth	149
Discovering Bluetooth Device(s)	150
Changing the Bluetooth Name	150
Connecting to a Bluetooth Device	150
Selecting Profiles on the Bluetooth Device	150
Unpairing a Bluetooth Device	151
Near Field Communications	151
Reading NFC Cards	151
Sharing Information Using NFC	152
Cast	153
Accessories.....	154
2-Slot Charge Only Cradle	156
Charging the Device	157
Charging the Spare Battery	158
Battery Charging	158
Main Battery Charging	158
Spare Battery Charging	158
Charging Temperature	159
2-Slot USB/Ethernet Cradle	159
Charging the Device	160
Charging the Spare Battery	161
Battery Charging	161
Main Battery Charging	161
Spare Battery Charging	161
Charging Temperature	162
USB/Ethernet Communication	162
Ethernet LED Indicators	163
Establishing Ethernet Connection	163

5-Slot Charge Only Cradle	163
Charging the TC75	164
Battery Charging	165
Main Battery Charging	165
Spare Battery Charging	165
Charging Temperature	165
4-Slot Charge Only Cradle with Battery Charger	165
Charging the Device	167
Battery Charging	167
Main Battery Charging	167
Spare Battery Charging	167
Charging Temperature	168
5-Slot Ethernet Cradle	168
Charging the Device	170
Battery Charging	171
Main Battery Charging	171
Spare Battery Charging	171
Charging Temperature	171
Establishing Ethernet Connection	171
LED Indicators	172
4-Slot Battery Charger	172
Charging Spare Batteries	172
Battery Charging	173
Spare Battery Charging	173
Charging Temperature	173
3.5 mm Audio Adapter	173
Connecting a Headset to the 3.5 mm Audio Adapter	174
Attaching the 3.5 mm Audio Adapter	175
Device with 3.5 mm Audio Adapter in Holster	175
Removing the 3.5 mm Audio Adapter	176
Rigid Holster	176
Installing the TC7X into the Rigid Holster	176
Removing the TC7X from the Rigid Holster	177
Snap-On USB Cable	178
Connecting to Device	178
USB Communication	179
Charging the Device	179
Disconnecting from Device	180
Battery Charging	180
Main Battery Charging	180
Charging Temperature	180
Charging Cable Cup	180
Charging the Device	181

Contents

Battery Charging	182
Main Battery Charging	182
Charging Temperature	182
Snap-On DEX Cable	182
Connecting to Device	183
DEX Communication	183
Disconnecting from Device	184
Trigger Handle	185
Installing the Attachment Plate to Trigger Handle	185
Installing the Trigger Handle Plate	185
Inserting the Device into the Trigger Handle	187
Removing the Device from the Trigger Handle	189
Vehicle Charging Cable Cup	191
Charging the Device	192
Battery Charging	193
Main Battery Charging	193
Charging Temperature	193
Vehicle Cradle	193
Device Insertion and Removal	195
Battery Charging	196
TC7X Vehicle Communication Charging Cradle	196
Device Insertion and Removal	198
Device Battery Charging	198
Charging Note	198
USB I/O Hub	199
Connect USB Cables	199
External USB Cable	200
Power to Vehicle Cradle	201
Audio Headset Connection	201
Maintenance and Troubleshooting.....	203
Maintaining the Device	203
Battery Safety Guidelines	203
Cleaning Instructions	204
Approved Cleanser Active Ingredients	204
Harmful Ingredients	204
Device Cleaning Instructions	205
Special Cleaning Notes	205
Cleaning Materials Required	205
Cleaning Frequency	205
Cleaning the Device	205

Contents

Housing	205
Display	206
Camera and Exit Window	206
Cleaning Battery Connectors	206
Cleaning Cradle Connectors	206
Troubleshooting	207
Technical Specifications	210

About This Guide

This guide provides information about setting up and using TC70x/TC75x touch computers with the Android 8.1 operating system. Some screens shown in this guide may differ from the actual screens shown on the device.



NOTE: Screens and windows pictured in this guide are samples and can differ from actual screens.

Documentation Set

The documentation set for the device provides information for specific user needs, and includes:

- TC70x/TC75x Touch Computer Quick Start Guide for Android Version 6.0.1 - Describes how to get the device up and running.
- TC70x/TC75x Touch Computer User Guide for Android Version 8.1 - Describes how to use the device.
- TC70x/TC75x Touch Computer Integrator Guide for Android Version 8.1 - Describes how to set up the device and accessories.

Configurations

This guide covers the following configurations:

Configuration	Radios	Display	Memory	Data Capture Options	Operating System
TC700K	WLAN: 802.11 a/b/g/n/d/h/i/r WPAN: Bluetooth v4.0 Low Energy	4.7" High Definition (1280 x 720) LCD	4 GB RAM/32 GB Flash	2D imager, camera, or integrated NFC	Android 8.1
TC75EK	WWAN: HSPA+/LTE/C DMA WLAN: 802.11 a/b/g/n/d/h/i/r WPAN: Bluetooth v4.0 Low Energy	4.7" High Definition (1280 x 720) LCD	4 GB RAM/32 GB Flash	2D imager, camera and integrated NFC	Android 8.1

Configuration	Radios	Display	Memory	Data Capture Options	Operating System
TC75FK	WWAN: HSPA+/LTE WLAN: 802.11 a/b/g/n/d/h/i/r WPAN: Bluetooth v4.0 Low Energy	4.7" High Definition (1280 x 720) LCD	4 GB RAM/32 GB Flash	2D imager, camera and integrated NFC	Android 8.1
TC75GK	WWAN: HSPA+/LTE WLAN: 802.11 a/b/g/n/d/h/i/r WPAN: Bluetooth v4.0 Low Energy	4.7" High Definition (1280 x 720) LCD	4 GB RAM/32 GB Flash	2D imager, camera and integrated NFC	Android 8.1

Software Versions

To determine the current software versions:

1. Swipe down from the Status bar to open the Quick Settings bar.
2. Touch **⚙️ > System**.
3. Touch **About phone**.
4. Scroll to view the following information:
 - **Model**
 - **Android version**
 - **Kernel version**
 - **Build number**.

To determine the device serial number, touch **About phone > Status**.

- **Serial number**

Chapter Descriptions

Topics covered in this guide are as follows:

- Getting Started provides information on getting the device up and running for the first time.
- Using the Device provides information for operating the device.
- Calls provides instructions for making phone calls.
- Applications provides information on using applications installed on the device.
- Data Capture provides information for capturing barcode data using the imager.
- Wireless provides information on the various wireless options.
- Accessories provides information for using the accessories for the device.
- Maintenance and Troubleshooting includes instructions on cleaning and provides troubleshooting solutions for potential problems during device operation.

- Technical Specifications provides the technical specifications for the device.

Notational Conventions

The following conventions are used in this document:

- **Bold** text is used to highlight the following:
 - Dialog box, window and screen names
 - Drop-down list and list box names
 - Check box and radio button names
 - Icons on a screen
 - Key names on a keypad
 - Button names on a screen.
- Bullets (•) indicate:
 - Action items
 - Lists of alternatives
 - Lists of required steps that are not necessarily sequential.
- Sequential lists (for example, those that describe step-by-step procedures) appear as numbered lists.

Related Documents

- TC70x/TC75x Touch Computer Quick Start Guide for Android Version 6.0.1, p/n MN-002879-xx.
- TC75x Touch Computer Regulatory Guide for Android Version 6.0.1, p/n MN-002880-xx.
- TC70x Touch Computer Regulatory Guide for Android Version 6.0.1, p/n MN-002960-xx.
- TC70x/TC75x Touch Computer Integrator Guide for Android Version 8.1, p/n MN-003375-xx.
- RS507 Hands-free Imager Product Reference Guide, p/n 72E-12082-xx.
- DS36X8 Product Reference Guide, p/n MN-002689-xx.
- RS6000 User Guide, MN-002704-xx.

For the latest version of this guide and all guides, go to: zebra.com/support.

Service Information

If you have a problem with your equipment, contact Customer Support for your region. Contact information is available at: zebra.com/support.

When contacting support, please have the following information available:

- Serial number of the unit (found on manufacturing label)
- Model number or product name (found on manufacturing label)
- Software type and version number
- IMEI number.

Customer Support responds to calls by email or telephone within the time limits set forth in support agreements.

If the problem cannot be solved by Customer Support, you may need to return the equipment for servicing and will be given specific directions. We are not responsible for any damages incurred during shipment if the

About This Guide

approved shipping container is not used. Shipping the units improperly can possibly void the warranty. Remove the SIM card and/or microSD card from the device before shipping for service.

If the device was purchased from a business partner, contact that business partner for support.

Feedback

If you have comments, questions, or suggestions about this guide, send an email to EVM-Techdocs@zebra.com.

Getting Started

This section provides information for getting the device up and running for the first time.

Unpacking the Device

1. Carefully remove all protective material from the device and save the shipping container for later storage and shipping.
2. Verify that the following were received:
 - Touch computer
 - 4620 mAh PowerPrecision+ Lithium-ion battery
 - Hand strap
 - Regulatory Guide.
3. Inspect the equipment for damage. If any equipment is missing or damaged, contact the Global Customer Support center immediately.
4. Prior to using the device for the first time, remove the protective shipping film that covers the scan window, display and camera window.

Features

Figure 1 Front View

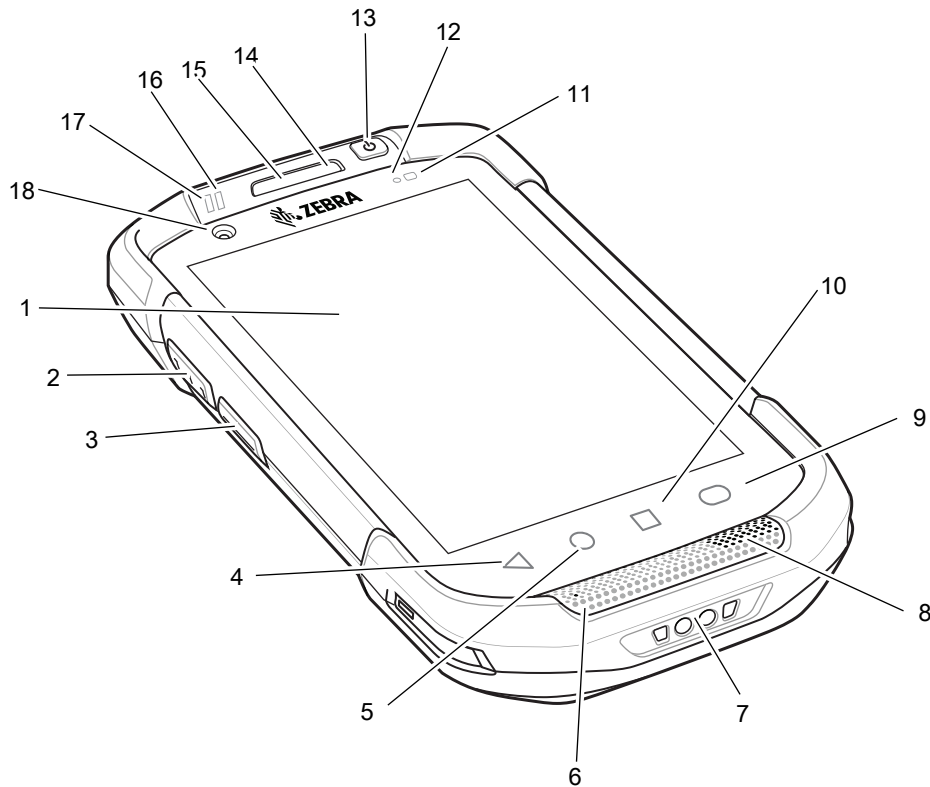

Table 1 Front View Features

Number	Item	Function
1	Touch Screen	Displays all information needed to operate the device.
2	Scan Button	Initiates data capture (programmable).
3	PTT Button	Initiates push-to-talk communications (programmable).
4	Back Button	Displays the previous screen.
5	Home Button	Displays the Home screen with a single press. On device with GMS, opens the Google Now screen when held for a short period of time.
6	Microphone	Use for communications in Handset mode.
7	Charging Contacts	Provides power to the device from cables and cradles.
8	Speaker	Provides audio output for video and music playback. Provides audio in speakerphone mode.
9	Search Button	Opens the Recent App screen.
10	Menu Button	Opens a menu with items that affect the current screen or application.
11	Light Sensor	Determines ambient light for controlling display backlight intensity.
12	Proximity Sensor	Determines proximity for turning off display when in handset mode.

Table 1 *Front View Features (Continued)*

Number	Item	Function
13	Power Button	Turns the display on and off. Press and hold to reset the device, power off or swap battery.
14	Microphone	Use for communications in Speakerphone mode.
15	Receiver	Use for audio playback in Handset mode.
16	Charging/Notification LED	Indicates battery charging status while charging and application generated notifications.
17	Data Capture LED	Indicates data capture status.
18	Front Facing Camera	Use to take photos and videos (optional).

Figure 2 Rear View

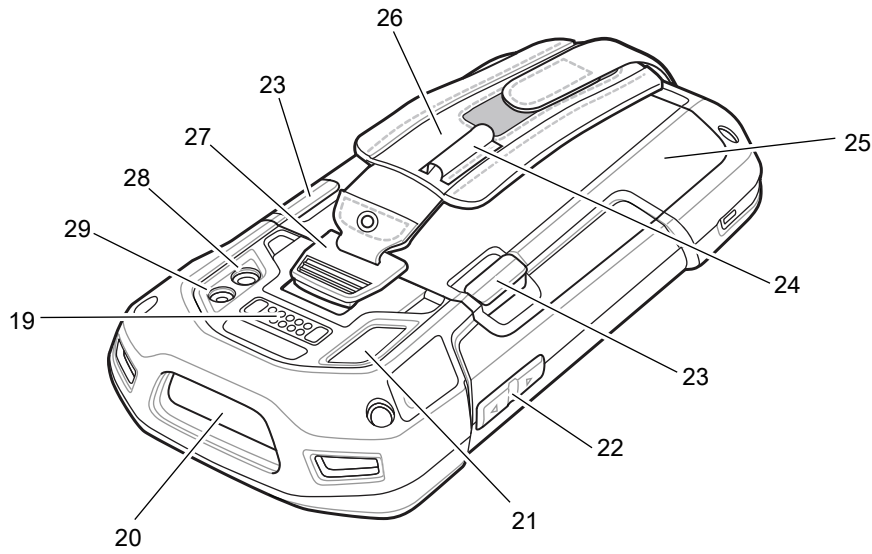

Table 2 Back View Features

Number	Item	Function
19	Interface Connector	Provides USB host and client communications, audio and device charging via cables and accessories.
20	Exit Window	Provides data capture using the imager.
21	Microphone	Use during video recording and for noise cancellation.
22	Volume Up/Down Button	Increase and decrease audio volume (programmable).
23	Battery Release Latches	Press to remove the battery.
24	Elastic Sleeve	Use to hold optional stylus.
25	Battery	Provides power to the device.
26	Hand strap	Use to securely hold the device in your hand.
27	Hand strap Mounting Point	Provides latching point for the hand strap.
28	Camera	Takes photos and videos.
29	Camera Flash	Provides illumination for the camera.

Setting Up the Device

Perform this procedure to start using the device for the first time.

1. Install a SIM card (TC75x only).
2. Install a micro secure digital (SD) card (optional).
3. Install hand strap (optional).
4. Install the battery.

5. Charge the device.
6. Power on the device.

Installing the SIM Card



NOTE: TC75x only.

NOTE: The TC75x may contain one mini SIM slot and two nano SIM slots. If using a micro SIM card, a third-party SIM adapter is required. By default, use a nano SIM card in slot 1.



CAUTION: Follow proper electrostatic discharge (ESD) precautions to avoid damaging the SIM card. Proper ESD precautions include, but not limited to, working on an ESD mat and ensuring that the user is properly grounded.

1. Remove access cover.

Figure 3 TC75x SIM Slot Locations

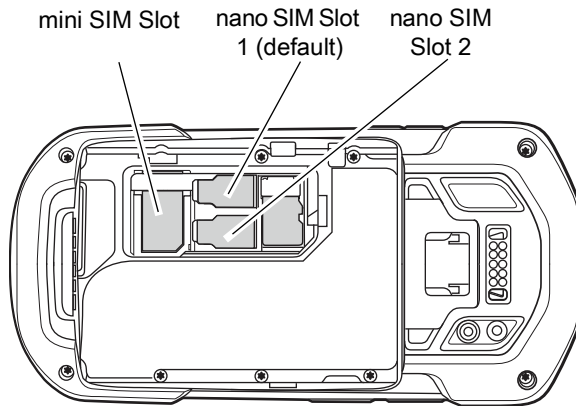

2. Insert a SIM card into the SIM slot with the cut edge toward the middle of the device and the contacts facing down.

Figure 4 nano SIM Card Installation

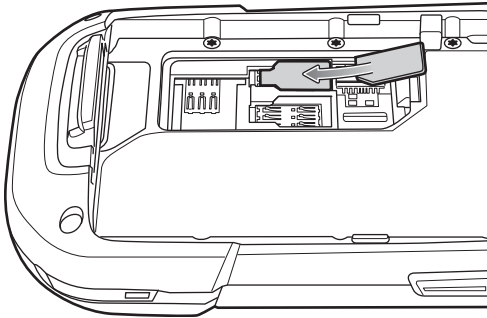
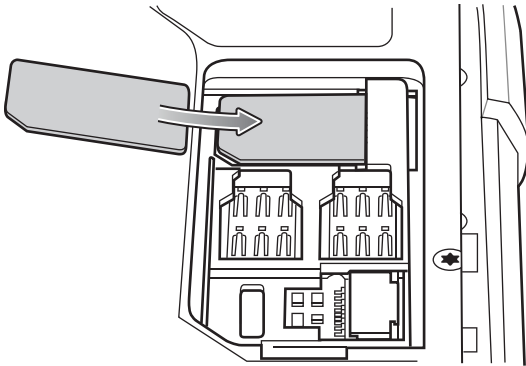

Figure 5 Mini SIM Card Installation



3. Ensure that the SIM card is seated properly.

Installing a microSD Card

The microSD card slot provides secondary non-volatile storage. The slot is located under the battery pack. Refer to the documentation provided with the card for more information, and follow the manufacturer's recommendations for use.



CAUTION: Follow proper electrostatic discharge (ESD) precautions to avoid damaging the microSD card. Proper ESD precautions include, but are not limited to, working on an ESD mat and ensuring that the operator is properly grounded.

1. Remove the hand strap, if installed.
2. Lift the access door.

Figure 6 Lift Access Door

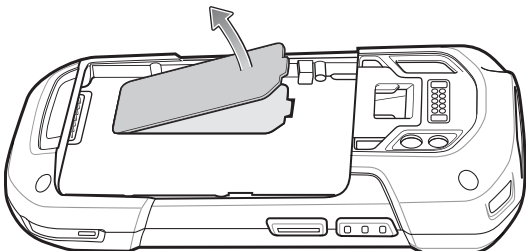

3. Insert the microSD card into the card holder door ensuring that the card slides into the holding tabs on each side of the door.

Figure 7 Insert microSD Card in Holder

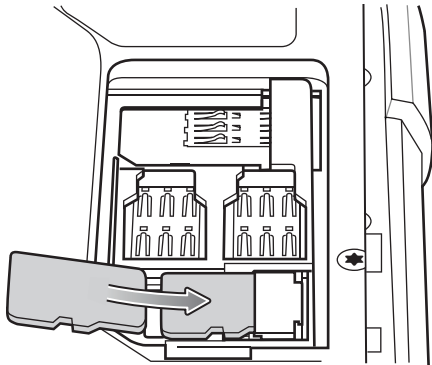

4. Re-install the access door.

Installing the Hand Strap and Battery



NOTE: User modification of the device, particularly in the battery well, such as labels, asset tags, engravings, stickers, etc., may compromise the intended performance of the device or accessories. Performance levels such as sealing (Ingress Protection (IP)), impact performance (drop and tumble), functionality, temperature resistance, etc. could be effected. DO NOT put any labels, asset tags, engravings, stickers, etc. in the battery well.



NOTE: Installation of the hand strap is optional. Skip this section if not installing the hand strap.

1. Remove the hand strap filler from the hand strap slot. Store the hand strap filler in a safe place for future replacement.

Figure 8 Remove Filler

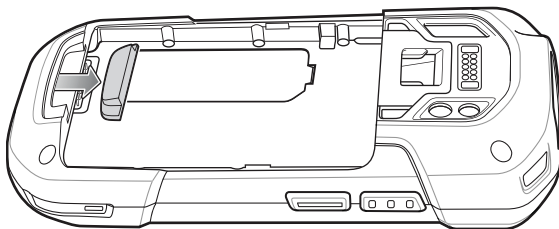

2. Insert the hand strap plate into the hand strap slot.

Figure 9 Insert Hand Strap

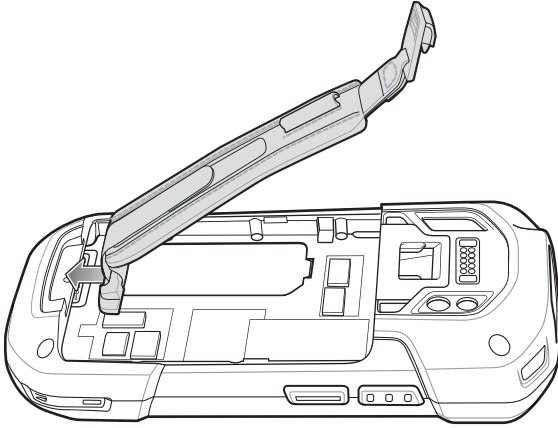

3. Insert the battery, bottom first, into the battery compartment in the back of the device.

Figure 10 Insert Bottom of Battery into Battery Compartment

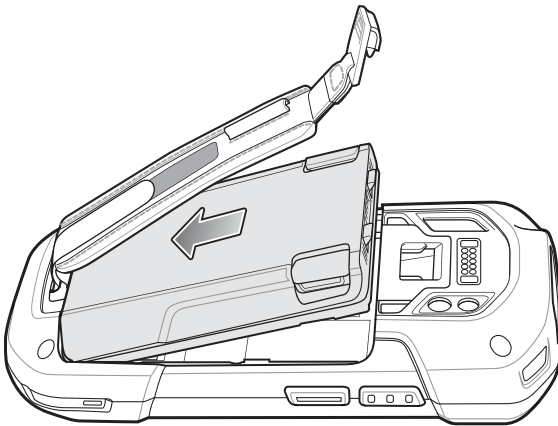

4. Press the battery down into the battery compartment until the battery release latches snap into place.

Figure 11 Press Down on Battery

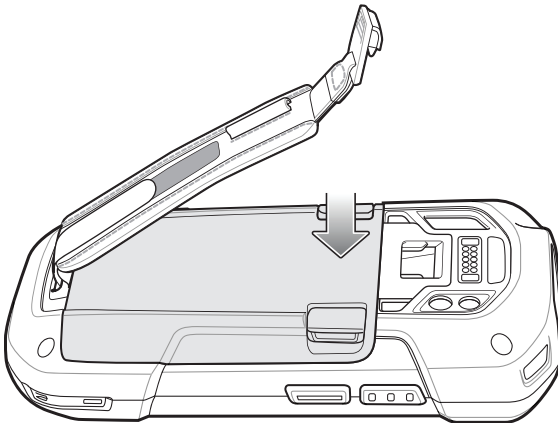

5. Place hand strap clip into hand strap mounting slot and pull down until it snaps into place.

Figure 12 Secure Hand Strap Clip

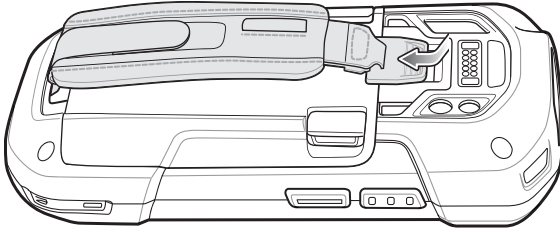

Installing a Battery



NOTE: User modification of the device, particularly in the battery well, such as labels, asset tags, engravings, stickers, etc., may compromise the intended performance of the device or accessories. Performance levels such as sealing (Ingress Protection (IP)), impact performance (drop and tumble), functionality, temperature resistance, etc. could be effected. DO NOT put any labels, asset tags, engravings, stickers, etc. in the battery well.

1. Insert the battery, bottom first, into the battery compartment in the back of the device.

Figure 13 Insert Bottom of Battery into Battery Compartment

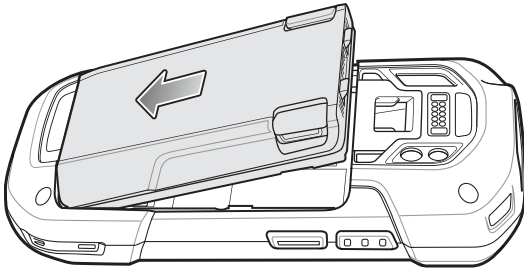

2. Press the battery down into the battery compartment until the battery release latches snap into place.

Figure 14 Press Down on Battery

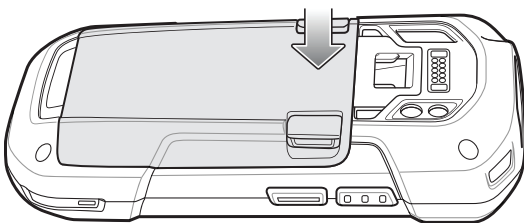

Charging the Battery

Before using the device for the first time, charge the main battery until the green Charging/Notification light emitting diode (LED) remains lit. To charge the device, use a cable or a cradle with the appropriate power supply. For information about the accessories available for the device, see [Accessories](#) for more information.

The 4620 mAh battery fully charges in less than five hours at room temperature.

Charge batteries in temperatures from 0°C to 40°C (32°F to 104°F). The device or accessory always performs battery charging in a safe and intelligent manner. At higher temperatures (approximately +37°C (+98°F)) the device or accessory may, for small periods of time, alternately enable and disable battery charging to keep the

battery at acceptable temperatures. The device or accessory indicates when charging is disabled due to abnormal temperatures via its LED.

To charge the main battery:

1. Connect the charging accessory to the appropriate power source.
2. Insert the device into a cradle or attach to a cable. The device turns on and begins charging. The Charging/Notification LED blinks amber while charging, then turns solid green when fully charged.

Charging Indicators

Table 3 *Charging/Notification LED Charging Indicators*

State	Indication
Off	The device is not charging. The device is not inserted correctly in the cradle or connected to a power source. Charger/cradle is not powered.
Slow Blinking Amber (1 blink every 4 seconds)	The device is charging.
Solid Green	Charging complete.
Fast Blinking Amber (2 blinks/second)	Charging error: <ul style="list-style-type: none"> • Temperature is too low or too high. • Charging has gone on too long without completion (typically eight hours).
Slow Blinking Red (1 blink every 4 seconds)	The device is charging but the battery is at end of useful life.
Solid Red	Charging complete but the battery is at end of useful life.
Fast Blinking Red (2 blinks/second)	Charging error but the battery is at end of useful life. <ul style="list-style-type: none"> • Temperature is too low or too high. • Charging has gone on too long without completion (typically eight hours).

Google Account Setup



NOTE: You must connect the device to the internet in order to set up a Google™ account. A Google account is only required on devices with GMS software.

The first time the device starts, the Setup Wizard displays. Follow the on-screen instructions to set up a Google account, configure Google Pay™ for purchasing items from the Google Play™ store, to enter your personal information, and enable backup or restore features.

Zebra Visibility Services

The device captures and provides device analytics to a system administrator. The first time the device boots (or after a Factory reset), the **Zebra Services** agreement screen displays.

Figure 15 Zebra Services

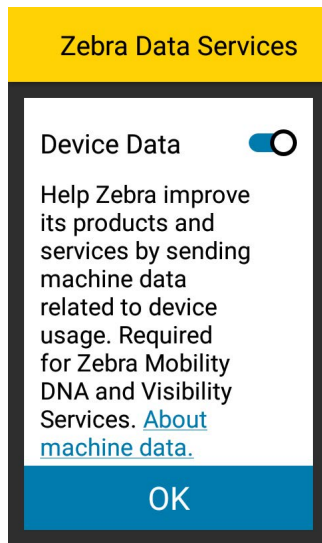

1. Touch the **Device Data** switch to disable the device from sending analytics data.
2. Touch OK.

Replacing the Battery



NOTE: User modification of the device, particularly in the battery well, such as labels, asset tags, engravings, stickers, etc., may compromise the intended performance of the device or accessories. Performance levels such as sealing (Ingress Protection (IP)), impact performance (drop and tumble), functionality, temperature resistance, etc. could be effected. DO NOT put any labels, asset tags, engravings, stickers, etc. in the battery well.



CAUTION: Do not add or remove SIM or microSD card during battery replacement.

1. Remove any accessory attached to the device.
2. Press the Power button until the menu appears.
3. Touch **Battery Swap**.
4. Follow the on-screen instructions.
5. Wait for the LED to turn off.
6. If hand strap is attached, slide the hand strap clip up toward the top of the device and then lift.

Figure 16 Remove Hand Strap Clip

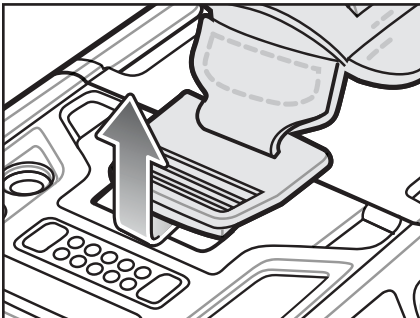

7. Press the two battery latches in.

Figure 17 Press Battery Latches

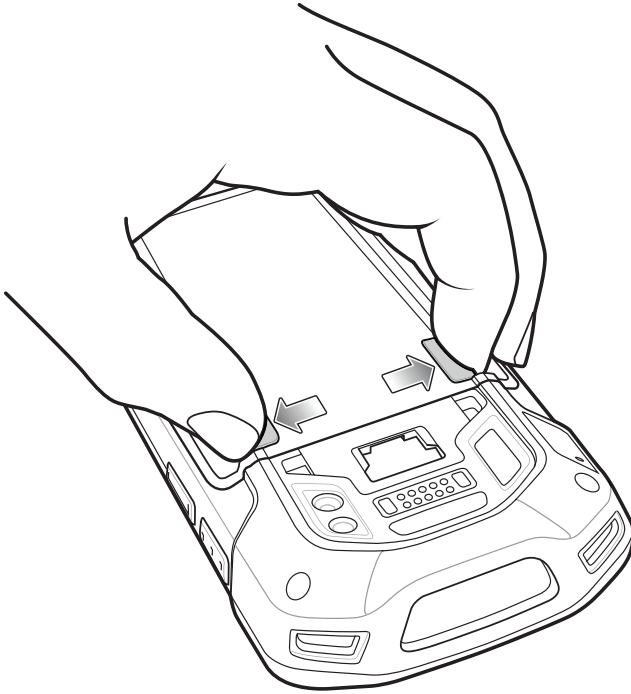

8. Lift the battery from the device.

Figure 18 Lift the Battery

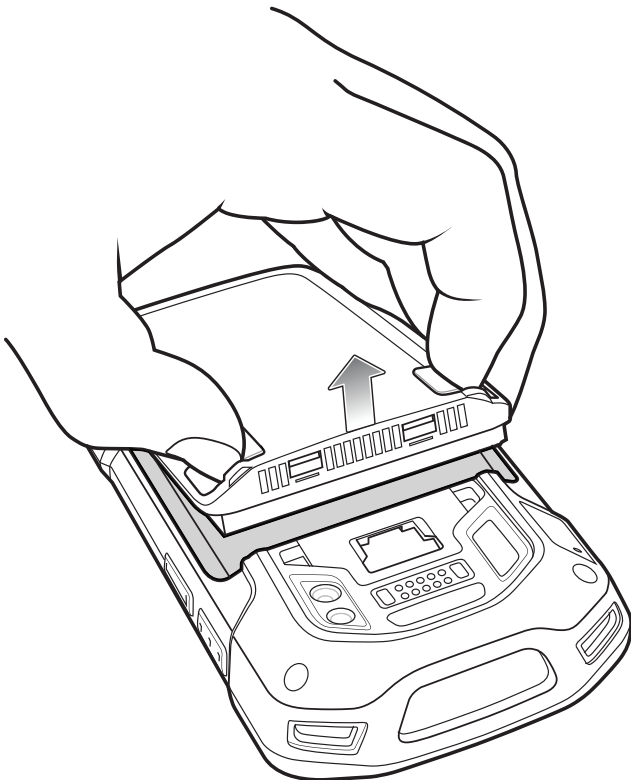

CAUTION: Replace the battery within two minutes. After two minutes the device reboots and data may be lost.

9. Insert the replacement battery, bottom first, into the battery compartment in the back of the device.
10. Press the battery down until the battery release latch snaps into place.
11. Replace the hand strap, if required.
12. Press and hold the Power button to turn on the device.



NOTE: After replacing the battery, wait 15 minutes before using **Battery Swap** again.

Replacing the SIM Card



NOTE: SIM replacement applies to TC75x only.

To replace the SIM card:

1. Press and hold the Power button until the menu appears.
2. Touch **Power off**.
3. Touch **OK**.
4. If hand strap is attached, slide the hand strap clip up toward the top of the device and then lift.

Figure 19 Remove Hand Strap Clip

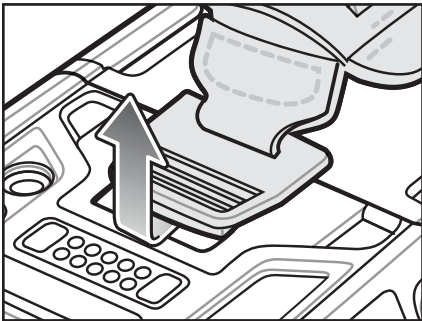

5. Press the two battery latches in.
6. Lift the battery from the device.
7. Lift the access door.

Figure 20 Remove Access Door

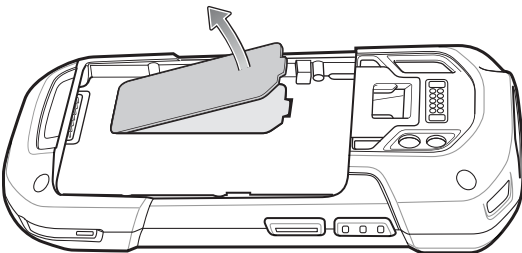

8. Remove card from holder.

Figure 21 Remove Mini SIM Card

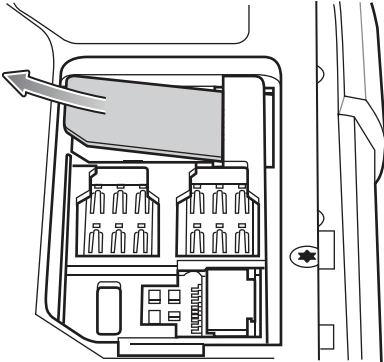
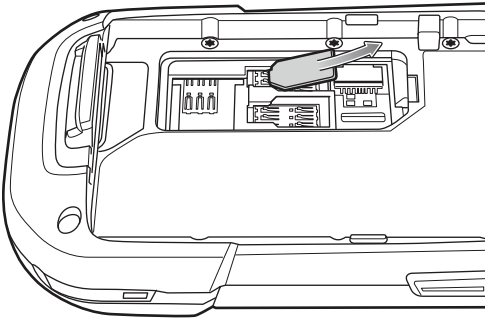

Figure 22 Remove Nano SIM Card



9. Insert the replacement card.

Figure 23 Insert Mini SIM Card

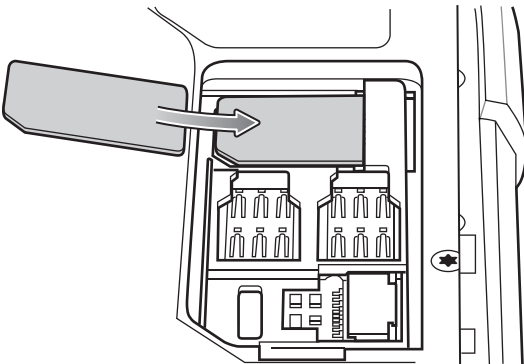
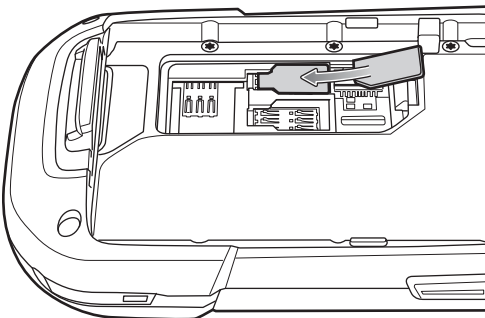
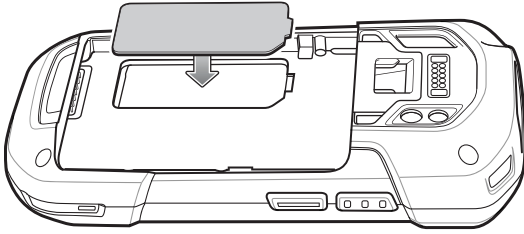

Figure 24 Insert Nano SIM Card



10. Replace the access door.

Figure 25 Replace Access Door



11. Press the access door down and ensure that it is properly seated.

12. Insert the battery, bottom first, into the battery compartment in the back of the device.

13. Press the battery down until the battery release latch snaps into place.

14. Replace the hand strap, if required.

15. Press and hold the Power button to turn on the device.

Replacing the microSD Card

To replace the microSD card:

1. Press the Power button until the menu appears.
2. Touch **Power off**.
3. Touch **OK**.
4. If hand strap is attached, slide the hand strap clip up toward the top of the device and then lift.

Figure 26 Remove Hand Strap Clip

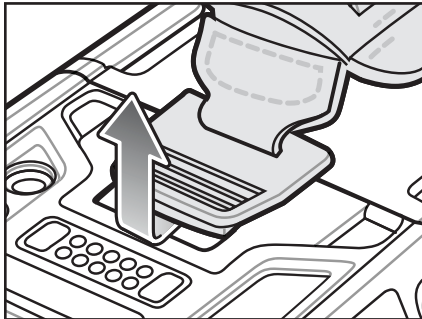

5. Press the two battery latches in.

6. Lift the battery from the device.

7. Lift the access door.

Figure 27 Remove Access Door

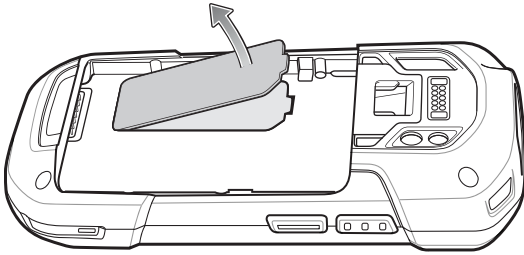

8. Remove microSD card from holder.
9. Press the access door down and ensure that it is properly seated.
10. Insert the replacement microSD card.
11. Replace the access door.

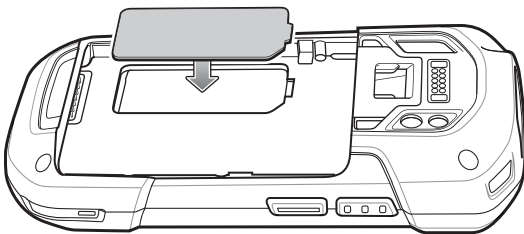

Figure 28 Replace Access Door



12. Insert the battery, bottom first, into the battery compartment in the back of the device.
13. Press the battery down until the battery release latch snaps into place.
14. Replace the hand strap, if required.
15. Press and hold the Power button to turn on the device.

Accessing Device Settings

To access device settings:

1. Swipe down from the Status bar to open the Quick Settings bar and then touch .
2. On the Home screen, swipe up from the bottom of the screen and touch .

Battery Management



NOTE: Prior to checking the battery charge level, remove the device from any AC power source (cradle or cable).

To check the charge status of the main battery, open **Settings** and touch **System > About phone > Battery Information**.

Battery present status indicates if the battery is present and **Battery level** lists the battery charge (as a percentage of fully charged). The battery percentage can also be viewed next to the battery icon in the quick access panel. Swipe down with two fingers from the status bar to open the quick access panel.

Monitoring Battery Usage

The **Battery** screen provides battery charge details, power management options, and a list of apps that consume the most battery power.

Use the power management options to extend battery life, or touch an app to display details about its power consumption. Different apps display different information. Some apps include buttons that open screens with settings to adjust power use. Use the **DISABLE** or **FORCE CLOSE** buttons to turn off apps that consume too much power.

1. Swipe down from the Status bar to open the Quick Settings bar and then touch .
2. Touch **Battery**.

Figure 29 Battery Screen



Low Battery Notification

When the battery charge level drops below , the device displays a notice to connect the device to power. The user should charge the battery using one of the charging accessories.

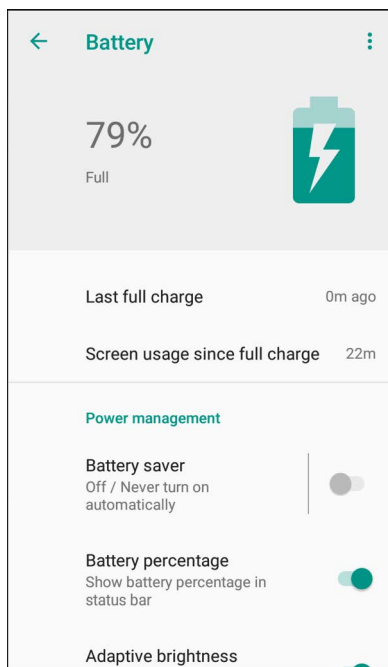
When the battery charge drops below 10%, the device displays a notice to connect the device to power. The user must charge the battery using one of the charging accessories.

When the battery charge drops below 4%, the device turns off. The user must charge the battery using one of the charging accessories.

Figure 30 Low Battery Notification

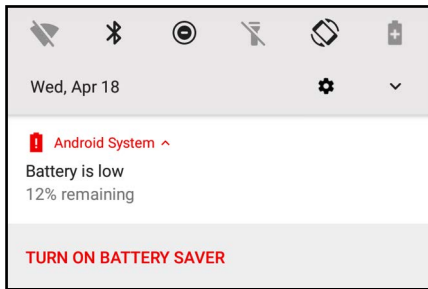

Battery Optimization

Observe the following battery saving tips:

- Set the screen to turn off after a short period of non-use.
- Reduce screen brightness.
- Turn off all wireless radios when not in use.
- Turn off automatic syncing for Email, Calendar, Contacts, and other apps.
- Minimize use of apps that keep the device from suspending, for example, music and video apps.

Turning Off the Radios

To turn off all the radios:

1. Swipe down from the Status bar to open the Quick Settings panel.
2. Touch **Airplane mode**. The airplane icon ✈ appears in the Status bar indicating that all the radios are off.

Setting the Date and Time

The date and time is automatically synchronized using an NITZ server when the device is connected to a cellular network. You are only required to set the time zone or set the date and time when not connected to a cellular network or if the wireless LAN does not support Network Time Protocol (NTP).

To set the date and time:

1. Swipe down from the Status bar to open the Quick Settings bar and then touch ⚙.
2. Touch **System > Date & time**.
3. Touch **Automatic date & time** to disable automatic date and time synchronization.
4. Touch **Automatic time zone** to disable automatic time zone synchronization.
5. Touch **Set date**.
6. In the calendar, set today's date.
7. Touch **OK**.

8. Touch **Set time**.
9. Touch the green circle, drag to the current hour and then release.
10. Touch the green circle, drag to the current minute and then release.
11. Touch **AM** or **PM**.
12. Touch **OK**.
13. Touch **Select time zone**.
14. Select the current time zone from the list.
15. Touch **Use 24-hour format**.
16. Touch .

Display Settings

Use Display settings to change the screen brightness, enable night light, change the background image, enable screen rotation, set sleep time, and change font size.

Setting the Screen Brightness

To manually set the screen brightness using the touchscreen:

1. Swipe down with two fingers from the Status bar to open the Quick Access panel.
2. Slide the icon to adjust the screen brightness level.

Figure 31 Brightness Slider



To let the device automatically adjust the screen brightness using the built-in light sensor:

1. Swipe down from the status bar to open the quick settings bar and then touch .
2. Touch **Display**.
3. If disabled, touch **Adaptive brightness** to automatically adjust the brightness.
By default, **Adaptive brightness** is enabled. Toggle the switch to disable.
4. Touch .

Setting Screen Timeout

To set the screen sleep time:

1. Swipe down from the Status bar to open the Quick Settings bar and then touch .
2. Touch **Display > Advanced > Sleep**.

3. Select one of the sleep values.
 - **15 seconds**
 - **30 seconds**
 - **1 minute** (default)
 - **2 minutes**
 - **5 minutes**
 - **10 minutes**
 - **30 minutes**
4. Touch .

Ambient Display

The Ambient display setting wakes the screen when notifications are received.

To disable ambient display:

1. Swipe down from the Status bar to open the Quick Settings bar and then touch .
2. Touch **Display** > **Advanced**.
3. Touch **Ambient display**.
4. In the **When to show** section, enable or disable an option using the switch.
5. Touch .

Setting Touch Key Light

The four touch keys under the screen are backlit.

To configure the touch key light to save battery power:

1. Swipe down from the Status bar to open the Quick Settings bar and then touch .
2. Touch **Display**.
3. Touch **Touch key light**.

4. Select an option to choose how long the touch key light stays on:
 - **Always off**
 - **6 seconds (default)**
 - **10 seconds**
 - **15 seconds**
 - **30 seconds**
 - **1 minute**
 - **Always on.**

Figure 32 Touch Key Light Dialog Box

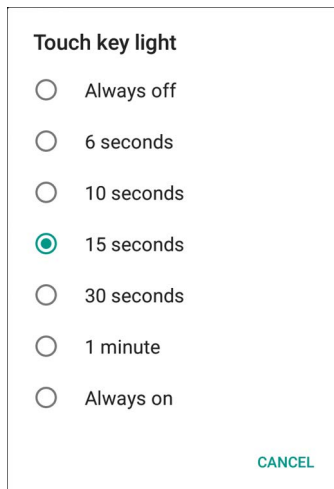

Touch key light

Always off

6 seconds

10 seconds

15 seconds

30 seconds

1 minute

Always on

CANCEL

5. Touch .

Setting Font Size

To set the size of the font in system apps:



1. Swipe down from the Status bar to open the Quick Settings panel and then touch .
2. Touch **Display > Advanced**.
3. Touch **Font size**.

Figure 33 Font Settings

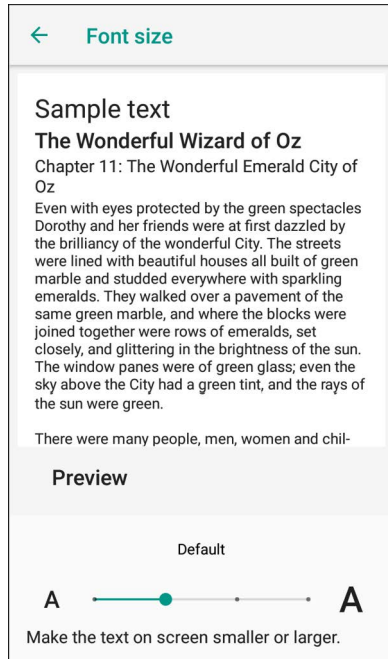

4. Select one of the font size values.
 - Small
 - Default
 - Large
 - Largest.
5. Touch .

Setting Screen Rotation

By default, screen rotation is enabled.

To disable screen rotation:

1. Swipe down from the Status bar to open the Quick Settings bar and then touch .
2. Touch **Display > Advanced**.
3. Touch **Auto-rotate screen**.



NOTE: To change the Home screen rotation, see Setting Home Screen Rotation.

4. Touch .

Touch Panel Mode

The device display is able to detect touches using a finger, a conductive-tip stylus, or gloved finger.



NOTE: A glove can be made of medical latex, leather, cotton, or wool.

For optimal performance use a Zebra certified stylus.

1. Swipe down from the Status bar to open the Quick Settings bar and then touch .
2. Touch **Display > Advanced**.
3. Touch **Touch panel mode**.

Figure 34 Screen Protector Mode Dialog Box

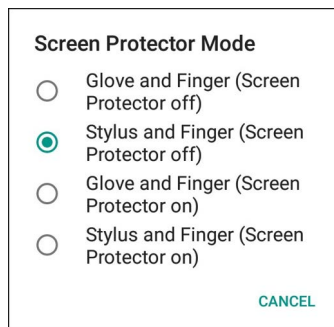

4. Select:
 - a. **Glove and Finger (Screen Protector off)** to use a finger or a gloved finger on the screen without a screen protector.
 - b. **Stylus and Finger (Screen Protector off)** to use a finger or a stylus on the screen without a screen protector.
 - c. **Glove and Finger (Screen Protector on)** to use a finger or a gloved finger on the screen with a screen protector.
 - d. **Stylus and Finger (Screen Protector on)** to use a finger or a stylus on the screen with a screen protector.
5. Touch .

Setting Display Size

By default, display size is set to default.

To change the display size:

1. Swipe down from the Status bar to open the Quick Settings bar and then touch .
2. Touch **Display > Advanced**.
3. Touch **Display size**.

4. Touch - and + to change the display size.
 - Small
 - Default
 - Large.
5. Touch ○.

General Sound Setting

Use the **Sound** settings to configure media and alarm volumes.

To access sound settings:

1. Swipe down from the Status bar to open the Quick Settings bar and then touch ⚙️.
2. Touch **Sound**.
3. Touch an option to set sounds.

Figure 35 Sound Screen

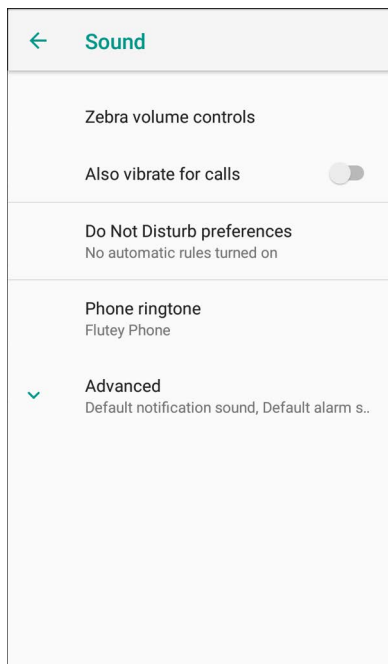



- **Zebra volume controls**
 - **Ring volume** - Controls the ringtone volume.
 - **Media volume** - Controls the music, games, and media volume.
 - **Alarm volume** - Controls the alarm clock volume.
 - **Notifications volume** - Controls the notification volume.
 - **Scanner volume** - Controls the scanner volume.
 - **Volume presets**
 - 🚫 - Mutes the ring, notifications, and scanner so that the device does not make sounds or vibrate.
 - 📞 - All sounds except media and alarms are silenced and vibrate mode is active.
 - 🔔 - Enables all sounds at the user defined levels.

- Also vibrate for calls - Switch on or off.
- **Do Not Disturb preferences** - Mutes some or all sounds and vibrations.
 - **Priority only allows** - Use to set the priorities for the following:
 - **Reminders** - Switch on or off.
 - **Events** - Switch on or off.
 - **Alarms** - This is always enabled.
 - **Messages** - Choose to allow messages from anyone, starred contacts, any contact, or none. To star contacts, use the Contacts app.
 - **Calls** - Choose to allow calls from anyone, starred contacts, any contact, or none. To star contacts, use the Contacts app.
 - **Repeat callers** - Choose whether or not the phone rings if the same person calls again within 15 minutes.
 - **Block visual disturbances**
 - **Block when screen is on** - This option prevents notifications from displaying over the screen (peeking) while you are actively using the device.
 - **Block when screen is off** - This option prevents notifications from turning on the screen or pulsing the LED light when a new notification is received while you are not using the device.
 - **Automatic rules** - Choose when to automatically silence the device. Touch a default rule, such as Weekend or Weeknight, or create your own rule. To create your own rule, tap **Add more** and then **Time rule**.
- **Phone ringtone** - Touch to select a sound to play when the phone rings.
- **Advanced** - Touch to display advanced sound options.
 - **Default notification sound** - Touch to select a sound to play for all system notifications.
 - **Default alarm sound** - Touch to select a sound to play for alarms.
 - **Other sounds and vibrations**
 - **Dial pad tones** - Play a sound when pressing keys on dial pad (default - disabled).
 - **Screen locking sounds** - Play a sound when locking and unlocking the screen (default – enabled).
 - **Charging sounds** - Not applicable.
 - **Touch sounds** - Play a sound when making screen selections (default – enabled/enabled).
 - **Vibrate on tap** - Vibrate the device when making screen selections (default – disabled).
 - **Emergency alerts** - Touch to configure emergency broadcast settings and notifications.

Wake-Up Sources

By default the device wakes from suspend mode when the user presses the power button. The device can be configured to wake when the user presses the PPT or Scan buttons on the left side of the device.

1. Swipe down with two fingers from the status bar to open the quick access panel and then touch .
2. Touch  **Wake-Up Sources**.
3. Touch **SCAN** checkbox. A check appears in the checkbox.
4. Touch **SCANTRIG_KEY** checkbox. A check appears in the checkbox.

5. Touch **LEFT_TRIGGER_2** checkbox. A check appears in the checkbox.

Figure 36 Wake-Up Sources

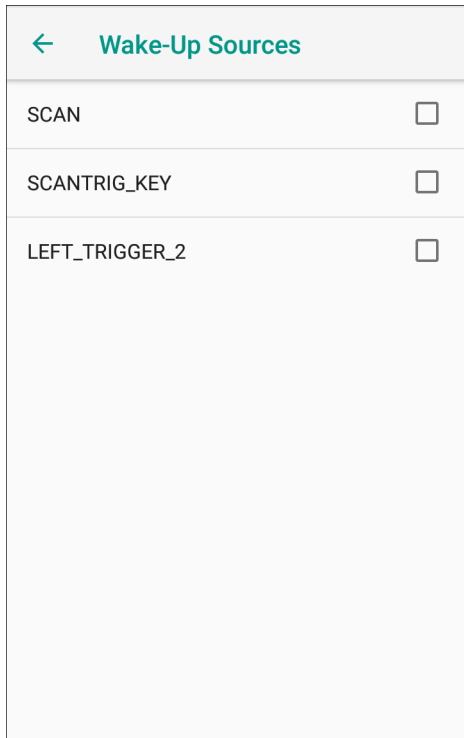

6. Touch ○.

Using the Device

This section explains how to use the device.

Google Mobile Services



NOTE: This section applies to Google Mobile Services (GMS) devices only.

Devices with GMS contain apps and services that provide additional functionality.

GMS includes:

- Apps - GMS adds a variety of Google apps and associated widgets including Chrome, Gmail, Drive, and Maps.
- Services:
 - Speech to Text - Allows for free format speech to text in many languages for both connected and disconnected network. Launch by touching the microphone icon on the keyboard.
 - TalkBack Service - Provides spoken feedback on various parts of the user interface. To enable, go to **Settings > Accessibility**.
 - Network Location Provider - Adds a location provider which uses mobile network tower information and Wi-Fi access point information to provide a location without using GPS. To enable, go to **Settings > Security & location > Location**.
 - Widevine DRM - Enables Digital Rights Management (DRM) so that protected streaming video content can be played. Enable DRM Info from the Google Play™ store.
 - Google Cloud Messaging - Allows the device to receive data from the server and other devices on the same connection.
 - Backup and Restore - Allows the users settings and apps to be backed up to a Google server and subsequently restored from that server after a factory reset.
- Google Accounts - Create and use a Google account to synchronize mail, files, music, photos, contacts and calendar events.

Home Screen

Turn on the device to display the Home screen. Depending on the configuration, the Home screen may appear different. Contact your system administrator for more information.

After a suspend or screen time-out, the Home screen displays with the lock slider. Touch the screen and slide up to unlock. For screen locking information, see Un-Locking the Screen.

The Home screen provides additional screens for placement of widgets and shortcuts. Swipe the screen left or right to view the additional screens.



NOTE: By default, non-GMS devices do not have the same icons on the Home screen as GMS. Icons are shown below for example only.

Home screen icons can be configured by the user and may look different than shown.

Figure 37 Home Screen



Table 4 Home Screen Features

	Item	Description
1	Status Bar	Displays the time, status icons (right side), and notification icons (left side). For more information see Status Icons on page 46 and Managing Notifications on page 49 .
2	Widgets	Launches stand-alone apps that run on the Home screen.
3	Shortcut Icons	Opens apps installed on the device.
4	Folder	Contains apps.
5	All Apps	Opens the APPS window.

The Home screen provides four additional screens to place widgets and shortcuts. Swipe the screen left or right to view the additional screens.

Setting Home Screen Rotation

By default the **Home** screen rotation is disabled.

To enable **Home** screen rotation:

1. Touch and hold anywhere on the **Home** screen until the options appear.
2. Touch **HOME SETTINGS**.
3. Touch the **Allow Home screen rotation** switch.
4. Touch .
5. Rotate the device.

Figure 38 Rotated Home Screen

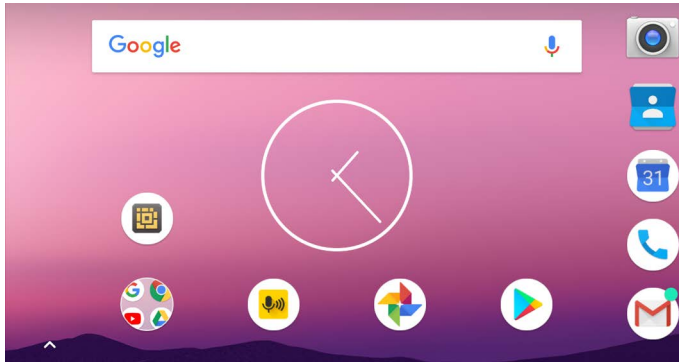

Status Bar

The Status bar displays the time, notification icons (left side), and status icons (right side).



NOTE: Some Status icons may not appear in the Status bar if there are too many icons to display.

Figure 39 Notification and Status Icons



If there are more notifications than can fit in the Status bar, two dots display indicating that more notifications exist. Swipe down from the Status bar to open the Notification panel and view all notifications and status.























Status Icons

Table 5 Status Icons

Icon	Description
	Alarm is active.
	Main battery is fully charged.
	Main battery is partially drained.

¹Cellular network icon that appears is dependent upon the carrier/network.























Table 5 Status Icons (Continued)

Icon	Description
	Main battery charge is low.
	Main battery charge is very low.
	Main battery is charging.
	All sounds, except media and alarms, are silenced and vibrate mode is active.
	Do Not Disturb mode active.
	Airplane Mode is active. All radios are turned off.
	Bluetooth is on.
	The device is connected to a Bluetooth device.
	Connected to a Wi-Fi network.
	Not connected to a Wi-Fi network or no Wi-Fi signal.
	Connected to an Ethernet network.
	Speakerphone enabled.
	Portable Wi-Fi hotspot is active (WWAN only).
	Connected to a 4G LTE/LTE-CA network (WWAN only) ¹ .
	Connected to a DC-HSPA, HSDPA, HSPA+, HSUPA, LTE/LTE-CA or WCDMA network (WWAN only) ¹ .
	Connected to a 1x-RTT (Sprint), EGDGE, EVDO, EVDV or WCDMA network (WWAN only) ¹ .
	Connected to a DC - HSPA, HSDPA, HSPA+ or HSUPA network (WWAN only) ¹ .
	Connected to an EDGE network (WWAN only) ¹ .
	Connected to a GPRS network (WWAN only) ¹ .
	
	Connected to a 1x-RTT (Verizon) network (WWAN only) ¹ .
	Roaming from a network (WWAN only).
	No SIM card installed (WWAN only).

¹Cellular network icon that appears is dependent upon the carrier/network.

Notification Icons

Table 6 *Notification Icons*

Icon	Description
	Main battery is low.
..	More notifications are available for viewing.
	Data is syncing.
	Indicates an upcoming event. Non-GMS devices only.
	Indicates an upcoming event. GMS devices only.
	Open Wi-Fi network is available.
	Song is playing.
	Problem with sign-in or sync has occurred.
	Device is uploading data.
	Device is downloading data when animated and download is complete when static.
	Device is connected via USB cable.
	Device is connected to or disconnected from virtual private network (VPN).
	Preparing internal storage by checking it for errors.
	USB debugging is enabled on the device.
	Call is in progress.
	One or more voice message is in mailbox.
	Call is on hold.
	Call was missed.
	Headset is connected to the device.
	PTT Express Voice client status. See the PTT Express PTT Notification Icons for a complete list.
	Indicates that RxLogger app is running.
	Indicates the Bluetooth scanner is connected to the device.
	Indicates the RS507/RS507X or RS6000 is connected to the device in HID mode.

Managing Notifications

Notification icons report the arrival of new messages, calendar events, alarms, and ongoing events. When a notification occurs, an icon appears in the Status bar with a brief description. See Notification Icons for a list of possible notification icons and their description. Open the Notification panel to view a list of all the notifications.

To open the Notification panel, drag the Status bar down from the top of the screen.

Figure 40 Notification Panel

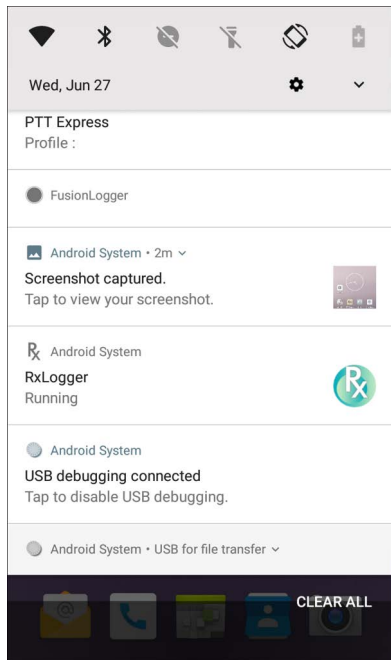

To respond to a notification, open the Notification panel and then touch a notification. The Notification panel closes and the corresponding app opens.

To clear all notifications, open the Notification panel and then touch **CLEAR ALL**. All event-based notifications are removed. Ongoing notifications remain in the list.

To close the Notification panel, swipe the Notification panel up.

Setting App Notifications

To set notification settings for a specific app:

1. Swipe down from the Status bar to open the Quick Settings bar and then touch .
2. Touch **Apps & notifications > Notifications > App notifications**.
3. Select an app.

4. Select an available option:
 - **On / Off** - Select to turn all notifications from this app **On** (default) or **Off**.
 - **Allow notification dot** - Do not allow this app to add a notification dot to the app icon.
 - **Allow interruptions** - Do not allow notifications from this app to make sound, vibrate, or pop notifications on the screen.
 - **Override Do Not Disturb** - Allow these notifications to interrupt when Do Not Disturb is set to Priority Only.
 - **Categories** - Do not allow specific types of notifications from this app.
 - **Additional settings in the app** - Open the app settings.



NOTE: To change the notification settings for an app, slide the notification slightly left or right and touch .

Viewing Notification Settings for All Apps

To view the notification settings for all apps:

1. Swipe down from the Status bar to open the Quick Settings bar and then touch .
2. Touch **Apps & Notifications**.
3. Scroll down to **Notifications** to view how many apps have notifications turned off.
4. To set or view notifications settings for a specific app, see Setting App Notifications.

Controlling Lock Screen Notifications

To control whether notifications can be seen when the device is locked:

1. Swipe down from the Status bar to open the Quick Settings bar and then touch .
2. Touch **Apps & notifications > Notifications**.
3. Touch **On the lock screen** and select one of the following:
 - **Show all notification content** (default)
 - **Don't show notifications at all**.

Blink Light

The Notification LED lights blue when an app, such as email and VoIP, generates a programmable notification or to indicate when the device is connected to a Bluetooth device. By default, LED notifications are enabled.

To change the notification setting:

1. Swipe down from the Status bar to open the Quick Settings bar and then touch .
2. Touch **Apps & notifications > Notifications**.
3. Touch **Blink light** to toggle the notification on or off.

Quick Access Panel

Use the Quick Access panel to access frequently used settings (for example, Airplane mode).

Figure 41 Quick Settings Bar

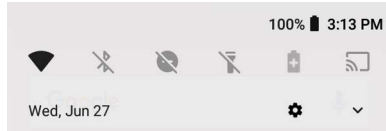

To see the full Quick Access panel:

- If the device is locked, swipe down once.
- If the device is unlocked, swipe down once with two fingers, or twice with one finger.
- If the Quick Settings bar is open, touch the Down arrow.

Figure 42 Quick Access Panel

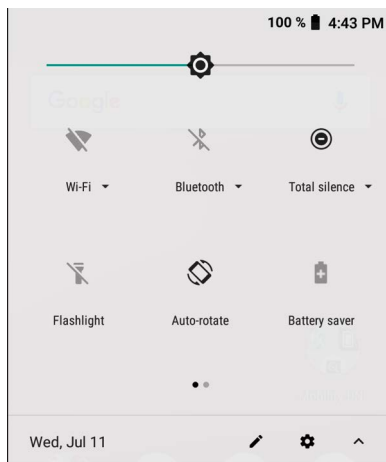

NOTE: Not all icons are pictured. Icons may vary.

To change a setting, touch the icon:



- Display brightness - Use the slider to decrease or increase the brightness of the screen.
- Wi-Fi network - Turn Wi-Fi on or off. To open Wi-Fi settings, touch the Wi-Fi network name.
- Bluetooth settings - Turn Bluetooth on or off. To open Bluetooth settings, touch **Bluetooth**.
- Battery saver - Turn Battery saver mode on or off. When Battery saver mode is on the performance of the device is reduced to preserve battery power.
- Do not disturb - Control how and when to receive notifications.
- Mobile data - Turns cellular radio on or off. To open Mobile data settings, touch and hold(WAN only).
- Airplane mode - Turn Airplane mode on or off. When Airplane mode is on the device does not connect to Wi-Fi or Bluetooth.

- Flashlight - Turn flashlight on or off. Turn camera flash on or off.
The thermal protection safety feature for the camera provides the following behavior if the temperature range is 40°C or above:
 - If the flashlight is kept on for a certain period of time, it is automatically turned off and cannot be turned back on for a period of time until it has cooled off.
 - During the cooling off period, the camera cannot be turned on. If you attempt to use the camera, a message displays indicating to try again after a period of time.
- Hotspot - Turn on to share the device's mobile data connection with other devices.
- Cast - Share phone content on Chromecast or a television with Google Cast built-in. Touch cast screen to display a list of devices, then touch a device to begin casting.



Editing Icons on Quick Settings

The first several setting tiles from the Quick Access panel become the Quick Settings bar.



To move a setting tile:

1. Open the Quick Access panel.
2. Touch .
3. Touch and drag a setting tile to another location.
4. Release the tile.
5. Touch  to save tiles and return to the Quick Access panel.

To add a setting tile:

1. Open the Quick Access panel.
2. Touch .
3. Slide the Quick Settings panel up to reveal additional tiles.
4. Touch and drag a setting tile from the **Drag to add tiles** area to the main area.
5. Release the tile.
6. Touch  to save tiles and return to Quick Access panel.

To remove a setting tile:

1. Open the Quick Access panel.
2. Touch .
3. Touch and drag a setting tile to the **Drag here to remove** area.
4. Release the tile.
5. Touch  to save tiles and return to Quick Access panel.

App Shortcuts and Widgets

App shortcuts placed on the Home screen allow quick and easy access to apps. Widgets are self-contained apps placed on the Home screen to access frequently used features.

Adding an App Shortcut to the Home Screen

To add an app shortcut to the Home screen:

1. Go to the desired Home screen.
2. Swipe up from the bottom of the screen.
3. Scroll through the list to find the app icon.
4. Touch and hold the icon until the Home screen appears.
5. Position the icon on the screen and then release.

Adding a Widget to the Home Screen

To add a widget to the Home screen:

1. Go to the desired Home screen.
2. Touch and hold until the menu appears.
3. Touch **WIDGETS**.
4. Scroll through the list to find the widget.
5. Touch and hold the widget until the Home screen appears.
6. Position the widget on the screen and then release.

Moving Items on the Home Screen

To move app shortcuts or widgets on the Home screen:

1. Touch and hold the item until it floats on the screen.
2. Drag the item to a new location. Pause at the edge of the screen to drag the item onto an adjacent Home screen.
3. Lift finger to place the item on the Home screen.

Removing an App Shortcut or Widget from the Home Screen

To remove an app shortcut or widget from the Home screen:

1. Go to the desired Home screen.
2. Touch and hold the app shortcut or widget icon until it floats on the screen.
3. Drag the icon to **X Remove** at the top of the screen and then release.

Folders

Use **Folders** to organize similar applications together. Tap the folder to open and display items in the folder.

Creating a Folder

There must be at least two app icons on the Home screen.

To create a folder:

1. Go to the desired Home screen.
2. Touch and hold one app icon.
3. Drag the icon and stack on top of another icon.
4. Lift and release.

Naming Folders

To name a folder:

1. Touch the folder.

Figure 43 Open Folder

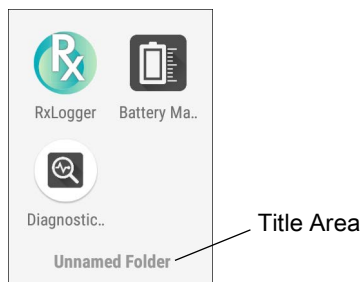

2. Touch the title area and enter a folder name using the keyboard.
3. Touch  on the keyboard.
4. Touch anywhere on the Home screen to close the folder. The folder name appears under the folder.

Removing a Folder

To remove a folder:

1. Touch and hold the folder icon until it enlarges.
2. Drag the folder to **X Remove** and release.

Home Screen Wallpaper

To change the Home screen wallpaper:

1. Touch and hold the screen until the menu appears.
2. Touch **WALLPAPERS**.
3. Touch **Photos** or **Gallery** to select a photo or select one of the pre-installed wallpapers.
4. Touch **Set wallpaper**.

Using the Touchscreen

Use the multi-tap sensitive screen to operate the device.

- Tap - Tap to:
 - Select items on the screen.
 - Type letters and symbols using the on-screen keyboard.
 - Press on-screen buttons.
- Tap and Hold - Tap and hold:
 - An item on the Home screen to move it to a new location or to the trash.
 - An item in Apps to create a shortcut on the Home screen.
 - The Home screen to open a menu for customizing the Home screen.
 - An empty area on the Home screen until the menu appears.
- Drag - Tap and hold an item for a moment and then move finger on the screen until reaching the new position.
- Swipe - Move finger up and down or left and right on the screen to:
 - Unlock the screen.
 - View additional Home screens.
 - View additional app icons in the Launcher window.
 - View more information on an app's screen.
- Double-tap - Tap twice on a web page, map, or other screen to zoom in and out.
- Pinch - In some apps, zoom in and out by placing two fingers on the screen and pinching them together (to zoom out) or spreading them apart (to zoom in).

Keyboards

The device provides the following types of keyboards:

- Android Keyboard - Non-GMS devices only.
- Gboard - GMS devices only
- Enterprise Keyboard



NOTE: By default the Enterprise and Virtual Keyboards are disabled.

Keyboard Configuration



Enabling Keyboards

To enable keyboards:

1. Swipe down from the Status bar to open the Quick Settings bar and then touch .
2. Touch **System > Languages & input > Virtual keyboard > Manage keyboards**.
3. Touch a keyboard to enable.

Switching Between Keyboards

To switch between keyboards, touch in a text box to display the current keyboard.

- On the Android or Gboard keyboards, touch and hold .
- On the Enterprise keyboard, touch .

Using the Android and Gboard Keyboards

Use the Android or Gboard keyboards to enter text in a text field. To configure the keyboard settings, touch and hold , (comma) and then select **Android keyboard settings**.

Editing Text

Edit entered text and use menu commands to cut, copy, and paste text within or across apps. Some apps do not support editing some or all of the text they display; others may offer their own way to select text.

Entering Numbers, Symbols, and Special Characters

To enter numbers and symbols:

- Touch and hold one of the top-row keys until a menu appears then select a number or special character.
- Touch the Shift key once for a single capital letter. Touch the Shift key twice to lock in uppercase. Touch the Shift key a third time to unlock Capslock.
- Touch **?123** switch to the numbers and symbols keyboard.
- Touch the **=\<** key on the numbers and symbols keyboard to view additional symbols.

To enter special characters, touch and hold a number or symbol key to open a menu of additional symbols. A larger version of the key displays briefly over the keyboard.

Using the Enterprise Keyboard

The Enterprise Keyboard contains the following keyboards:

- Numeric
- Alpha
- Special characters
- Data capture.

Numeric Tab

To access the numeric keyboard, touch the **123** tab. The keys displayed vary on the app being used. For example, an arrow displays in **Contacts**, however **Done** displays in **Email** account setup.

Figure 44 Numeric Keyboard

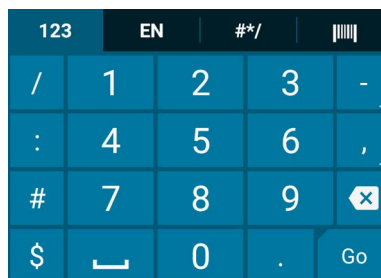
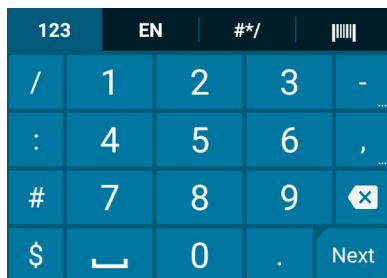

Alpha Tab

To access the alpha keyboard, touch the EN tab.

Figure 45 Alpha Keyboard



Additional Character Tab

To access additional characters, touch the **#*/** tab.

Figure 46 Symbols Keyboard



Touch 😊 to enter emoji icons in a text message.

Figure 47 Emoji Keyboard

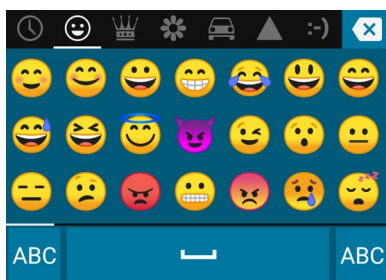

Touch **ABC** to return to the Symbols keyboard.

Scan Tab

The Scan tab provides an easy data capture feature for scanning barcodes.

Figure 48 Scan Keyboard

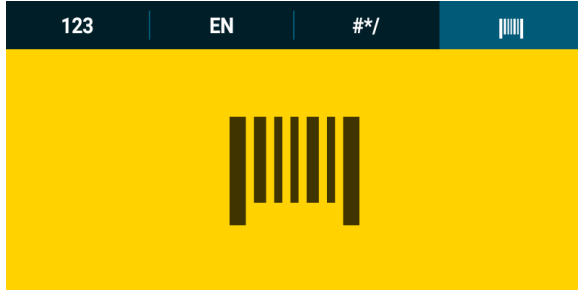

Do Not Disturb Feature

This mode mutes the device so that it does not make sounds or vibrate.

For example, use Do Not Disturb to:

- Automatically limit sounds at night or during events
- Mute interruptions other than alarms
- Get alerted to messages only from favorite contacts.

Limit Sounds and Vibrations

Mute the device completely, or let through the important alarms or important calls.

Total Silence

To completely mute the device so that it does not make a sound or vibrate, choose **Total silence**.

In Total silence mode:

- Alarms do not make noise.
- Device does not vibrate or make sounds when receiving a message, or notification.
- Sounds from music, videos, games, and other media are muted.



NOTE: All alarms are silenced in Total silence mode.

1. Swipe down with two fingers from the Status bar to open the Quick Access panel.
2. Touch **Do not disturb** > **Total silence**.
3. Choose **Until you turn it off** or select a time period.
4. Touch **Done**.

When Total Silence is on,  appears in the quick access panel and the Status bar.

To turn off Total Silence, open quick access panel and touch **Total silence**.

Alarms Only

To mute the device so that you hear alarms, choose **Alarms only**. This option does not mute sounds from music, videos, games, or other media.

1. Swipe down with two fingers from the status bar to open the quick access panel.
2. Touch **Do not disturb > Alarms only**.
3. Choose **Until you turn it off** or select a time period.
4. Touch **Done**.

When Alarms Only is on,  appears in the quick access panel and the Status Bar.

To turn off Alarms Only, open the Quick Access panel and touch **Alarms only**.



NOTE: To quickly turn on Alarms Only, with the screen on, press and hold the Volume Down button until the volume is all the way down. Then, press Volume Down again to turn on Alarms Only.

To turn off Alarms Only, press either the Volume Up or Volume Down button and the touch **END NOW** in the alert message.

Priority Notifications Only

To only be interrupted by important notifications, choose **Priority only**. This option does not mute sounds from music, videos, games, or other media.

Before turning on Priority Only mode, set the notification priorities:

1. Swipe down from the status bar to open the quick settings bar and then touch .
2. Touch **Sound > Do not disturb > Priority only allows**.
3. Set priorities.
 - **Alarms:** Disabled by default.
 - **Reminders and Events:** Switch on or off.
 - **Messages and Calls:** Choose **From anyone**, **From contacts only**, **From starred contacts only**, or **none**. To star contacts, use the **Contacts** applications.
 - **Repeat callers:** Choose whether to let the device ring if the same person calls again within 15 minutes.

After setting notification priorities, turn on Priority Only mode to limit interruptions. The priority notifications make a sound or vibrate based on the current ringer volume, but other notifications will be silenced.

1. Swipe down with two fingers from the status bar to open the quick access panel.
2. Touch **Do not disturb > Priority only**.
3. Choose **Until you turn it off** or select a time period.
4. Tap **Done**.

When Priority Only is on,  appears in the quick access panel and the Status Bar.

To turn off Priority Only, open quick access panel and touch **Priority only**.

Automatically Block Sounds and Vibrations

Automatically silence the device during certain times or events, turn sounds back on, and override Do Not Disturb mode.

Silence Sounds During Certain Times

To automatically silence the device during certain times, like at night or on weekends:



1. Swipe down from the Status bar to open the Quick Settings bar and then touch .
2. Touch **Sound > Do Not Disturb preferences**.
3. Touch a default **Weekend** or **Weeknight**. Or, to make a new rule, touch **Add more > Time rule**.
4. Enter a rule name.
5. Touch **OK**.
6. Edit the new rule:
 - **Rule name** - Rename the rule.
 - **Days, Start time, and End time** - Set the rule's schedule.
 - **Do Not Disturb preferences** - Choose whether the rule uses **Alarms only**, **Priority only**, or **Total silence**.
 - **Alarm can override end time** - Allow the alarm to continue to make sound until the next alarm begins.
7. Touch the On/Off switch at the top to turn on the rule.

Silence Sounds During Events and Meetings

To automatically silence the device during events or meetings, set an event rules.

1. Swipe down from the Status bar to open the Quick Settings bar and then touch .
2. Touch **Sound > Do Not Disturb preferences**.
3. To edit the default rule, touch **Event**. Or, to create a new rule, touch **Add rule > Event rule**.
4. Edit the rule settings.
 - **Rule name** - Rename the rule.
 - **During events for** - Select which Google Calendar events the rule uses.
 - **Where reply is** - Set to: **Yes, Maybe, or Not replied**, **Yes or Maybe**, or **Yes**.
 - **Do Not Disturb preferences** - Choose whether the rule uses **Priority only**, **Alarms only**, or **Total silence**.
5. Touch the On/Off switch at the top to turn on the rule.

Turn Sounds Back On

When the device is in Do Not Disturb mode, Alarms only or Priority only display as , or Total silence displays as .

To turn off Do Not Disturb, either:

- In the Quick Access panel, touch **Alarms only**, **Priority only**, or **Total silence**.
- Press the Volume Down button and touch **End Now**.

Override Do Not Disturb for Specific Apps

To let through notifications from specific apps:

1. Swipe down from the Status bar to open the Quick Settings bar and then touch .
2. Touch **Apps & notifications > Notifications > App notifications**.
3. Touch an app.
4. Touch **Override Do Not Disturb**.

Apps

The **APPS** screen displays icons for all installed apps. The table below lists the apps installed on the device. Refer to the device Integrator Guide for Android Version 8.1 for information on installing and uninstalling apps.

Table 7 Apps









Icon	Description
	Battery Manager - Displays battery information, including charge level, status, health and wear level.
	Battery Swap – Use to place device in Battery Swap mode when replacing the battery.
	Bluetooth Pairing Utility – Use to pair the RS507 Hands-free Imager with the device by scanning a barcode.
	Calculator - Provides the basic and scientific arithmetic functions.
	Calendar - Use to manage events and appointments. GMS devices only
	Calendar - Use to manage events and appointments. Non-GMS devices only.
	Camera - Take photos or record videos. For more information see Camera.
	Chrome - Use to access the Internet or intranet. GMS devices only
	Chromium - Use to access the Internet or intranet. Non-GMS devices only.

Table 7 Apps (Continued)









Icon	Description
	Clock - Use to schedule alarms for appointments or as a wake-up.
	Contacts - Use to manage contact information. See Contacts for more information.
	DataWedge - Enables data capture using the imager.
	Device Central - Use to display detailed information about the device and connected peripherals. See Device Central for more information.
	Diagnostic Tool - Use to diagnose the device.
	Drive - Upload photos, videos, documents, and other files to personal storage site. GMS devices only
	Duo - A one-to-one video calling app (WWAN only).
	DWDemo - Provides a way to demonstrate the data capture features using the imager. See DataWedge Demonstration for more information.
	Email - Use to send and receive email. Non-GMS devices only.
	Files - Organize and manage files on the device. See Files for more information.
	Gallery - Use to view photos stored on the microSD card. For more information, see Gallery for more information. Non-GMS devices only.
	Gmail - Use to send and receive email using a Google email account. GMS devices only
	Google - Launches Google™ search app. GMS devices only
	Keep - Use to create, edit, and share notes. GMS devices only

Table 7 Apps (Continued)





















Icon	Description
	License Manager - Use to manage software licenses on the device.
	Maps - Use to see your location on a map (with public transit, traffic, or satellite overlays). Search for any business or place of interest. Provides turn-by-turn navigation with voice guidance, traffic-avoidance, and alternate routes, for drivers, cyclists, walkers, and users of public transportation. GMS devices only
	Messaging - Send SMS and MMS messages. See Messaging for more information. WAN devices only.
	MSRN - Use to verify authenticity of the paired Snap-on MSR and to provision the Snap-on MSR. See device Touch Computer Integrator Guide for Android Version 8.1 for more information.
	Music - Play music stored on the microSD card or internal storage. Non-GMS devices only.
	Notes - Use to take and save notes. Non-GMS devices only
	Phone - Use to dial a phone number when used with some Voice over IP (VoIP) clients (VoIP telephony ready only).
	Photos - Use to sync photos with Google account. For more information, see Photo Settings. GMS devices only
	Play Movies & TV - View movies and video on your device. GMS devices only
	Play Music - Use to listen to music. GMS devices only
	Play Store - Download music, movies, books, and Android apps and games from the Google Play Store. GMS devices only
	PTT Express - Use to launch PTT Express client for VoIP communication.
	RxLogger - Use to diagnose device and app issues. See the device Integrator Guide for Android Version 8.1 for more information.
	RxLogger Utility - Use to view, backup, and archive RxLogger data.

Table 7 Apps (Continued)

Icon	Description
	Search - Use to search the Web. Requires an Internet connection. Non-GMS devices only.
	Settings - Use to configure the device.
	SimulScan Demo - Use to demonstrate the document capture feature of the device.
	Sound Recorder - Use to record audio.
	StageNow - Allows the device to stage a device for initial use by initiating the deployment of settings, firmware, and software.
	YouTube - Use to view videos on the YouTube™ web site. GMS devices only
	Zebra Bluetooth - Use to configure Bluetooth logging.

Accessing Apps

All apps installed on the device are accessed using the **APPS** window.

1. On the Home screen, swipe up from the bottom of the screen.

Figure 49 APPS Window Example

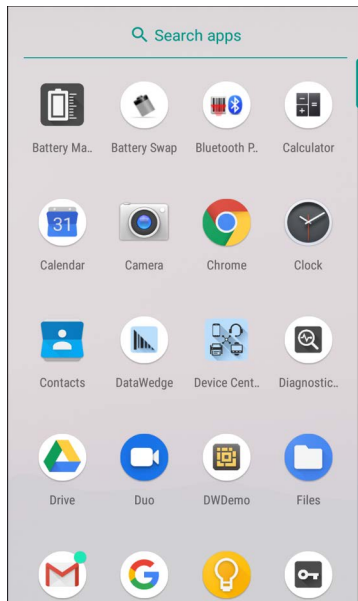

Slide the **APPS** window up or down to view more app icons. Touch an icon to open the app.

Switching Between Recent Apps

To switch between recent apps:

1. Touch . A window appears on the screen with icons of recently used apps.

Figure 50 Recently Used Apps



2. Slide the apps displayed up and down to view all recently used apps.
3. Swipe left or right to remove app from the list and force close the app.
4. Touch an icon to open an app or touch ◀ to return to the current screen.

Un-Locking the Screen

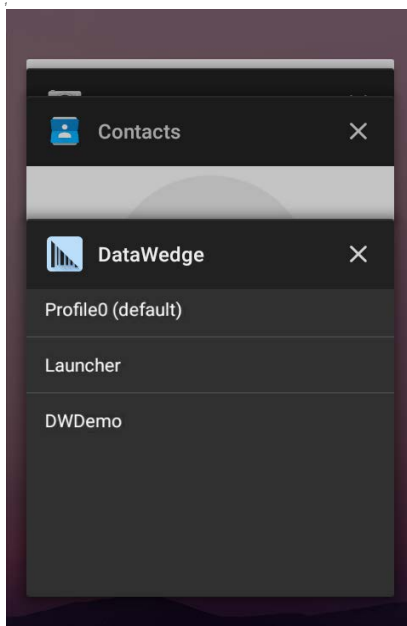
Use the Lock screen to protect access to data on the device. Some email accounts require locking the screen. Refer to the device Integrator Guide for information on setting up the locking feature.

When locked, a pattern, PIN, or password is required to unlock the device. Press the Power button to lock the screen. The device also locks after a pre-defined time-out.

Press and release the Power button to wake the device. The Lock screen displays. Swipe the screen up to unlock. If the Pattern screen unlock feature is enabled, the Pattern screen appears instead of the Lock screen. If the PIN or Password screen unlock feature is enabled, enter the PIN or password after unlocking the screen.

Figure 51 Lock Screen



Figure 52 PIN Screen

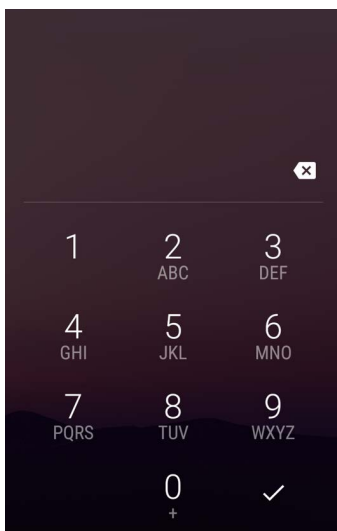

Figure 53 Pattern Screen

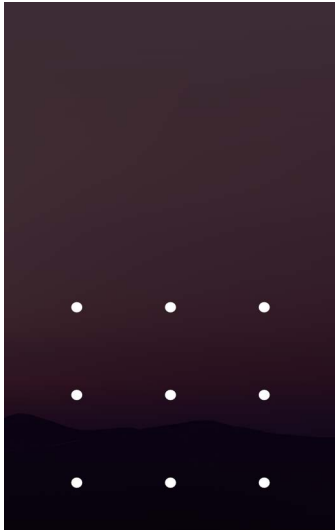
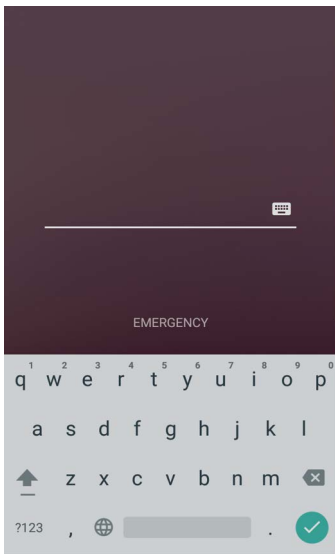

Figure 54 Password Screen



Interactive Sensor Technology

The device contains sensors that monitor movement, orientation and ambient light:

- Gyroscope - Measures angular rotational velocity to detect rotation of the device.
- Accelerometer - Measures the linear acceleration of movement to detect the orientation of the device.
- Digital Compass - The digital compass or magnetometer provides simple orientation in relation to the Earth's magnetic field. As a result, the device always knows which way is North so it can auto rotate digital maps depending on the physical orientation of the device.
- Light Sensor - Detects ambient light and adjusts the screen brightness.
- Proximity Sensor - Detects the presence of nearby objects without physical contact.

In order to take advantage of these sensors, applications use API commands. Refer to the Zebra Android EMDK for more information.

Resetting the Device

There are two reset functions, soft reset and hard reset.

Performing a Soft Reset

Perform a soft reset if applications stop responding.

1. Press and hold the Power button until the menu appears.
2. Touch **Restart**.
3. The device reboots.

Performing a Hard Reset



CAUTION: Performing a hard reset with a SD card installed in the device may cause damage or data corruption to the SD card.

Perform a hard reset if the device stops responding.

1. Simultaneously press the Power, Scan and Volume Up buttons for at least four seconds.
2. When the screen turns off, release the buttons.
3. The device reboots.

Suspend Mode

The device goes into suspend mode when you press the Power button or after a period of inactivity (set in the Display settings window).

To wake the device from Suspend mode, press the Power button. The Lock screen displays. Swipe the screen up to unlock. If the Pattern screen unlock feature is enabled, the Pattern screen appears instead of the Lock screen. If the PIN or Password screen unlock feature is enabled, enter the PIN or password after unlocking the screen. See Un-Locking the Screen.



NOTE: If you enter the PIN, password, or pattern incorrectly five times, you must wait 30 seconds before trying again. If you forget the PIN, password, or pattern contact your system administrator.

Transferring Files with a Host Computer via USB

Connect the device to a host computer using a USB cable or a USB cradle to transfer files between the device and the host computer.

When connecting the device to a host computer, follow the host computer's instructions for connecting and disconnecting USB devices, to avoid damaging or corrupting files.

Transferring Files



NOTE: Use Transfer files to copy files between the device (internal memory or microSD card) and the host computer.

1. Connect a USB cable to the device or place the device into a USB cradle.
2. Pull down the Notification panel and touch **USB charging this device**.
By default, **Charge this device** is selected.

Figure 55 Use USB to Dialog Box

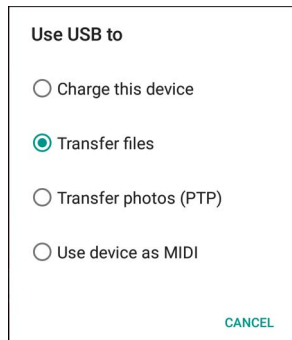

3. Touch **Transfer files**.
4. On the host computer, open a file explorer application.
5. Locate the **device** as a portable device.
6. Open the **SD card** or the **Internal storage** folder.
7. Copy files to and from the device or delete files as required.

Transferring Photos

To transfer photos using Photo Transfer Protocol:



NOTE: Use Photo Transfer Protocol (PTP) to copy photos from either the microSD card or internal memory to the host computer.

1. Connect USB cable to the device or place the device into a USB cradle. See [This section provides information for using the accessories for the device. The following table lists the accessories available for the device.](#) for setup information.
2. Pull down the Notification panel and touch **USB charging this device**.
3. Touch **Transfer photos (PTP)**.
4. On the host computer, open a file explorer application.
5. Open the **SD card** or the **Internal storage** folder.
6. Copy or delete photos as required.

Disconnect from the Host Computer

To disconnect the device from the host computer:



CAUTION: Carefully follow the host computer's instructions to unmount the microSD card and disconnect USB devices correctly to avoid losing information.

1. On the host computer, unmount the device.
2. Remove the USB cable from the device or remove the device from the cradle.

Applications

This section describes the applications installed on the device.

Battery Manager

The **Battery Manager** provides detailed information about the battery.

To open Battery Manager, swipe up from the bottom of the Home screen and touch .

Figure 56 Battery Manager Screen

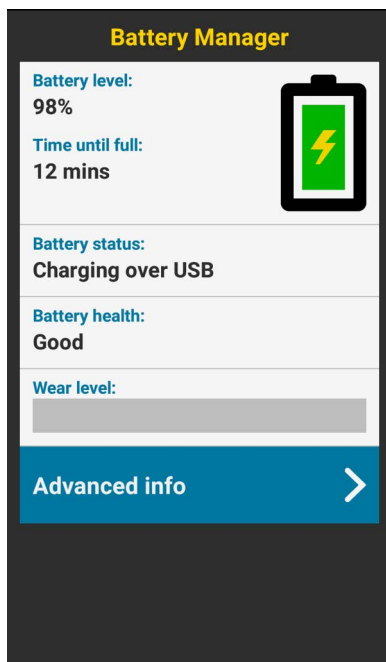





Table 8 Battery Icon Description

Battery Icon	Description
	Battery charge level.
	Battery charging.
	Battery charge level is below 20%.

- **Battery level** - The current battery charge level as a percentage. Displays **-%** when level is unknown.
- **Time until full** - The amount of time until the battery is fully charged.
- **Time since charging** - The amount of time since the device began charging.
- **Time until empty** - The amount of time until the battery is empty.
- **Battery status**
 - **Not charging** - The device is not charging.
 - **Charging over AC** - The device is connected to AC power and charging.
 - **Charging over USB** - The device is connected to a host computer with a USB cable and charging.
 - **Discharging** - That the battery is discharging.
 - **Full** - That the battery is fully charged.
 - **Unknown** - The battery status is unknown.
- **Battery health** - The health of the battery. If a critical error occurs,  appears. Touch to view the error description.
 - **Decommission** - The battery is past its useful life and should be replaced. See system administrator.
 - **Good** - The battery is good.
 - **Charge error** - An error occurred while charging. See system administrator.
 - **Over Current** - An over-current condition occurred. See system administrator.
 - **Dead** - The battery has no charge. Replace the battery.
 - **Over Voltage** - An over-voltage condition occurred. See system administrator.
 - **Below Temperature** - The battery temperature is below the operating temperature. See system administrator.
 - **Failure Detected** - A failure has been detected in the battery. See system administrator.
 - **Unknown** - See system administrator.
- **Wear level** - The health of the battery in graphical form. When the wear level exceeds 80%, the bar color changes to red.

- **Advanced info** - Touch to view additional battery information.
 - **Battery present status** - Indicates that the battery is present.
 - **Battery level** - The battery charge level as a percentage of scale.
 - **Battery scale** - The battery scale level used to determine battery level (100).
 - **Battery voltage** - The current battery voltage in millivolts.
 - **Battery temperature** - The current battery temperature in degrees Centigrade.
 - **Battery technology** - The type of battery.
 - **Battery current** - The average current into or out of the battery over the last second in mAh.
 - **Battery manufacture date** - The date of manufacture.
 - **Battery serial number** - The battery serial number. The number matches the serial number printed on the battery label.
 - **Battery part number** - The battery part number.
 - **Battery rated capacity** - Lists the rated capacity of the backup battery in mAh.
 - **Battery decommission status** - Indicates if the battery is past its life span.
 - **Battery Good** - The battery is in good health.
 - **Decommissioned Battery** - The battery is past its useful life and should be replaced.
 - **Base cumulative charge** - Cumulative charge using Zebra charging equipment only.
 - **Battery usage number** - The health of the battery as a result of charging and discharging. A high number indicates low battery health.
 - **Usage decommission threshold** - When the Battery usage number is greater than or equal to the Usage decommission threshold, the battery is past its useful life and should be replaced.
- **App version** - The application version number.

Camera

This section provides information for taking photos and recording videos using the integrated digital cameras.



The device saves photos and videos on the microSD card, if installed and the storage path is changed manually. By default, or if a microSD card is not installed, the device saves photos and videos on the internal storage.

Taking Photos





NOTE: See Photo Settings for camera setting descriptions.

1. Swipe up from the bottom of the Home screen and touch **Camera**.

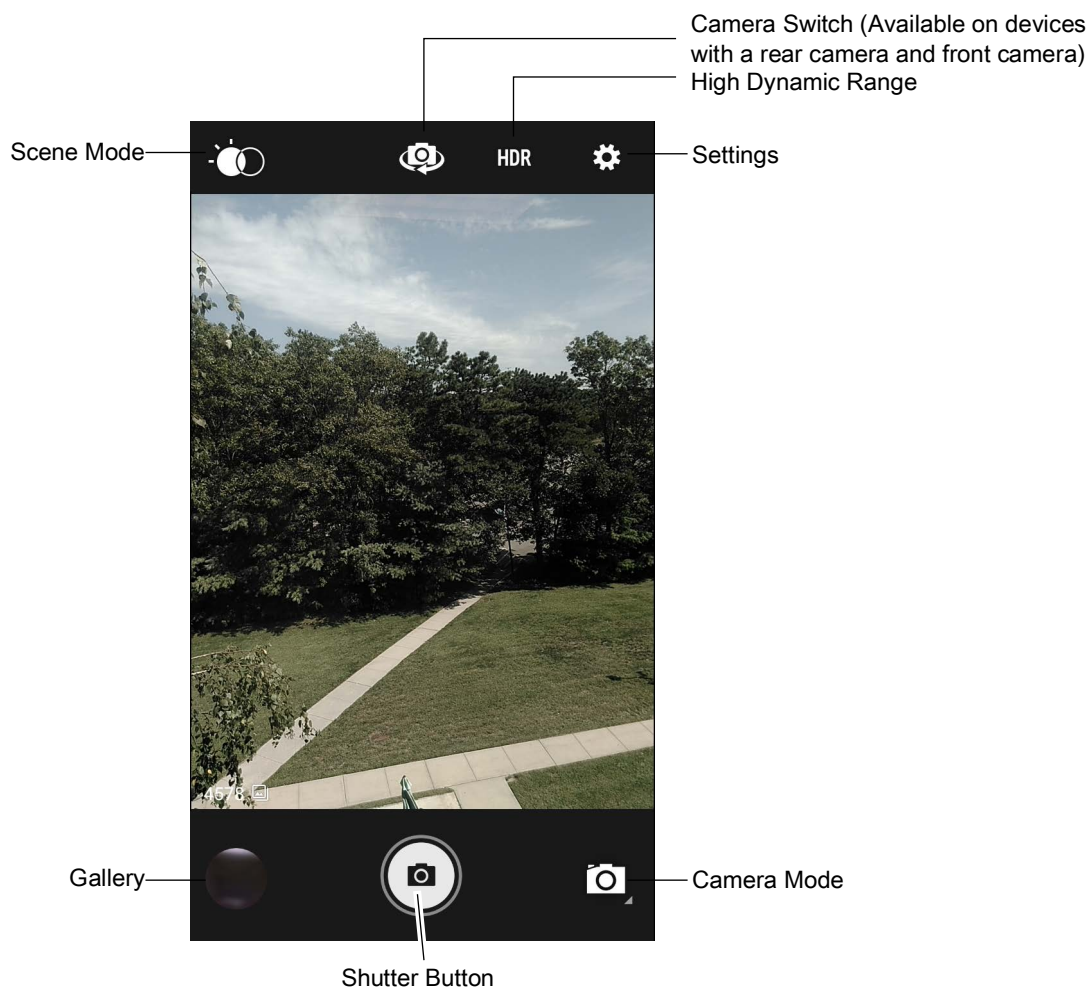
Figure 57 Camera Mode



2. If necessary, touch the Camera Mode icon and touch .
3. To switch between the rear camera and front camera (if available), touch .
4. Frame the subject on the screen.
5. To zoom in or out, press two fingers on the display and pinch or expand fingers. The zoom controls appear on the screen.

6. Touch an area on the screen to focus. The focus circle appears. The two bars turn green when in focus.
7. Touch .
 - The camera takes a photo and a shutter sound plays.
 - The photo momentarily displays as a thumbnail in the lower left corner.



Taking a Panoramic Photo

Panorama mode creates a single wide image by panning slowly across a scene.

1. Swipe up from the bottom of the Home screen and touch **Camera**.

Figure 58 Panoramic Mode



2. Touch the Camera Mode icon and touch .
3. Frame one side of the scene to capture.
4. Touch  and slowly pan across the area to capture. A small white square appears inside the button indicating the capture is in progress.
 - If you are panning too quickly, the message **Too fast** appears.
5. Touch  to end the shot. The panorama appears immediately and a progress indicator displays while it saves the image.

Recording Videos

1. Swipe up from the bottom of the Home screen and touch **Camera**.

2. Touch the camera mode menu and touch .

Figure 59 Video Mode

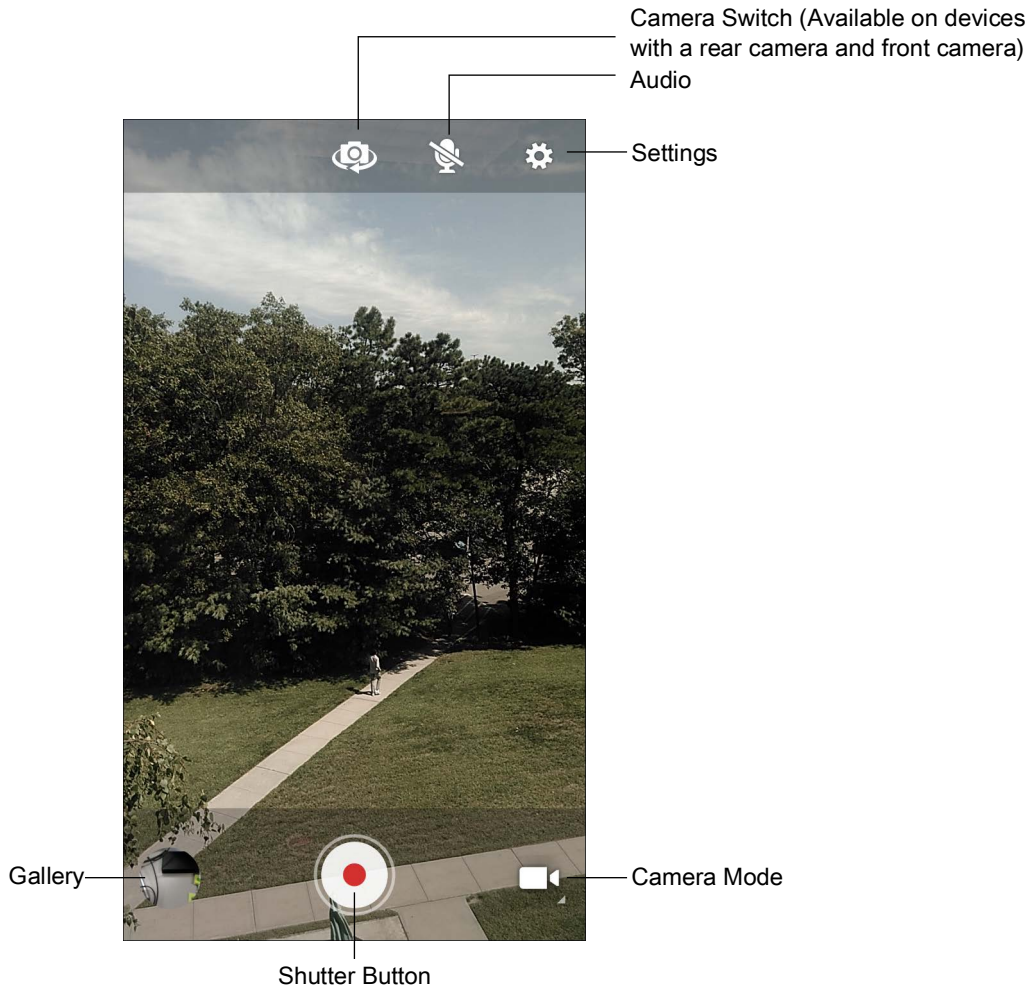













3. To switch between the rear camera and front camera (if available), touch .
4. Point the camera and frame the scene.
5. To zoom in or out, press two fingers on the display and pinch or expand fingers. The zoom controls appear on the screen.
6. Touch  to start recording.
The video time remaining appears in the top left of the screen.
7. Touch  to the end recording.
The video momentarily displays as a thumbnail in the lower left corner.

Photo Settings

In Photo mode, photo settings appear on screen. Touch  to display the photo settings options.

Rear Camera

- **Flash** - Select whether the camera relies on its light meter to decide whether a flash is necessary, or to turn it on or off for all shots.
 -  **Off** - Disable flash.
 -  **Auto** - Adjust flash automatically depending upon light meter (default).
 -  **On** - Enable flash upon taking a photo.
 -  **Torch** - Turn flash on continuously.
- **GPS location** - Turn On or Off (default).
- **Picture size** - The size (in pixels) of the photo to: **13M pixels** (default), **8M pixels**, **5M pixels**, **3M pixels**, **HD 1080**, **2M pixels**, **1.3M pixels**, **HD720**, **1M pixels**, **WVGA**, **VGA**, or **QVGA**.
- **Picture quality** - Set the picture quality setting to: **Low**, **Standard** (default) or **High**.
- **Countdown timer** - Select **Off** (default), **2 seconds**, **5 seconds** or **10 seconds**.
- **Storage** – Set the location to store the photo to: **Phone** or **SD Card**.
- **Face Detection** - Select to turn face detection **Off** (default) or **On**.
- **ISO** - Set camera sensitivity to light to: **Auto** (default), **ISO Auto (HJR)**, **ISO100**, **ISO200**, **ISO400**, **ISO800** or **ISO1600**.
- **Exposure** - Set the exposure settings to: **+2**, **+1**, **0**(default), **-1** or **-2**.
- **White balance** - Select how the camera adjusts colors in different kinds of light, to achieve the most natural-looking colors:
 -  **Incandescent** - Adjust the white balance for incandescent lighting.
 -  **Fluorescent** - Adjust the white balance for florescent lighting.
 -  **Auto** - Adjust the white balance automatically (default).
 -  **Daylight** - Adjust the white balance for daylight.
 -  **Cloudy** - Adjust the white balance for a cloudy environment.
- **Focus mode** - Set the camera focus to **CAF** (Continuous Auto Focus).
- **ZSL** - Set the camera to immediately take a picture when the button is pressed (default – enabled).







Front Camera

- **GPS location** - Add GPS location information to the photo meta-data. Options: **On** or **Off** (default).
- **Picture size** - Set the size (in pixels) of the photo to: **1.3M pixels** (default), **HD720**, **1M pixels**, **WVGA**, **VGA**, or **QVGA**.
- **Picture quality** - Set picture quality setting to: **Low**, **Standard** (default) or **High**.
- **Countdown timer** - Set to: **Off** (default), **2 seconds**, **5 seconds** or **10 seconds**.
- **Storage** – Set location to store the photo to: **Phone** or **SD Card**.
- **Face Detection** - Select to turn face detection **Off** (default) or **On**.

Video Settings

In Video mode, video settings appear on screen. Touch  to display the video settings options.

Rear Camera

- **Flash** - Select whether Rear-facing Camera relies on its light meter to decide whether a flash is necessary, or to turn it on or off for all shots.
 -  **Off** - Disable flash (default).
 -  **Torch** - Turn flash on continuously.
- **Video quality** - Set video quality to: **HD 1080p** (default), **HD 720p**, **SD 480p**.
- **Video duration** - Set to: **30 seconds (MMS)**, or **30 minutes** (default).
- **GPS location** - Turn On or Off (default).
- **Storage** – Set the location to store the photo to: **Phone** (default) or **SD Card**.
- **White balance** - Select how the camera adjusts colors in different kinds of light, to achieve the most natural-looking colors.
 -  **Incandescent** - Adjust the white balance for incandescent lighting.
 -  **Fluorescent** - Adjust the white balance for florescent lighting.
 -  **Auto** - Adjust the white balance automatically (default).
 -  **Daylight** - Adjust the white balance for daylight.
 -  **Cloudy** - Adjust the white balance for a cloudy environment.

Front Camera

- **Video quality** - Set video quality to: **HD 720p** (default), or **SD 480p**.
- **Video duration** - Set to: **30 seconds (MMS)** or **30 minutes** (default).
- **GPS location** - Turn **On** or **Off** (default).
- **Storage** – Set the location to store the photo to: **Phone** (default) or **SD Card**.

Contacts

Use the **Contacts** app to manage contacts.

From a Home or Apps screen, touch **Contacts** to open to the main list of contacts. Contacts are listed in alphabetical order. Swipe up or down to scroll through the list.

Adding a Contact

1. In the **Contacts** app, touch .
2. If there is more than one account with contacts, touch the one you want to use.
3. Type the contact's name and other information. Touch a field to start typing, and swipe down to view all categories.
4. To open a menu with preset labels, such as Home or Work for an email address, touch the label to the right of the item of contact information. Or, to create your own label, touch **Custom** in the menu.
5. Touch the check mark next to **Add New Contact**.

Editing Contacts

1. In the **Contacts** app, touch a contact name to edit.
2. Touch .
3. Edit the contact information.
4. Touch **SAVE**.

Deleting Contacts

1. In the **Contacts** app, touch a contact name to delete.
2. Touch .
3. Touch **Delete**.
4. Touch **DELETE** to confirm.

DataWedge Demonstration



NOTE: DataWedge is enabled on the Home screen. To disable this feature, go to the DataWedge settings and disable the **Launcher** profile.

Use **DataWedge Demonstration** to demonstrate data capture functionality.

Figure 60 DataWedge Demonstration Window

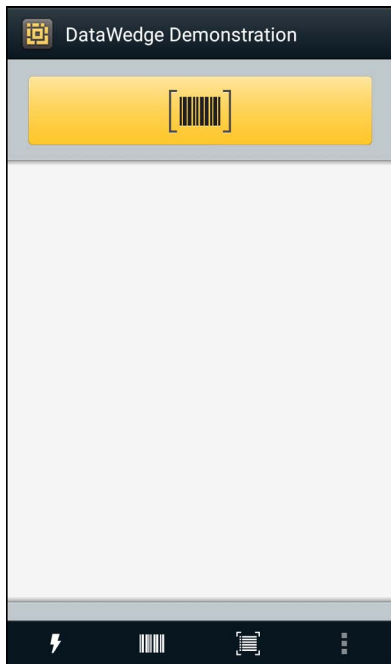











Table 9 DataWedge Demonstration Icons

	Icon	Description
Illumination		Imager illumination is on. Touch to turn illumination off.
		Imager illumination is off. Touch to turn illumination on.
Data Capture		The data capture function is through the internal imager.
		An RS507 or RS6000 Bluetooth imager is connected.
		An RS507 or RS6000 Bluetooth imager is not connected.
Scan Mode		Imager is in picklist mode. Touch to change to normal scan mode.
		Imager is in normal scan mode. Touch to change to picklist mode.
		Opens a menu to view the application information or to set the application DataWedge profile.



NOTE: See the device Integrator Guide for Android Version 8.1 for information on DataWedge configuration.

Scanner Selection

To select a scanner, touch  > **Settings** > **Scanner selection**.

See Data Capture for more information.

Either press the programmable button or touch the yellow scan button to capture data. The data appears in the text field below the yellow button.

Device Central

Device Central displays detailed information about the device and connected peripherals and supports the following Zebra devices:

- RS507/RS507X Hands-free Imager
- RS6000 Bluetooth Ring Scanner
- RS5000 Corded Ring Scanner
- HS3100 Bluetooth Headset
- DS3678 Digital Scanner.

Device Central features include:

- Discovering and pairing with supported peripherals via Bluetooth or corded connection.
- Paging a connected RS6000 Ring Scanner.
- Updating the firmware of supported ring scanners. Refer to the RS5000 Quick Start Guide or RS6000 User Guide for more information.
- Displaying the connection status of peripherals.
- Displaying information for a connected peripheral in the notification bar.

Figure 61 Device Central Screen

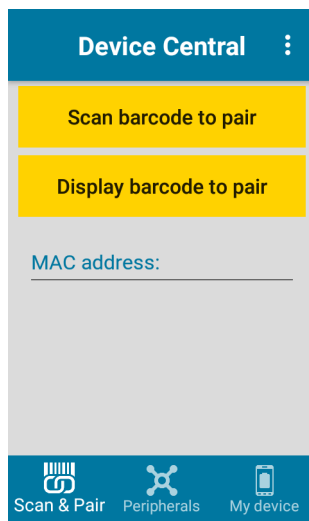

Device Central Tabs

- **Peripherals** Tab - displays all currently connected and previously connected peripherals. Connected peripherals display the length of time (in minutes) that they have been connected. When an RS6000 is connected the **Page** button displays. See Paging an RS6000 Ring Scanner.

Touch the peripheral information to display the **Device Details** screen.

- **Device Details** - displays detailed device information for the selected peripheral.
- **My Device** Tab - displays information about the device and the current version of Device Central.
 - **Device Details** - displays the **Phone status** screen.
 - **Device Battery Details** - displays the **Battery** screen.

Figure 62 Peripherals Tab

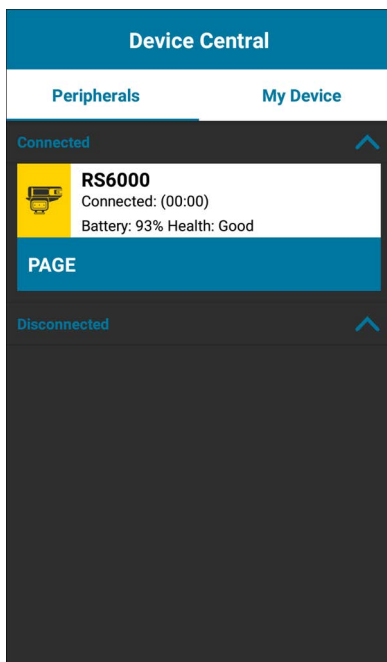

Paging an RS6000 Ring Scanner

Use **Page** button to easily locate the currently connected RS6000 Ring Scanner:

1. With the RS6000 Ring Scanner connected, swipe up from the bottom of the Home screen, and touch .



NOTE: The RS6000 Ring Scanner must be within 10 m (32 ft) of the device.

2. Touch RS6000. The Device Details screen displays.

- Under the RS6000 peripheral information, touch **Page** to page the RS6000. The paged RS6000 beeps and vibrates.

Figure 63 Page RS6000

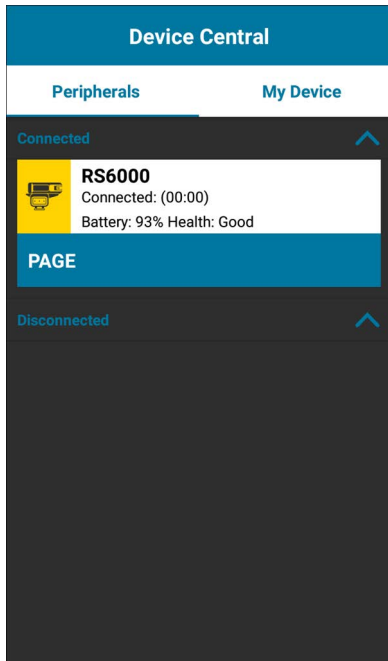

To stop paging, press the scan trigger of the RS6000. On a triggerless RS6000, reset the RS6000 to stop paging. Refer to the RS6000 User Guide.

Diagnostic Tool

The **Diagnostic Tool** is a utility that determines the health of the device. Use the Diagnostic Tool to troubleshoot the device.

- Swipe up from the bottom of the Home screen and touch .

Figure 64 Diagnostic Tool



2. Touch **RUN TEST**. The app tests all enabled subsystems (by default, only the Battery and System tests). See Settings to enable subsystem tests.

Figure 65 Test Passed Screen

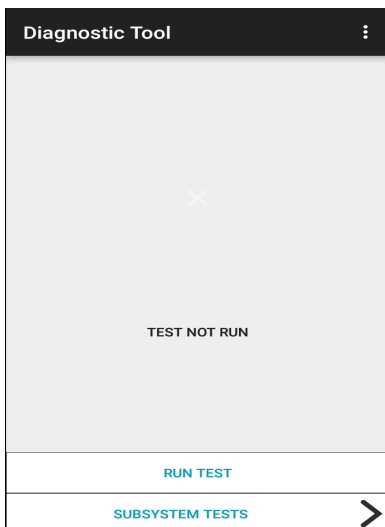
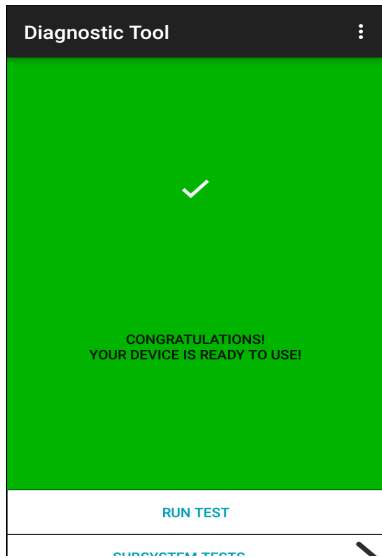
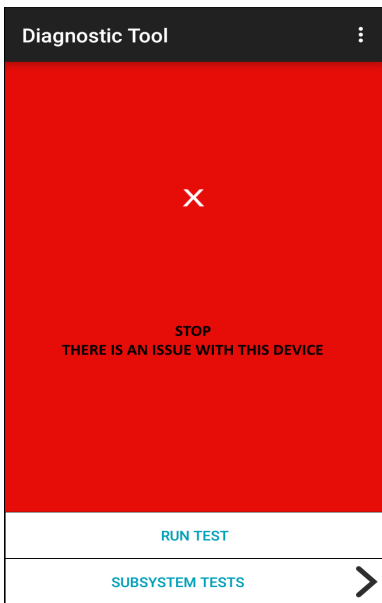
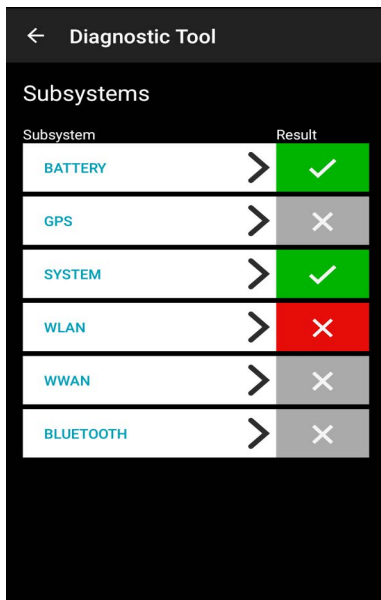

Figure 66 Test Failed Screen



3. To view each subsystem test, touch **Subsystem Tests**.

Figure 67 Subsystem Screen



4. Touch one of the subsystems to view details.

Table 10 Subsystem Test Result Indicators





Status Icon	Description
	Test passed.
	Test failed.
	Test not supported or not enabled.

Figure 68 Battery Subsystem Details

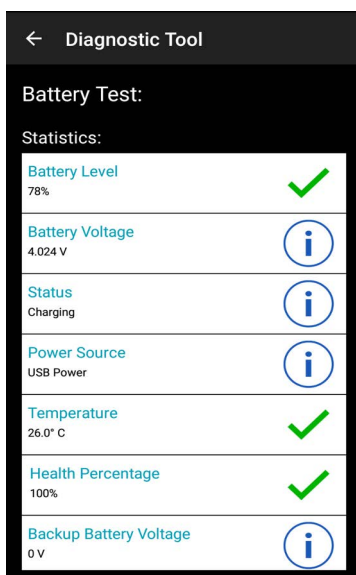

Settings

By default only the Battery and System tests are enabled. To enable other tests:

1. Touch  > **Settings**.
2. Touch to the left of the test name. A green box with a checkmark appears.
3. Touch **SAVE**.
4. Touch **Yes** to confirm.
5. Touch .

Battery Test Information

The Battery Test obtains the following information:

- **Battery Level** - Current battery charge level
- **Battery Voltage** - Current battery voltage
- **Status** - Whether the battery is charging (on AC power) or discharging (on battery power)
- **Power Source** - Whether the device is receiving power from the battery or from an external source
- **Temperature** - Current battery temperature
- **Health Percentage** - Indicates the ratio of present capacity to design capacity at a discharge rate of design capacity.
- **Backup Battery Voltage** - Backup battery voltage.
- **Manufacture Date** - Manufacture date of the battery.

GPS Test Information

The GPS Test obtains the following information (WWAN only):

- **GPS Provider Enabled** - Whether GPS is enabled (true) or disabled (false)
- **Latitude** - Current latitude position
- **Longitude** - Current longitude position
- **Altitude** - Current altitude in meters
- **Bearing** - Current bearing
- **Speed** - Speed in meters per second
- **Accuracy** - GPS accuracy in meters.

Not supported on this device.

System Test Information

Use the System Test to determine if the CPU or memory loads are too high, there are too many processes running on the device, or storage on the device is almost full.

The System Test obtains the following information:

- **CPU Load** - Amount of CPU being used

- **Free Physical Memory** - Amount of RAM available
- **Free Storage** - Amount of internal Flash memory available
- **Process Count** - Number of processes currently running.

WLAN Test Information

If the WiFi radio is not present or disabled, skip this test. This test determines if the device's WLAN configuration is correct or whether there is any connection with an access point or network.

The WLAN test obtains the following information:

- **WLAN Enabled** - WLAN radio is enabled or disabled
- **WLAN Status** - Current status of association with the access point
- **ESSID** - Name of the wireless network
- **BSSID** - MAC address of the connected access point
- **MAC Address** - Device's MAC address
- **Signal** - Strength of the Wi-Fi signal (in dBm)
- **IP Address** - IP address of the device.

WWAN Test Information

The WWAN Test obtains the following information (WWAN only):

- **SIM State** - Current state of the SIM card
- **WAN Type** - Data connection type
- **Signal Strength** - Current cellular signal strength
- **Phone Number** - Phone number assigned to the device
- **Device ID** - Device ID number.

Not supported on this device.

Bluetooth Test Information

The Bluetooth Test obtains the following information:

- **Enabled** - Whether the Bluetooth radio is enabled or disabled
- **Status** - Whether the device is paired to another Bluetooth device
- **Connectable/Discoverable** - Whether the device is discoverable or able to connect
- **Address** - Bluetooth radio MAC address
- **Name** - Bluetooth name for the device.

Files

Use the **Files** app to view and manage files on the device.







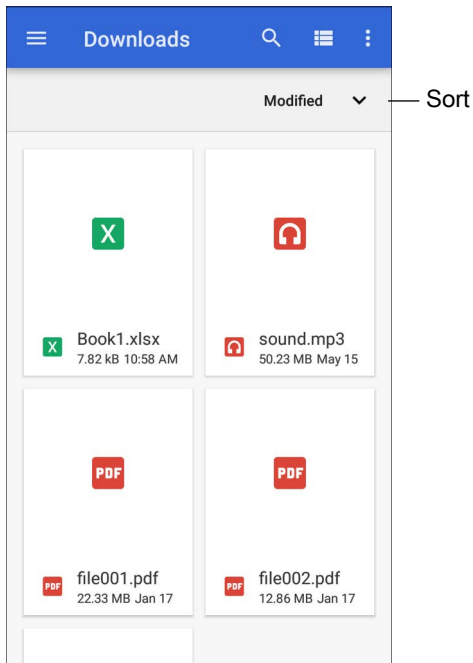

To open **Files**, swipe up from the bottom of the screen and touch .

Figure 69 Files Screen



- Touch and hold an item to open the File Operations menu. Select an option:
 -  - Share the file with other devices.
 -  - Delete the file.
 -  - View additional options.
 - **Open with** - Select which app is used to open the file.
 - **Select all** - Select all folders and files.
 - **Copy to...** - Copy the file.
 - **Move to...** - Move the file or folder to a new location.
 - **Compress** - Compress the selected file(s) into a ZIP file.
 - **Rename** - Rename the file.
- Touch the Sort drop-down to sort files by name, type, size, or date.
-  - View all file locations.
-  - Search for a specific file on the device.
-  /  - Change the folder to display items as a list / grid.
-  - Open the options menu.
 - **New Window** - Create a new Files window.
 - **New Folder** - Create a new folder.
 - **Select all** - Select all folders and files.
 - **Show/Hide internal storage** - Show or hide internal storage.

Gallery



NOTE: The device supports the following image formats: jpeg, gif, png and bmp.

The device supports the following video formats: H.263, H.264 and MPEG4 Simple Profile.

Available on device with AOSP only.

Use Gallery to:

- View photos
- Play videos
- Perform basic editing of photos
- Set photos as wallpaper
- Set photos as a contact photo
- Share photos and videos.

Gallery presents all photos and videos stored on the microSD card and internal memory.

To open **Gallery**, swipe up from the bottom of the Home screen and touch **Gallery**, or in the camera app touch the thumbnail image at the bottom left.

By default, **Gallery** opens to the **Timeline** view.

Figure 70 Gallery - Timeline View

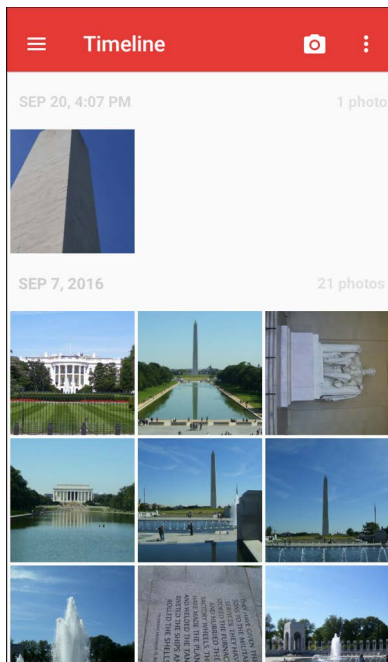





Touch  > **Albums** to view photos sorted by albums or  > **Videos** to view only videos.

Figure 71 Gallery — Albums View

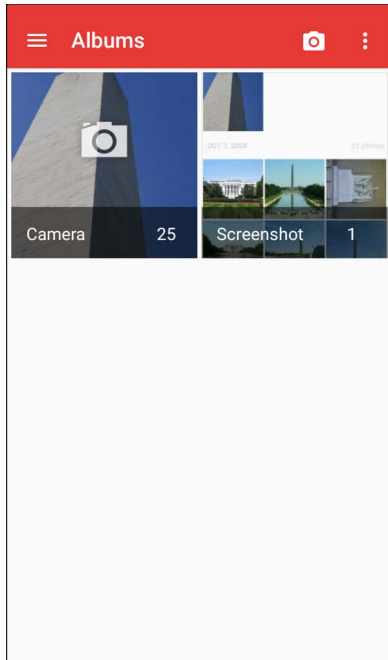

- Touch an album to open it and view its contents. The photos and videos in the album are displayed in chronological order.
- Touch a photo or video in an album to view it.
- Touch  > **Timeline** to return to the default **Gallery** screen.

Working with Albums

Albums are groups of images and videos in folders. Touch an album to open it. The photos and videos are listed in a chronologically ordered grid. The name of the album displays at the top of the screen.

Figure 72 Photos Inside an Album

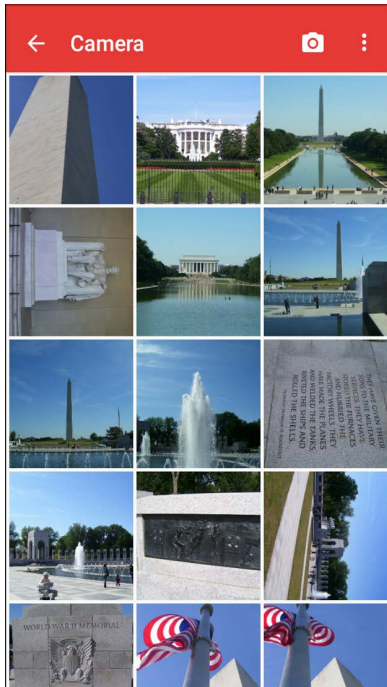

Swipe up or down to scroll through the images.

Sharing an Album

1. Swipe up from the bottom of the Home screen and touch **Gallery**.
2. Touch and hold an album to highlight it.
3. Touch other albums as required.
4. Touch . The Share menu opens.
5. Touch the app to use to share the selected albums.
6. Follow the instructions within the selected app.

Getting Album Information

1. Swipe up from the bottom of the Home screen and touch **Gallery**.
2. Touch and hold an album to highlight it.
3. Touch .
4. Touch **Details**.

Deleting an Album

To delete an album and its contents:

1. Swipe up from the bottom of the Home screen and touch **Gallery**.
2. Touch and hold an album to highlight it.
3. Check other albums to delete.
4. Touch .
5. In the **Delete selected item?** menu, touch **OK** to delete the album.

Working with Photos

Use **Gallery** to view photos on the device and edit and share photos.

Viewing and Browsing Photos

To view a photo:

1. Swipe up from the bottom of the Home screen and touch **Gallery**.
2. Touch an album to open it.
3. Touch a photo.

Figure 73 Photo Example

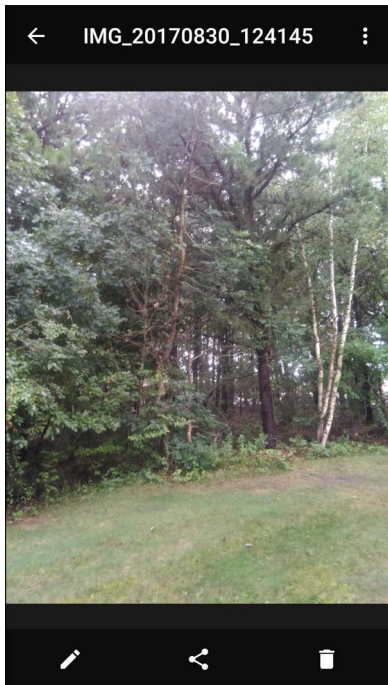

4. Swipe left or right to view the next or previous photo in the album.
5. Turn the device to view the photo in upright (portrait) or sideways (landscape) orientation. The photo is displayed (but not saved) in the new orientation.
6. Touch the photo to view the controls.

7. Double-tap the screen to zoom in or pinch two fingers together or spread them apart to zoom in or out.
8. Drag the photo to view parts that are not in view.

Cropping a Photo





1. In **Gallery**, touch a photo to view the controls.
2. Touch  >  > . The cropping tool appears.
3. Use the cropping tool to select the portion of the photo to crop.
 - Drag from the inside of the cropping tool to move it.
 - Drag an edge of the cropping tool to resize it to any proportion.

Figure 74 Cropping Tool



4. Touch  > **SAVE** to save a copy of the cropped photo. The original version is retained.

Setting a Photo as a Contact Icon

1. Swipe up from the bottom of the Home screen and touch **Gallery**.
2. Touch an album to open it.
3. Touch a photo to open it.
4. Touch .
5. Touch **Set picture as**.
6. Touch **Contact photo**.
7. In **Contacts**, touch a contact.
8. Touch the white box and crop the photo accordingly.

9. Touch **SAVE**.

Sharing a Photo

1. Swipe up from the bottom of the Home screen and touch **Gallery**.
2. Touch an album to open it.
3. Touch a photo to open it.
4. Touch .
5. Touch the app to use to share the selected photo.
6. Follow the instructions within the selected app.

Deleting a Photo

1. Swipe up from the bottom of the Home screen and touch **Gallery**.
2. Touch an album to open it.
3. Touch a photo to open it.
4. Touch .
5. Touch **OK** to delete the photo.

Working with Videos

Use **Gallery** to view and share videos.

Watching Videos

1. Swipe up from the bottom of the Home screen and touch **Gallery**.
2. Touch an album to open it.
3. Touch a video.
4. Touch  to play.
5. Touch the screen to view the playback controls.

Sharing a Video

1. Swipe up from the bottom of the Home screen and touch **Gallery**.
2. Touch an album to open it.
3. Touch a video to open it.
4. Touch . The Share menu appears.
5. Touch the app to use to share the selected video.
6. Follow the instructions within the selected app.

Deleting a Video

1. Swipe up from the bottom of the Home screen and touch **Gallery**.
2. Touch an album to open it.
3. Touch a video to open it.
4. Touch .
5. Touch **OK**.

Messaging



NOTE: WWAN Only.

Use Messaging to send and receive SMS and MMS messages.

To open **Messaging**, swipe up from the bottom of the screen and touch Messaging.

Sending a Text Message

1. In the main Messaging screen, touch .

Figure 75 New Text Message Screen

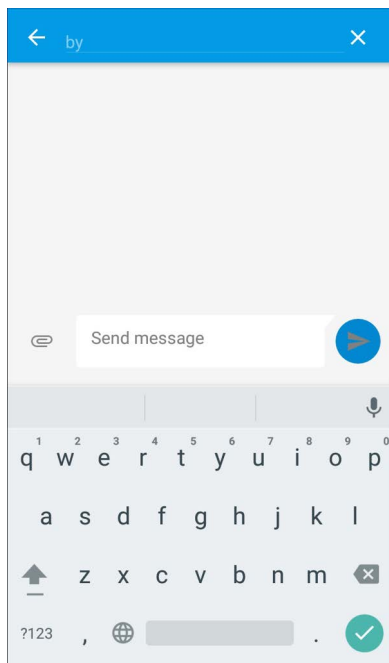

2. In the **To** field, enter a name or a mobile phone number.
3. In the **Send message** field, enter the text message.

The 160-character limit counter indicates how many characters are left. If it exceeds the limit, a new message is created, which is joined with its predecessors when received.

Press the Back button while composing a message to save it as a draft in the Messaging screen. Touch the conversation to resume composing it.

4. Touch  to send message.

Sending a Multimedia Message





1. In the main Messaging screen, touch .
2. In the **To** field, enter a name or a mobile phone number.
3. Touch  to attach the media file of your choice.

Figure 76 New Multimedia Message Screen

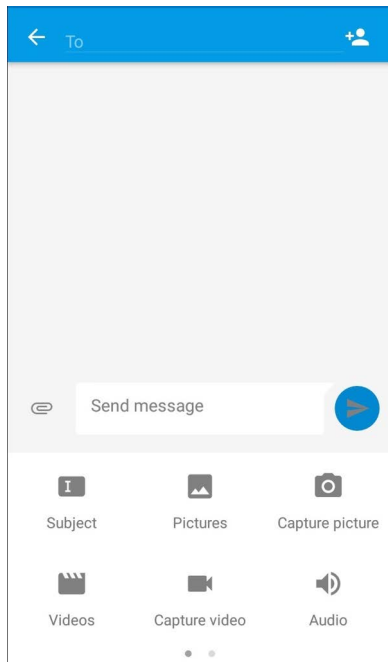

- **Subject** - Enter a message subject.
 - **Pictures** - Select a picture to attach.
 - **Capture picture** - Open the Camera to take a picture and attach it.
 - **Videos** - Select a video to attach.
 - **Capture video** - Open the Camcorder to record a video and attach it to the message.
 - **Audio** - Choose a sound file to attach.
 - **Record audio** - Open the Sound Recorder to record a spoken message and attach it to the message.
 - **Slideshow** - Open a screen opens to assemble text, photos, videos, and recordings into a slideshow of up to 10 slides to attach to the message.
 - **Insert contact info** - Open the Contacts app and select one or more contacts to insert the contact information into the message.
 - **Contact vCard** - Send a contact's information.
 - **Import Template** - Import a message template.
4. Touch  to send the message.

Photos



NOTE: The device supports the following image formats: jpeg, gif, png, and bmp.
The device supports the following video formats: H.263, H.264, and MPEG4 Simple Profile.
Available on device with GMS only.

Use **Photos** to:

- View photos
- Play videos
- Perform basic editing of photos
- Set photos as wallpaper
- Set photos as a contact photo
- Share photos and videos.

Photos presents all photos and videos stored on the microSD card and internal memory.

To open **Photos**, swipe up from the bottom of the Home screen and touch **Photos**.

By default, **Photos** opens to the photos view.

Figure 77 Photos View

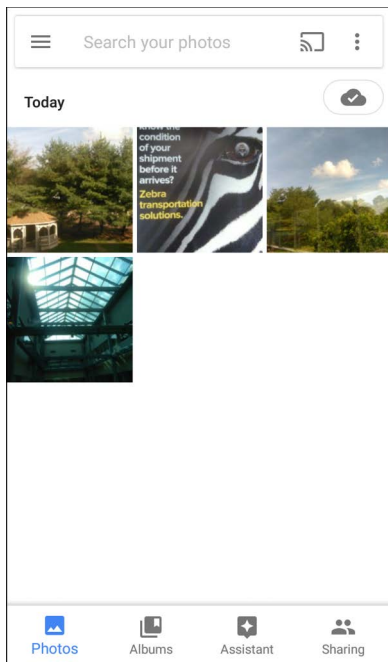

Touch **Albums** to view photos sorted by albums.

Figure 78 Albums View

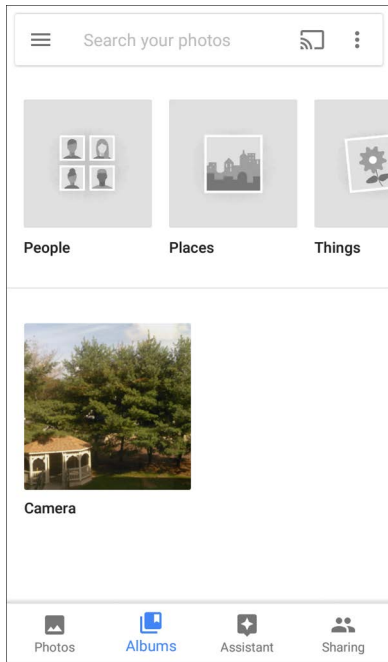

- Touch an album to view its contents. The photos and videos in the album appear in chronological order.
- Touch a photo or video in an album to view it.
- Touch ← to return to the main screen.

Working with Photos

Use **Photos** to view photos on the internal memory and the microSD card.

Viewing and Browsing Photos

1. Swipe up from the bottom of the Home screen and touch **Photos**.

2. Touch a photo.

Figure 79 Photo Example

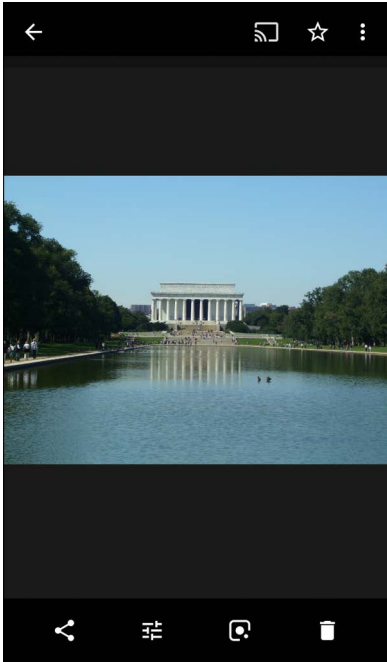

3. Swipe left or right to view the next or previous photo in the album.
4. Turn the device to view the photo in upright (portrait) or sideways (landscape) orientation. The photo is displayed (but not saved) in the new orientation.
5. Touch the photo to view the controls.
6. Double-tap the screen to zoom in, or pinch two fingers together or spread them apart to zoom in or out.
7. Drag the photo to view parts that are not in view.

Cropping a Photo

1. Swipe up from the bottom of the Home screen and touch **Photos**.
2. Touch a photo to view the controls.



3. Touch  > . The cropping tool appears.

Figure 80 Cropping Tool



4. Use the cropping tool to select the portion of the photo to crop.
 - Drag from the inside of the cropping area to move it.
 - Drag an edge of the cropping area to resize it to any proportion.
5. Touch **DONE**.
6. Touch **SAVE** to save a copy of the cropped photo. The original version is retained.

Setting a Photo as a Contact Icon

1. Swipe up from the bottom of the Home screen and touch **Photos**.
2. Touch the photo to open it.
3. Touch  > **Use as**.
4. Touch **Contact photo**.
5. In the **Contacts** app, touch a contact.
6. Touch the white box and crop the photo accordingly.
7. Touch **Done**.

Sharing a Photo

1. Swipe up from the bottom of the Home screen and touch **Photos**.
2. Touch an album to open it.
3. Touch a photo to open it.

4. Touch .
5. Touch the app to use to share the selected photo.
6. Follow the instructions within the selected app.

Deleting a Photo

1. Swipe up from the bottom of the Home screen and touch **Photos**.
2. Touch a photo to open it.
3. Touch .
4. Touch **MOVE TO TRASH**.

Working with Albums

Albums are groups of images and videos in folders. Touch an album to open it. The photos and videos are listed in a chronologically ordered grid. The name of the album displays at the top of the screen.

Figure 81 Photos Inside an Album

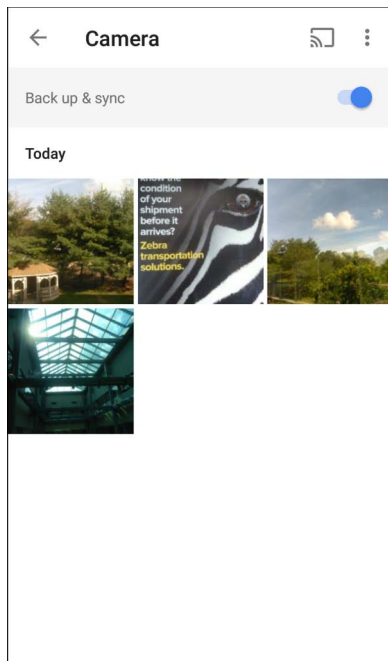

Swipe up to scroll through the images.



Sharing an Album

1. Swipe up from the bottom of the Home screen and touch **Photos**.
2. Touch **Albums**.
3. Touch an album.
4. Touch  > **Select**.

5. Select all photos in the album.
6. Touch . The Share menu opens.
7. Touch an app to share the selected albums.
8. Follow the instructions within the selected app.

Deleting an Album

To delete an album and its contents:

1. Swipe up from the bottom of the Home screen and touch **Photos**.
2. Touch **Albums**.
3. Touch an album.
4. Touch  > **Select**.
5. Select all photos in the album.
6. Touch .
7. Touch **Move to trash** to delete the album.

Working with Videos

Use **Photos** to view and share videos.

Watching a Video

1. Swipe up from the bottom of the Home screen and touch **Photos**.
2. Touch a video to play.
3. Touch the screen to view the playback controls.

Sharing a Video

1. Swipe up from the bottom of the Home screen and touch **Photos**.
2. Touch a video to open it.
3. Touch . The Share menu appears.
4. Touch the app to use to share the selected video.
5. Follow the instructions within the selected app.

Deleting a Video

1. Swipe up from the bottom of the Home screen and touch **Photos**.
2. Touch a video to open it.
3. Touch .
4. Touch **MOVE TO TRASH** to delete the video.

PTT Express Voice Client



NOTE: PTT Express Voice Client enables Push-To-Talk (PTT) communication between disparate enterprise devices. Leveraging existing Wireless Local Area Network (WLAN) infrastructure, PTT Express delivers simple PTT communication without requiring a voice communication server.

- **Group Call:** Press and hold the PTT (Talk) button to start communicating with other voice client users.
- **Private Response:** Double-press the PTT button to respond to the originator of the last broadcast or to make a Private Response.

PTT Express User Interface

Figure 82 PTT Express Default User Interface

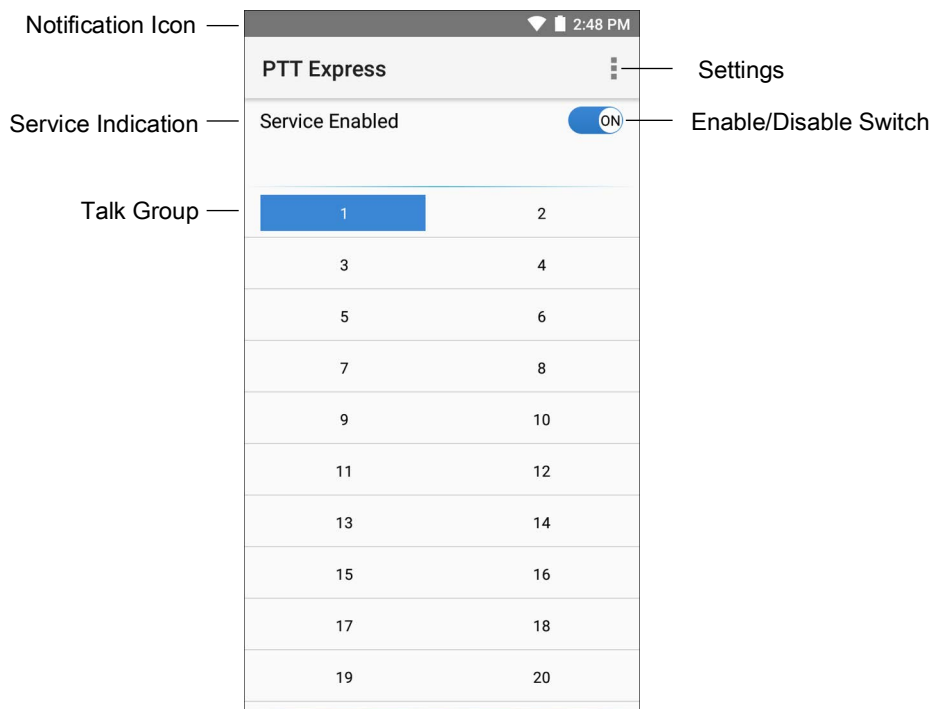

Table 11 PTT Express Default User Interface Descriptions

Item	Description
Notification Icon	Indicates the current state of the PTT Express client.
Service Indication	Indicates the status of the PTT Express client. Options: Service Enabled , Service Disabled or Service Unavailable .
Talk Groups	Lists all 32 Talk Groups available for PTT communication.
Settings	Opens the PTT Express Settings screen.
Enable/Disable Switch	Turns the PTT service on and off.

PTT Audible Indicators







The following tones provide helpful cues when using the voice client.

- **Talk Tone:** Double chirp. Plays when the Talk button is depressed. This is a prompt for you to start talking.
- **Access Tone:** Single beep. Plays when another user just finished a broadcast or response. You can now initiate a Group Broadcast or Private Response.
- **Busy Tone:** Continuous tone. Plays when the Talk button is depressed and another user is already communicating on the same talkgroup. Plays after the maximum allowed talk time is reached (60 seconds).
- **Network Tone:**
 - Three increasing pitch beeps. Plays when PTT Express acquires the WLAN connection and the service is enabled.
 - Three decreasing pitch beeps. Plays when PTT Express loses the WLAN connection or the service is disabled.

PTT Notification Icons

Notification icons indicate the current state of the PTT Express Voice client.

Table 12 PTT Express Icon Descriptions

Status Icon	Description
	The PTT Express Voice client is disabled.
	The PTT Express Voice client is enabled but not connected to a WLAN.
	The PTT Express Voice client is enabled, connected to a WLAN, and listening on the Talk Group indicated by the number next to the icon.
	The PTT Express Voice client is enabled, connected to a WLAN, and communicating on the Talk Group indicated by the number next to the icon.
	The PTT Express Voice client is enabled, connected to a WLAN, and in a private response.
	The PTT Express Voice client is enabled and muted.
	The PTT Express Voice client is enabled but it is not able to communicate due to a VoIP telephony call in progress.

Enabling PTT Communication

1. Swipe up from the bottom of the Home screen and touch .
2. Slide the **Enable/Disable Switch** to the **ON** position. The button changes to **ON**.

Selecting a Talk Group

One of 32 Talk Groups can be selected by PTT Express users. However, only one talk group may be enabled at a time on the device. Touch one of the 32 Talk Groups. The selected Talk Group is highlighted.

PTT Communication



NOTE: This section describes the default PTT Express client configuration. Refer to the PTT Express V1.2 User Guide for detailed information on using the client.

Figure 83 PTT communication may be established as a Group Call. When PTT Express is enabled, the PTT button on the left side of the device is assigned for PTT communication. When the Wired Headset is used, Group Calls can also be initiated using the headset Talk button. PTT Button

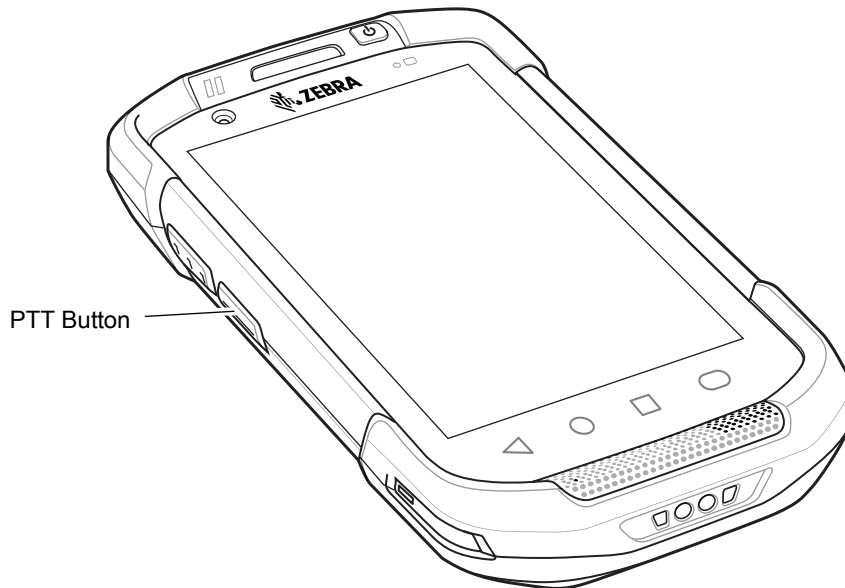

Creating a Group Call

1. Press and hold the PTT button (or the Talk button on the headset) and listen for the talk tone.
If you hear a busy tone, release the button and wait a moment before making another attempt. Ensure that PTT Express and the WLAN are enabled.
2. Start talking after hearing the talk tone.



NOTE: Holding the button for more than 60 seconds (default) drops the call, allowing others to make Group calls. Release the button when finished talking to allow others to make calls.



Responding with a Private Response

The Private Response can only be initiated once a Group Call has been established. The initial Private Response is made to the originator of the Group Call.

1. Wait for an access tone.
2. Within 10 seconds, double-press the PTT button, and listen for the talk tone.

3. If you hear a busy tone, release the button and wait a moment before making another attempt. Ensure that PTT Express and the WLAN are enabled.
4. Start talking after the talk tone plays.
5. Release the button when finished talking.

Disabling PTT Communication

1. Swipe up from the bottom of the Home screen and touch .
2. Slide the **Enable/Disable Switch** to the **OFF** position. The button changes to **OFF**.
3. Touch .

RxLogger

RxLogger is a comprehensive diagnostic tool that provides app and system metrics. Create custom plug-ins that work seamlessly with this tool. RxLogger diagnoses device and application issues, and tracks information for: CPU load, memory load, memory snapshots, battery consumption, power states, wireless logging, cellular logging, TCP dumps, Bluetooth logging, GPS logging, logcat, ANR dumps, etc. All logs and files generated are saved in flash storage on the device (internal or external).

Figure 84 RxLogger

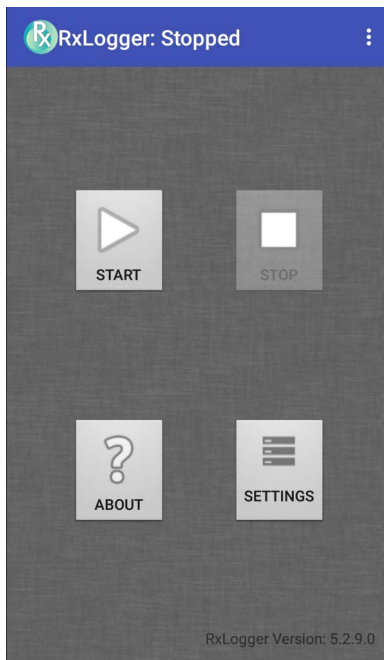

RxLogger Utility

RxLogger Utility is a data monitoring application for viewing logs in the device while RxLogger is running. Access the logs and RxLogger Utility features in the App View or the Overlay View.

In the App View, view logs in the RxLogger Utility.

Figure 85 RxLogger Utility App View



Refer to the device Integrator Guide for detailed information on the RxLogger Utility.

SimulScan Demo

The SimulScan Demo app is an out of the box demonstration app, included on devices that support SimulScan.

The SimulScan Demo app includes the following:

- Postal, Transportation and Logistics Example - Demonstrate the Optical Character Recognition (OCR) and Optical Mark Recognition (OMR) features.
- Manufacturing Example - Demonstrate the MultiCode 20 feature.

- Demo Customization - Create a template using the Template Builder or use a default template. Test templates on the device.

Figure 86 SimulScan Demo Home Screen

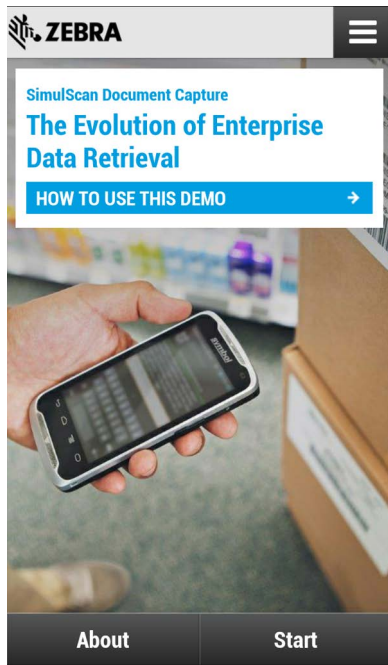

Printing the Sample Forms

In order to perform the Postal, Transportation & Logistics or Manufacturing demonstrations, print the example forms stored on the device.

1. Launch **SimulScan Demo** application.
2. On the **SimulScan Demo** home screen, touch **HOW TO USE THIS DEMO**.
3. Scroll down and touch **Export sample forms** button. The device copies the forms to the `\simulscan\samples` folder in Internal Storage.
4. Connect the device to a computer using the USB Charging cable.
5. Copy the files from the `\simulscan\samples` folder in Internal Storage to the computer.
6. Print the forms.

Using the Postal, Transportation and Logistics Example

7. Print the Postal, Transportation and Logistics form. See Printing the Sample Forms.

Figure 87 Postal, Transportation and Logistics Form

1 Payer account number and insurance details		2 Non-Document Shipments Only (Customs Requirements)	
Charge to <input checked="" type="checkbox"/> Shipper <input type="checkbox"/> Receiver <input type="checkbox"/> 3rd party <small>Not all payment options are available in all countries.</small> Payer Account No. 001-12349876		Attach the original and four copies of a Proforma or Commercial Invoice Shipper's VAT/GST number 564451112 Receiver's VAT/GST or Shipper's EIN/SSN 1111577738 Harmonised Commodity Code if applicable	
Shipment Insurance see reverse <input checked="" type="checkbox"/> Yes Insurance value (in local currency) 1400		Destination duties/taxes If left blank receiver pays duties/taxes <input type="checkbox"/> Receiver <input type="checkbox"/> Shipper <input type="checkbox"/> Other _____ <small>specify approved account number</small>	
3 From (Shipper)		4 To (Receiver)	
Shipper's account number 155-22263 Company name Pure Theory Ltd Address 163B Lansdown Drive Fitzrovia, London England WC2 1AB		Company name TFW Solutions Delivery address <small>We cannot deliver to a PO Box</small> Solvalla Travbaneplan 12A 64 Bromma Postcode/Zip Code (required) 286 32 Country Sweden	
Contact name Scott Andrews Phone, Fax or E-mail (required) 0207 553633		Contact person Aidan Peterson Phone, Fax or E-mail (required) +46 8 123 89 67	
		5 Shipper's agreement <small>(Signature required) Unless otherwise agreed in writing, I/we agree to the Terms and Conditions of Carriage between mo/us and (1) such Terms and Conditions and, where applicable, the Convention limits and/or excludes liability for loss, damage or delay and (2) this shipment does not contain cash or dangerous goods (see reverse).</small>  Signature _____ Date 10 / 10 / 13	

For more information visit our website or call our local office

8. Place the form on a flat surface.

9. On the device, launch **SimulScan Demo** app.

10. Touch the **Menu** icon in the top right corner of the screen.

11. Touch **Postal, Transportation & Logistics**.

12. Touch **Start SimulScan**.

13. Use the image control at the bottom of the screen to control the flash, audio and zoom level.

Figure 88 Image Controls

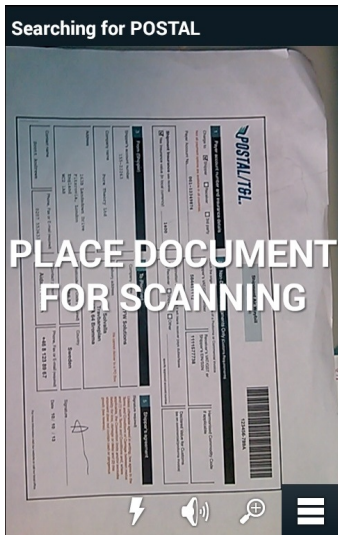

14. Position the camera over the form. Ensure that the complete border of the form is visible on the screen.

15. Hold the device steady.

16. Once the device detects the form **Tap Screen to Scan** appears on the screen.

17. Tap the screen to start the data capture. When completed, the device beeps and the data from the form displays.

Figure 89 Postal Data Screen

POSTAL	
Field	Parsed Data
Barcode	123456-789A
Charge To	<input checked="" type="checkbox"/>
Account Number	155-22253
Shipper Name	<div style="border: 1px solid red; background-color: #ffe6e6; padding: 2px;"> ▲ Check Result Pssupcs Thckry Ltd </div> <div style="background-color: #f0f0f0; padding: 2px;">Pure Theory Ltd</div>
Shipper Address	<div style="border: 1px solid red; background-color: #ffe6e6; padding: 2px;"> ▲ Check Result 1538 Landsdown Drive lill,tgrav;la, ll;pdolrls England WC2 IAB </div> <div style="background-color: #f0f0f0; padding: 2px;">163B Landsdown Drive Fitzrovia, London England WC2 IAB</div>
<div style="display: flex; justify-content: space-between; align-items: center;"> RESCAN ACCEPT ☰ </div>	

18. Touch the text boxes to correct any errors. Note: if there are too many errors, touch **Rescan** to perform the capture again.

19. Touch **Accept** to confirm the data is correct. The **Results summary** screen appears.

20. Touch **OK**.

Using the Manufacturing Example

1. Print the Manufacturing form. See [Printing the Sample Forms](#).

Figure 90 Manufacturing Form

The image shows a screenshot of a mobile application interface for an MSI reader. The interface is titled "MSI reader" and includes a weight indicator "<5 kgs MV unit" in the top right corner. A purple gear icon with an 'M' is in the top left. The form contains the following fields and barcodes:

- PART NUMBER (P):** 5290261-69
- SUPPLIER (V):** V4305156059
- QUANTITY (Q):** 000128
- PKG ID/SERIAL NUMBER (IS):** 1SX1000114
- MADE IN MEXICO:** (indicated by a small barcode)

The Manufacturing Ltd logo is located in the bottom right corner of the form.

2. Place the form on a flat surface.
3. On the device, launch **SimulScan Demo** app.
4. Touch the **Menu** icon in the top right corner of the screen.
5. Touch **Manufacturing**.
6. Touch **Start SimulScan**.
7. Point the top of the device at the document and center the target on the document.
8. Hold the device steady.

- The device starts the data capture. When completed, the device beeps and the data from the document displays.

Figure 91 Manufacturing Data

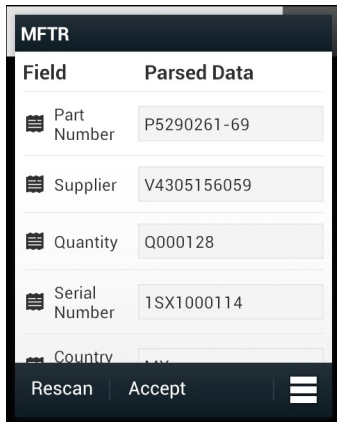

- Touch the text boxes to correct any errors. If there are too many errors, touch **Rescan** to perform the capture again.
- Touch **Accept** to confirm the data is correct. The **Results summary** screen appears.
- Touch **OK**.

Settings

To set the settings for the **SimulScan Demo** application touch **Menu icon** > **Settings**.

Figure 92 Settings Screen

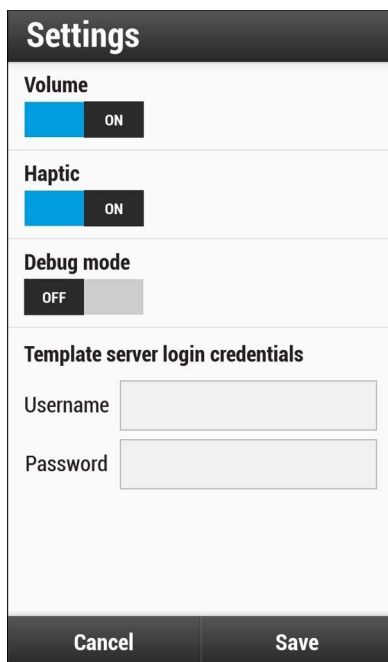

- Volume** - Toggle switch to turn audible notification on and off.
- Haptic** - Toggle switch to turn vibration notification on and off.

- **Debug mode** - Toggle switch to enable or disable debug mode.
- **Template server login credentials** - enter credentials for accessing the template server.

Advanced Settings

Use the Advanced setting to configure data capture options. In the data capture screen, touch  in the bottom right corner of the screen.

Figure 93 Advanced Settings Screen



- **Identification Timeout** - Set the amount of time to wait before timing out identifying the target document. Options: **2 seconds**, **5 seconds**, **10 seconds**, **15 seconds**, **20 seconds** or **25 seconds**.
- **Processing Timeout** - Once the target document is identified, amount of time to wait before timing out processing.
- **Audio Feedback** - Turn on or off audio feedback on successful parse.
- **Haptic Feedback** - Turn on or off haptic (vibration) feedback on successful parse.
- **LED Feedback** - Turn on or off LED feedback on successful parse.
- **Debug Mode** - If enabled, allows a session to write form capture, region images, region values, and other data to storage. Use only when directed by administrator.
- **Auto Capture** - Set to **On** to automatically capture forms when detected. Set to **Off** to manually capture forms when user taps screen or presses a trigger button.
- **Image Correction** - Turn on when document is crumpled or curved and requires advanced image correction.
- **Capture Sensitivity** - Increase sensitivity for increased document identification accuracy before processing.
- **About** - Displays the SimulScan Engine version number.
- **Quit Scanner** - Exit Advanced Settings screen.

Creating a Demo Customization

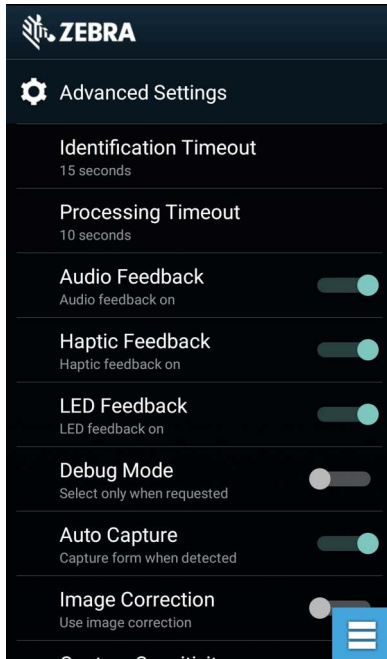
Before creating a customized demo, first:

- Create a template using the Template Builder tool.
 - Copy a company logo and image to the device storage location.
1. Touch **Menu** icon.
 2. Touch **Setup Custom Demo**.

Figure 94 Custom Demo Setup Screen

3. In the **Name** text box, enter a name for the custom demo that appears in the drop-down menu.
4. In the **Custom Demo Setup** text box, enter a title for the demo that appears in the demo screen title box.
5. Touch the **Image** field to select an image from the SD card.
6. Touch the **Logo** field to select the logo image from the SD card.
7. In the **Introduction** text box, enter text that appears on the demo screen.
8. In the **Header color** text box, enter the hex color value for the header.
9. In the **Icon color** text box, enter the hex color value for Menu icon and button text.
10. In the **Key Features** text box, enter text that appears in bullet format under the Key Feature heading.
11. Touch one of the **SimulScan Document Capture Template** fields to select a template
 - a. **Browse external storage** - select a template loaded on the device.
 - b. **Default templates** - select one of the default templates.
 - c. **Select from server** - select a template from the SimulScan server.
12. Touch **Done**. The customized example appears on the screen.
13. Touch **Start SimulScan** to begin the demonstration.

Default Templates

The following templates are available:

- **Default - BankCheck.xml** – Reads the MICR E-13B font (length between 19 and 40 characters) on bank checks.
- **Default - Barcode 1.xml** – Reads a single supported bar code.
- **Default - Barcode 10.xml** – Reads up to 10 supported bar codes.
- **Default - Barcode 2.xml** – Reads two supported bar codes.
- **Default - Barcode 4.xml** – Reads up to supported four bar codes.
- **Default - Barcode 5.xml** – Reads up to supported five bar codes.
- **Default - BookNumber.xml** – Reads the OCR-B ISBN 10 or 13 digit book numbers.
- **Default - DocCap + Optional Barcode** – Captures a full page image and decode any supported bar codes that are in the form. The captured area is the largest rectangular region in the field of view defined by the solid border or contrast of background. Any OCR or OMR content will not be decoded in this mode. The captured area is further processed to correct, de-skew and sharpen and returned as a picture.
- **Default - DocCap + Required Barcode** – Captures a full page image and decode of any supported bar codes that are present in the form. The captured area is the largest rectangular region in the field of view defined by the solid border or contrast of background. Any OCR or OMR content will not be decoded in this mode. The captured area is further processed to correct, de-skew and sharpen and returned as a picture.
- **Default - TravelDoc.xml** – Reads passport and Visa travel documents with OCR-B types A and B fonts.
- **Default - Unstructured Multi-Line** – Reads up to seven lines of text.
- **Default - Unstructured Single Line** – Reads a single line of text.

Sound Recorder

Use **Sound Recorder** to record audio messages.

Recordings are saved on the microSD card (if installed) or the internal storage and are available in the Music application (non-GMS devices) or the Play Music application (GMS devices).

Figure 95 Sound Recorder Application

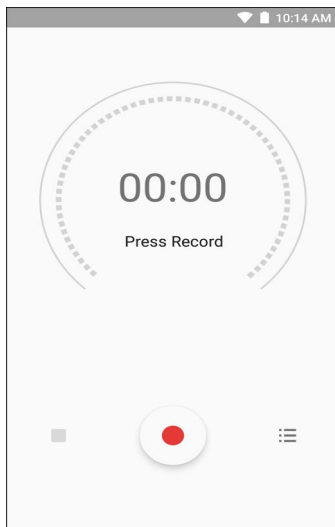

Data Capture

This section provides information for capturing barcode data using various scanning options.

The device supports data capture using:

- Integrated imager
- RS507 Hands-free Imager
- RS6000 Bluetooth Ring Scanner
- DS3678 Digital Scanner.

Imaging

The imager uses imaging technology to take a picture of a bar code, stores the resulting image in its memory, and executes state-of-the-art software decoding algorithms to extract the bar code data from the image. With a 2D imager, the device has the following features:

- Omnidirectional reading of a variety of bar code symbologies, including the most popular linear, postal, PDF417, and 2D matrix code types.
- Advanced intuitive laser aiming cross-hair and dot aiming for easy point-and-shoot operation.

Operational Modes

The device with an integrated imager supports two modes of operation, listed below. Activate each mode by pressing the Scan button.

- **Decode Mode:** In this mode, the device attempts to locate and decode enabled barcodes within its field of view. The imager remains in this mode as long as the user holds the scan button, or until it decodes a barcode.



NOTE: To enable Pick List Mode, configure in DataWedge or set in an application using a API command.

- **Pick List Mode:** This mode allows the user to selectively decode a barcode when more than one barcode is in the device's field of view. To accomplish this, move the aiming crosshair or dot over the required barcode to decode only this barcode. This feature is ideal for pick lists containing multiple barcodes and manufacturing or transport labels containing more than one barcode type (either 1D or 2D).

RS507/RS507X Hands-Free Imager

The RS507/RS507X Hands-free Imager is a wearable barcode scan solution for both 1D and 2D barcode symbologies.

Figure 96 RS507/RS507X Hands-Free Imager

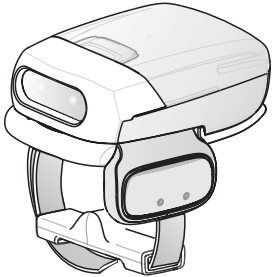

Refer to the RS507/RS507X Hands-free Imager Product Reference Guide for more information.

RS6000 Bluetooth Ring Scanner

The RS6000 Bluetooth Ring Scanner is a wearable barcode scan solution for both 1D and 2D barcode symbologies.

Figure 97 RS6000 Bluetooth Ring Scanner

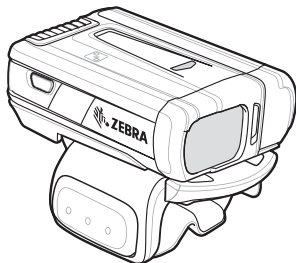

Refer to the RS6000 Bluetooth Ring Scanner Product Reference Guide for more information.

DS3678 Digital Scanner

The cordless DS3678 combines superior 1D and 2D omnidirectional barcode scanning performance and advanced ergonomics in a lightweight design. See the DS36X8 Product Reference Guide for more information.

Figure 98 DS3678 Digital Scanner

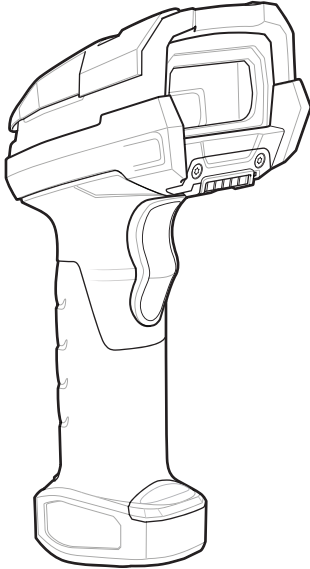

Scanning Considerations

Typically, scanning is a simple matter of aim, scan, and decode, with a few quick trial efforts to master it. However, consider the following to optimize scanning performance:

- **Range:** Scanners decode best over a particular working range — minimum and maximum distances from the barcode. This range varies according to barcode density and scanning device optics. Scan within range for quick and constant decodes; scanning too close or too far away prevents decodes. Move the scanner closer and further away to find the right working range for the barcodes being scanned.
- **Angle:** Scanning angle is important for quick decodes. When the illumination/flash reflects directly back into the imager, the specular reflection can blind/saturate the imager. To avoid this, scan the barcode so that the beam does not bounce directly back. Do not scan at too sharp an angle; the scanner needs to collect scattered reflections from the scan to make a successful decode. Practice quickly shows what tolerances to work within.
- Hold the device farther away for larger symbols.
- Move the device closer for symbols with bars that are close together.



NOTE: Scanning procedures depend on the app and device configuration. An app may use different scanning procedures from the one listed above.

Scanning with Internal Imager

To read a barcode, a scan-enabled app is required. The device contains the DataWedge app that allows the user to enable the imager, decode the barcode data, and display the barcode content.

To scan with the internal imager:

1. Ensure that an app is open on the device and a text field is in focus (text cursor in text field).

2. Point the exit window on the top of the device at a barcode.

Figure 99 Imager Scanning

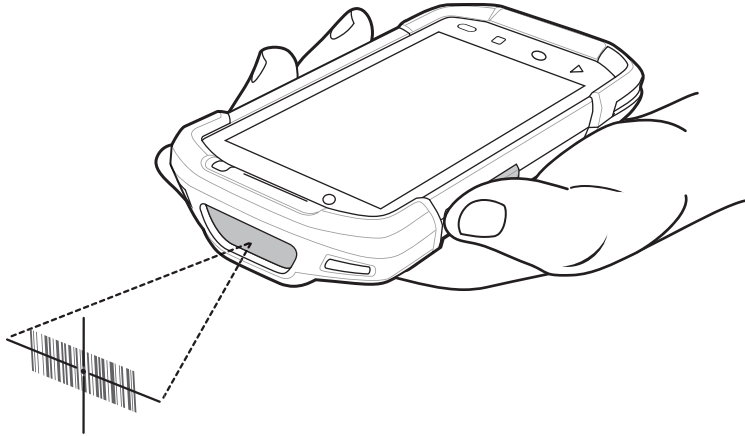

3. Press and hold the scan button.
The red laser aiming pattern turns on to assist in aiming.



NOTE: When the device is in Picklist mode, the imager does not decode the barcode until the crosshair or aiming dot touches the barcode.

4. Ensure the barcode is within the area formed by the crosshairs in the aiming pattern. The aiming dot increases visibility in bright lighting conditions.

Figure 100 Aiming Pattern

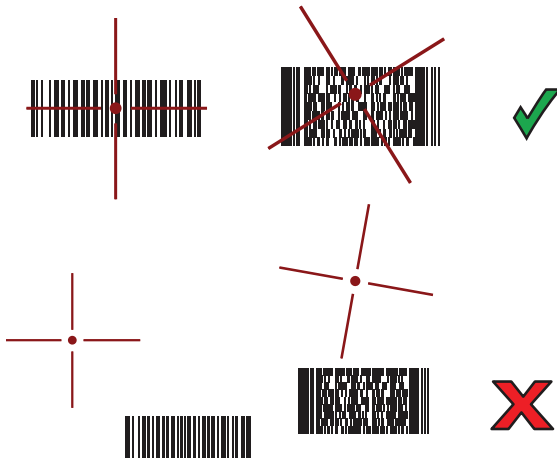

Figure 101 Pick List Mode with Multiple Barcodes



5. The Data Capture LED lights green and a beep sounds, by default, to indicate the barcode was decoded successfully.

6. Release the scan button.

The barcode content data displays in the text field.



NOTE: Imager decoding usually occurs instantaneously. The device repeats the steps required to take a digital picture (image) of a poor or difficult barcode as long as the scan button remains pressed.

Scanning with RS507/RS507X Hands-Free Imager

To read a barcode, a scan-enabled app is required. The device contains the DataWedge app that allows you to enable the scanner to decode barcode data and display the barcode content.

To scan with the RS507/RS507X:

1. Pair the RS507/RS507X with the device. See [Pairing Using Simple Serial Interface](#), [Pairing Bluetooth Scanners](#) or [Pairing Using Bluetooth Human Interface Device](#) for more information.
2. Ensure that an app is open on the device and a text field is in focus (text cursor in text field).
3. Point the RS507/RS507X at a barcode.

Figure 102 Barcode Scanning with RS507/RS507X

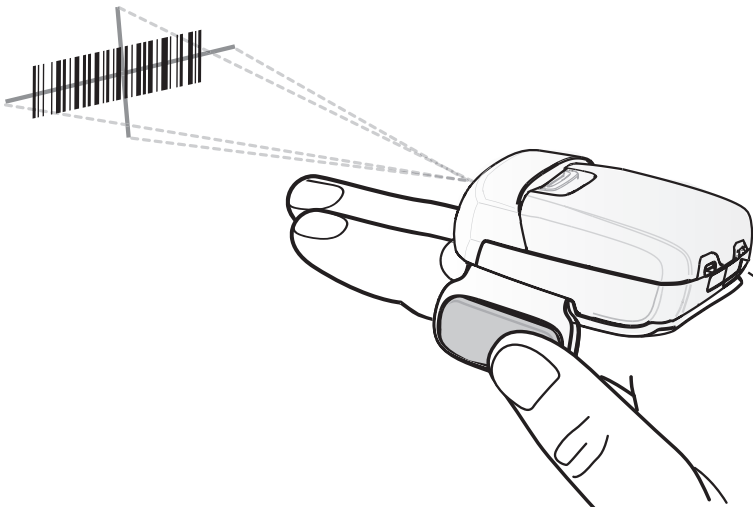

4. Press and hold the trigger.

The red laser aiming pattern turns on to assist in aiming. Ensure the barcode is within the area formed by the cross-hairs in the aiming pattern. The aiming dot increases visibility in bright lighting conditions.

The RS507/RS507X LEDs light green and a beep sounds to indicate the barcode was decoded

successfully. When the RS507/RS507X is in Pick List mode, the RS507/RS507X does not decode the barcode until the center of the crosshair touches the barcode.

Figure 103 RS507/RS507X Aiming Pattern

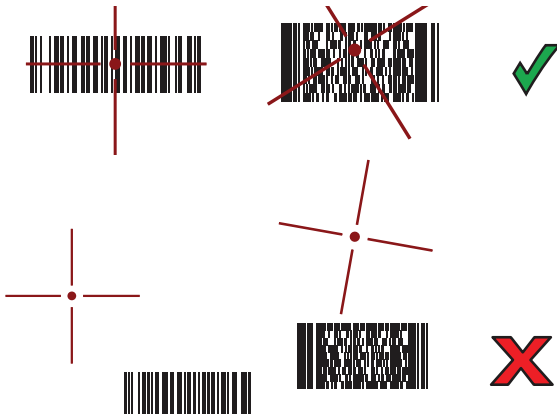

Figure 104 RS507/RS507X Pick List Mode with Multiple Barcodes in Aiming Pattern



5. The captured data appears in the text field.

Scanning with RS6000 Bluetooth Ring Scanner

To read a barcode, a scan-enabled app is required. Devices that contain the Zebra DataWedge app allows you to enable the scanner to decode barcode data and display the barcode content.

To scan with the RS6000:

1. Pair the RS6000 with the device. See [Pairing Using Bluetooth Human Interface Device](#) for more information.
2. Ensure that an app is open on the device and a text field is in focus (text cursor in text field).

- Point the RS6000 at a barcode.

Figure 105 Barcode Scanning with RS6000

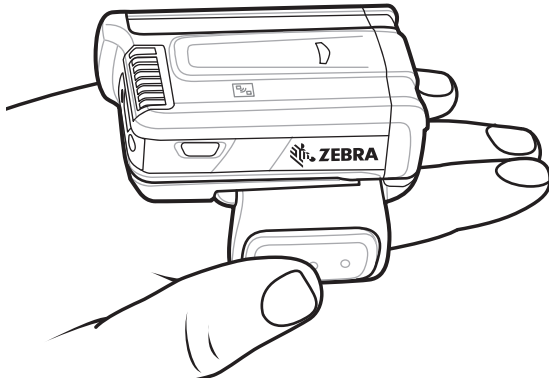

- Press and hold the trigger.

The red laser aiming pattern turns on to assist in aiming. Ensure the barcode is within the area formed by the cross-hairs in the aiming pattern. The aiming dot increases visibility in bright lighting conditions.

The RS6000 LEDs light green and a beep sounds to indicate the barcode was decoded successfully. When the RS6000 is in Pick List mode, the RS6000 does not decode the barcode until the center of the crosshair touches the barcode.

Figure 106 RS6000 Aiming Pattern

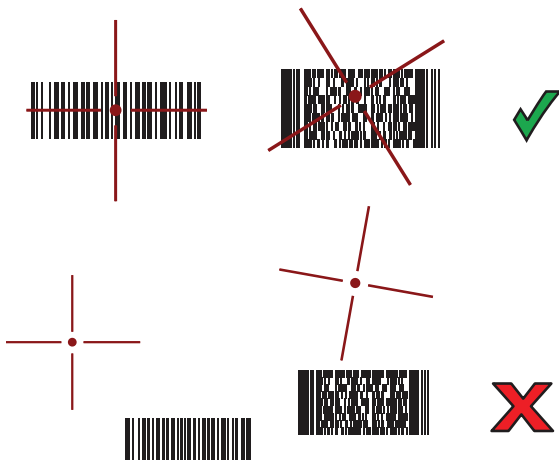

Figure 107 RS6000 Pick List Mode with Multiple Barcodes in Aiming Pattern



- The captured data appears in the text field.

Scanning with the DS3608 USB Scanner or DS3678 Bluetooth Scanner

To scan with the DS3608 or DS3678:

1. Pair the scanner with the device. For more information, see [Connecting a USB Scanner for the DS3608](#) or [Pairing Bluetooth Scanners for the DS3678](#).
2. Ensure that an app is open on the device and a text field is in focus (text cursor in text field).
3. Point the scanner at a barcode.

Figure 108 Barcode Scanning (DS3678 shown)

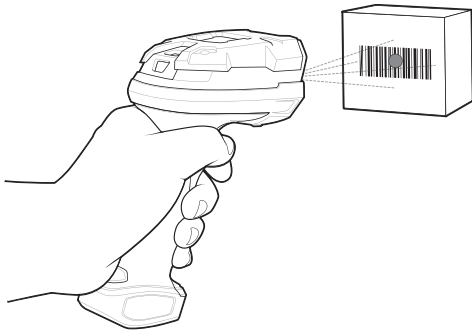

4. Press and hold the trigger.

Ensure the barcode is within the area formed by the aiming pattern. The aiming dot increases visibility in bright lighting conditions.

Figure 109 DS3608/DS3678 Aiming Pattern

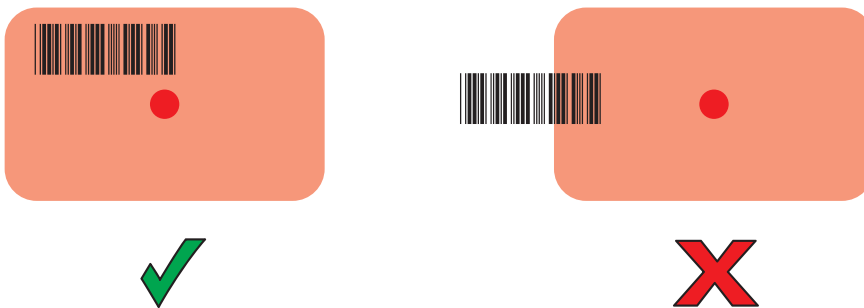
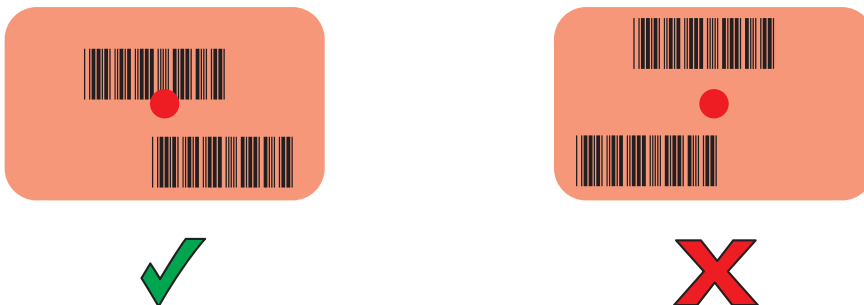

Figure 110 DS3608/DS3678 Pick List Mode with Multiple Barcodes in Aiming Pattern



5. The captured data appears in the text field.

Pairing the RS507/RS507X/RS6000 Hands-Free Imager

To connect the RS507/RS507X or RS6000 imager to the device, use one of the following methods:

- Near Field Communication (NFC) (RS6000 only)
- Simple Serial Interface (SSI)
- Bluetooth Human Interface Device (HID) Mode.

Pairing Using Near Field Communication

The device provides the ability to pair the RS6000 using NFC.



NOTE: RS6000 Only.

To pair using NFC:

1. Ensure that the RS6000 is in SSI mode. Refer to the RS6000 User Guide for more information.
2. Ensure that NFC is enabled on the device.
3. Align the NFC icon on the RS6000 with the NFC antenna on the device.

The RS6000 Status LED blinks blue indicating that the RS6000 is attempting to establish connection with the device. When connection is established, the Status LED turns off and the RS6000 emits a single string of low/high beeps.

A notification appears on the Notification panel and the  icon appears in the Status bar.

Figure 111 Align NFC Antennas

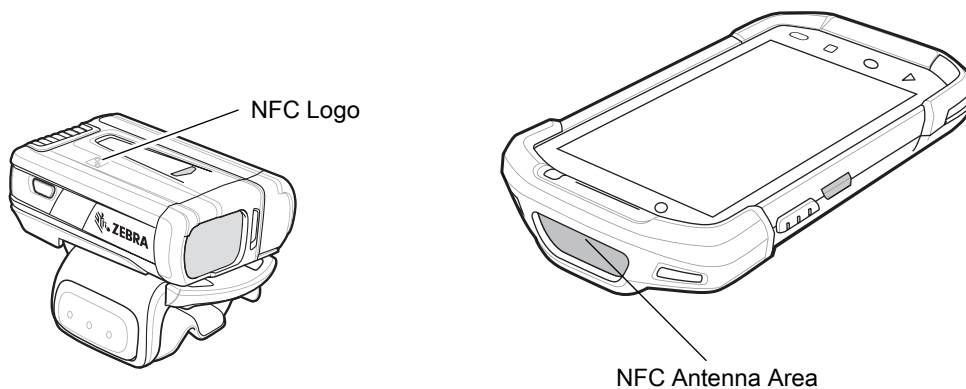

Pairing in HID Mode Using Near Field Communication

The device provides the ability to pair the RS6000 in HID mode using NFC.



NOTE: RS6000 Only.

To pair in HID mode using NFC:

1. Ensure that NFC is enabled on the device.
2. Ensure that Bluetooth is enabled on the device.

3. Place the RS6000 in Human Interface Device (HID) mode. If the RS6000 is already in HID mode, skip to step 4.
 - a. Remove the battery from the RS6000.
 - b. Press and hold the Restore key.
 - c. Install the battery onto the RS6000.
 - d. Keep holding the Restore key for about five seconds until a chirp is heard and the Scan LEDs flash green.
 - e. Scan the barcode below to place the RS6000 in HID mode.

Figure 112 RS6000 Bluetooth HID Barcode

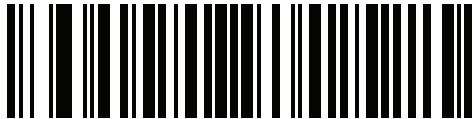

4. Remove the battery from the RS6000.
5. Re-install the battery into the RS6000.
6. Align the NFC icon on the RS6000 with the NFC antenna on the device.

The RS6000 Status LED blinks blue indicating that the RS6000 is attempting to establish connection with the device. When connection is established, the Status LED turns off and the RS6000 emits a single string of low/high beeps.

A notification appears on Notification panel and the **A** icon appears in the Status bar.

Figure 113 Align NFC Antennas

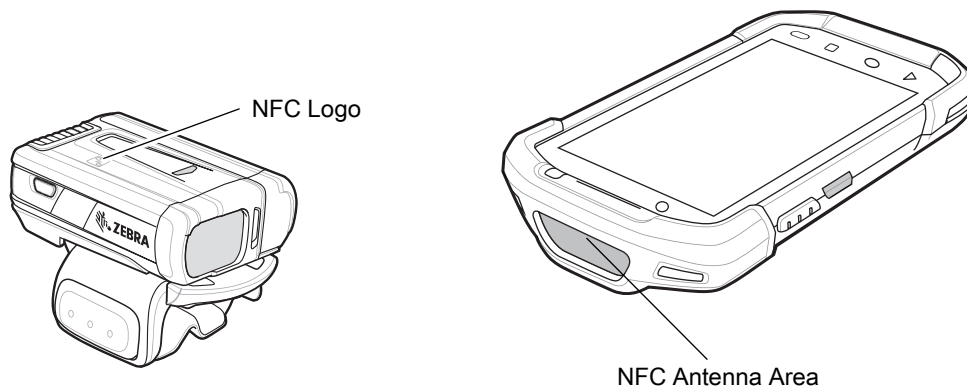

Pairing Using Simple Serial Interface (SSI)

To pair the RS507/RS507X or RS6000 with the device using SSI.

1. Swipe up from the bottom of the Home screen and touch .

Figure 114 Bluetooth Pairing Utility



2. Using the RS507/RS507X or RS6000, scan the barcode on the screen.

The RS507/RS507X or RS6000 emits a string of high/low/high/low beeps. The Scan LED flashes green indicating that the RS507/RS507X or RS6000 is attempting to establish connection with the device. When connection is established, the Scan LED turns off and the RS507/RS507X or RS6000 emits one string of low/high beeps.

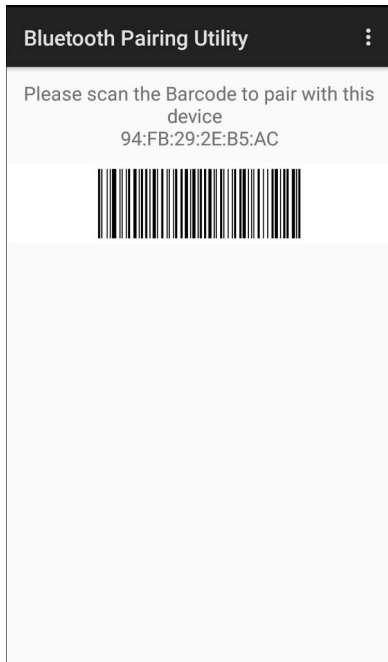
A notification appears on the Notification panel and the  icon appears in the Status bar.

Pairing Using Bluetooth Human Interface Device

To pair the RS507/RS507X or RS6000 with the device using Human Interface Device (HID):

1. Ensure that Bluetooth is enabled on both devices.
2. Ensure that the Bluetooth device to discover is in discoverable mode.
3. Ensure that the two devices are within 10 meters (32.8 feet) of one another.
4. Place the RS507/RS507X or RS6000 in HID mode. If the RS507/RS507X or RS6000 is already in HID mode, skip to step 5.
 - a. Remove the battery from the RS507/RS507X or RS6000.
 - b. Press and hold the Restore key.
 - c. Install the battery onto the RS507/RS507X or RS6000.
 - d. Keep holding the Restore key for about five seconds until a chirp is heard and the Scan LEDs flash green.

- e. Scan the barcode below to place the RS507/RS507X or RS6000 in HID mode.

Figure 115 RS507 Bluetooth HID Barcode



Figure 116 RS6000 Bluetooth HID Barcode

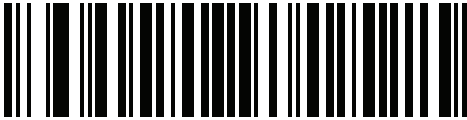

5. Remove the battery from the RS507/RS507X or RS6000.
6. Re-install the battery into the RS507/RS507X or RS6000.
7. Swipe down from the Status bar to open the Quick Access panel and then touch .
8. Touch **Bluetooth**.
9. Touch **Pair new device**. The device begins searching for discoverable Bluetooth devices in the area and displays them under **Available devices**.
10. Scroll through the list and select RS507/RS507X or RS6000.

The device connects to the RS507/RS507X or RS6000 and **Connected** appears below the device name. The Bluetooth device is added to the **Paired devices** list and a trusted (“paired”) connection is established.

A notification appears on Notification panel and the  icon appears in the Status bar.

Pairing a Bluetooth Scanner

Connect the scanner to the device using one of the following methods:

- Simple Serial Interface (SSI) mode
- Bluetooth Human Interface Device (HID) mode.

Pairing Using Bluetooth Human Interface Device

To pair the scanner with the device using HID:

1. Remove the battery from the scanner.
2. Replace the battery.
3. After the scanner reboots, scan the barcode below to place the scanner in HID mode.

Figure 117 Bluetooth HID Classic Barcode

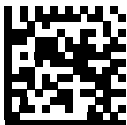

4. On the device, swipe down from the Status bar to open the Quick Access panel and then touch .
5. Touch **Bluetooth**.
6. Touch **Pair new device**. The device begins searching for discoverable Bluetooth devices in the area and displays them under **Available devices**.
7. Scroll through the list and select XXXXX xxxxxx, where XXXXX is the scanner and xxxxxx is the serial number.



The device connects to the scanner, the scanner beeps once and **Connected** appears below the device name. The Bluetooth device is added to the **Paired devices** list and a trusted (“paired”) connection is established.

DataWedge



DataWedge is a utility that adds advanced barcode scanning capability to any application without writing code. It runs in the background and handles the interface to built-in barcode scanners. The captured barcode data is converted to keystrokes and sent to the target application as if it was typed on the keypad.

To configure DataWedge refer to the device Integrator Guide.

Enabling DataWedge

1. Swipe up from the bottom of the Home screen and touch .
2. Touch  > **Settings**.
3. Touch the **DataWedge enabled** checkbox. A blue checkmark appears in the checkbox indicating that DataWedge is enabled.
4. Touch .

Disabling DataWedge

1. Swipe up from the bottom of the Home screen and touch .
2. Touch  > **Settings**.
3. Touch the **DataWedge enabled** checkbox. A blue checkmark disappears from the checkbox indicating that DataWedge is disabled.
4. Touch .

Calls

Make a phone call from the **Phone** app, the **Contacts** app, or other apps or widgets that display contact information.



NOTE: This section applies to WWAN devices only.

Emergency Calling

The service provider programs one or more emergency phone numbers, such as 911 or 999, that the user can call under any circumstances, even when the phone is locked, a SIM card is not inserted or the phone is not activated. The service provider can program additional emergency numbers into the SIM card. However, the SIM card must be inserted in the device in order to use the numbers stored on it. See the service provider for additional information.



NOTE: Emergency numbers vary by country. The phone's pre-programmed emergency number(s) may not work in all locations, and sometimes an emergency call cannot be placed due to network, environmental, or interference issues.

Audio Modes

The device offers three audio modes for use during phone calls:

- **Handset Mode** - Switch audio to the receiver at the top front of the device to use the device as a handset. This is the default mode.
- **Speaker Mode** - Use the device as a speakerphone.
- **Headset Mode** - Connect a Bluetooth or wired headset to automatically switch audio to the headset.

Using a Bluetooth Headset

Use a Bluetooth headset for audio communication when using an audio-enabled app. See [Bluetooth](#) for information on connecting a Bluetooth headset to the device. Set the volume appropriately before putting on the headset. When a Bluetooth headset is connected, the speakerphone is muted.

Using a Wired Headset

Use a wired headset and audio adapter for audio communication when using an audio-enabled app. Set the volume appropriately before putting on the headset. When a wired headset is connected, the speakerphone is muted.

To end a call using the wired headset, press and hold the headset button until the call ends.

Figure 118 3.5 mm Headset Adapter

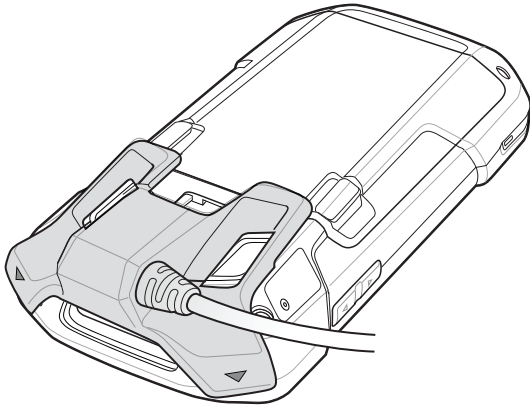

Adjusting Audio Volume

Use the volume buttons to adjust the phone volume in the following ways:

- Ring and notification volumes when not in a call
- Conversation volume during a call.

Making a Call Using the Dialer

Use the dialer tab to dial phone numbers.



1. On the Home screen touch .
2. Touch .

Figure 119 Dialer Screen



3. Touch the keys to enter the phone number.



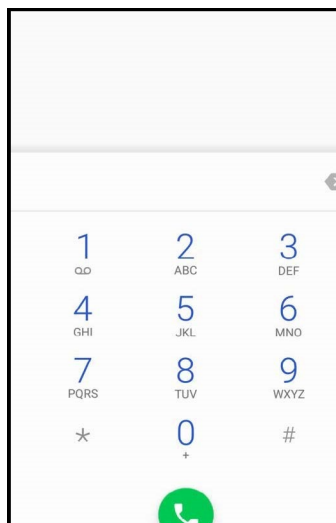



4. Touch  below the dialer to initiate the call.

Figure 120 Call in Progress





-  - Send audio to the speakerphone.
-  - Mute the call.
-  - Display the dial pad.
-  - Place the call on hold (not available on all services).
-  - Create a conference call.
-  - Increase audio level.

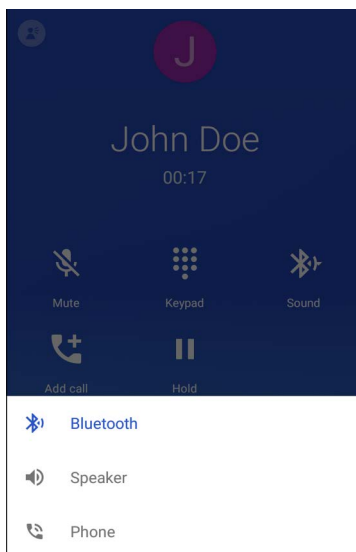

5. Touch  to end the call.

If using a Bluetooth headset, additional audio options are available. Touch the audio icon to open the audio menu.

Figure 121 Bluetooth Audio Options



-  - Audio is routed to the Bluetooth headset.

-  - Audio is routed to the speakerphone.
-  - Audio is routed to the earpiece.

Dialer Dialing Options

The dialer provides options to save the dialed number to contacts, send an SMS, or insert pauses and wait into the dial string.

Enter at least one digit to access these options. Touch  to access the following.

- **Add 2-sec pause** - Pause the dialing of the next number for two seconds. Multiple pauses are added sequentially.
- **Add wait** - Wait for confirmation to send the rest of the digits.

Making a Call Using Contacts

There are two ways to make a call using contacts:

- Using the Dialer
- Using the Contacts app.

Using the Dialer





1. On the Home screen touch .
2. Touch the  tab.

Figure 122 Dialer Contacts Tab

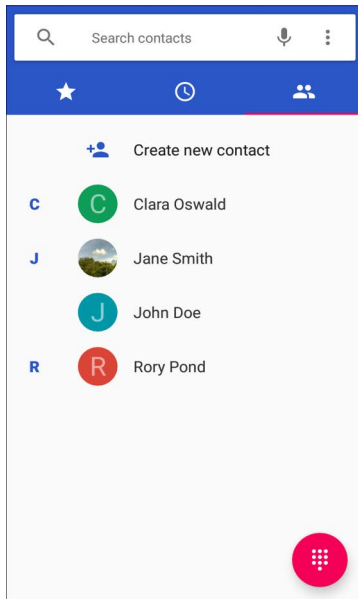

3. Touch the contact.
4. Touch  to initiate the call.
5. Touch  to end the call.

Using the Contacts App

To make a call from the Contacts app:

1. Touch .

Figure 123 Contact app



2. Touch a contact name.

Figure 124 Contact Information

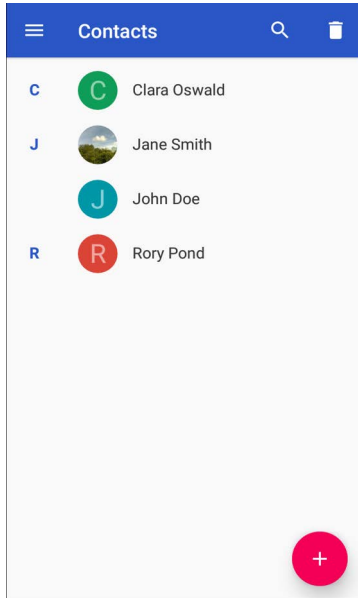
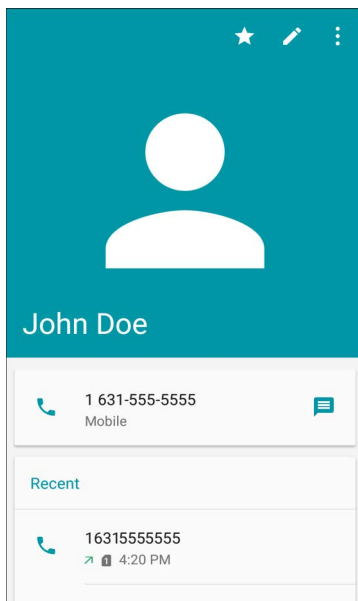



3. Touch to initiate a call.

Making a Call Using Call History

Call History is a list of all the calls placed, received, or missed. It provides a convenient way to redial a number, return a call, or add a number to Contacts.

Arrow icons beside a call indicate the type of call. Multiple arrows indicate multiple calls:

-  - Missed incoming call
-  - Received incoming call
-  - Outgoing call.





1. On the Home screen touch .
2. Touch the  tab.

Figure 125 Call History Tab



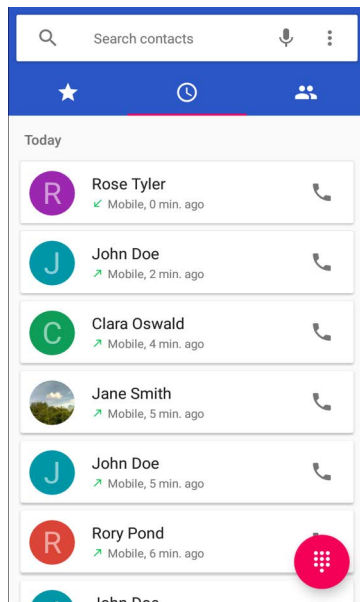

3. Touch  next to the contact to initiate the call.
4. Touch the contact to perform other functions.
5. Touch  to end the call.

Making a Conference Call



NOTE: Conference Calling and the number of conference calls allowed may not be available on all services. Please check with the service provider for Conference Calling availability.

To create a conference phone session with multiple people:

1. On the Home screen, touch .
2. Touch .
3. Touch the keys to enter the phone number.
4. Touch  below the dialer to initiate the call.



5. When the call connects, touch .
6. The first call is placed on hold.
7. Touch .
8. Touch the keys to enter the second phone number.
9. Touch  below the dialer to initiate the call.
When the call connects, the first call is placed on hold and the second call is active.

Figure 126 Two Calls





10. Touch  to create a conference call with three people.

Figure 127 Merged Calls



11. Touch  to add another call.

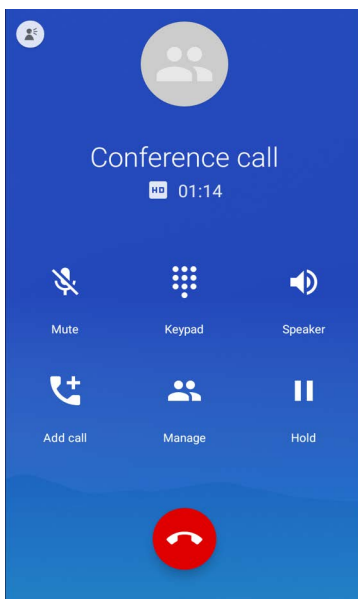





12. The conference is placed on hold.
13. Touch .
14. Touch the keys to enter the third phone number.
15. Touch  below the dialer to initiate the call.
16. Touch  to add the third call to the conference.
17. Touch **Manage conference call** to view all callers and perform the following actions:
 -  - Remove a caller from the conference
 -  - Speak privately with one party during a conference call
 -  - Include all parties again.

Figure 128 Manage Conference Call



Making a Call Using a Bluetooth Headset

To make a call using a Bluetooth headset:

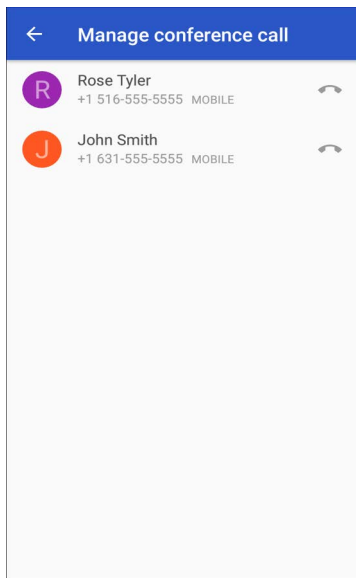
1. Pair the Bluetooth headset with the device.
2. Press the Call button on the Bluetooth headset.
3. Press the Call button on the Bluetooth headset to end the call.

Answering Calls

When receiving a phone call, the **Incoming Call** screen displays the caller ID and any additional information about the caller that is in the **Contacts** app.

Figure 129 Incoming Call Screen

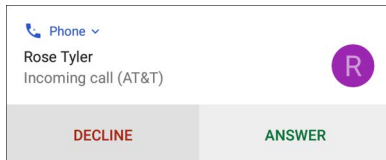



Touch **ANSWER** to answer the call or **DECLINE** to send the caller to voice mail.

If the screen lock is enabled, the user can answer the call without unlocking the device.

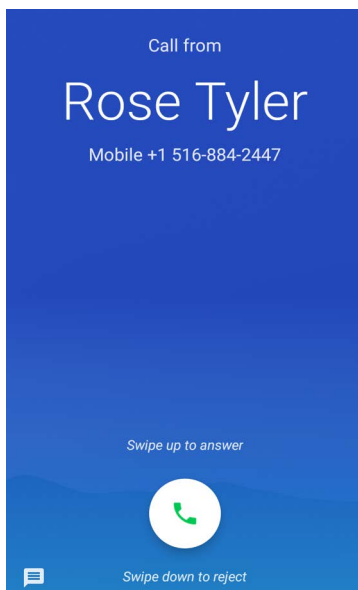
Figure 130 Incoming Call Locked Screen



When a call arrives:

- Touch  and slide up to answer the call.
- Touch  and slide down to send the call to voice mail.
- Touch  to open a list of quick text responses. Touch one to send it to the caller immediately.

When the calls ends, the device remains locked.

If using a Bluetooth headset when a call arrives, touch the Call button on the Bluetooth headset to answer the call. To end the call press the headset Call button.

All incoming calls are recorded in the Phone app Call log tab. If you miss a call, you receive a notification. To silence the ringer before answering the call, press the volume down button on the side of device.

Call Settings



NOTE: Not all options are available for all configurations.

To modify phone call settings, on the Home screen touch  >  > **Settings**.

- **Display options**
 - **Sort by** - Set to **First name** or **Last name**.
 - **Name format** - Set to **First name first** or **Last name first**.
- **Sounds and vibrations**
 - **Phone ringtone** - Select a ringtone to sound when an incoming call is received.
 - **Also vibrate for calls** - Check to make the device vibrate when a call is received (default - disabled).
 - **keypad tones** - Check to play a sound when a phone key is touched (default - enabled).
- **Quick responses** - Touch to edit quick responses to use instead of answering a call.
- **Speed dial settings** - Set speed dial contact shortcuts.
- **Calls**
 - **Calling accounts**
 - **Receive incoming calls** - Enable to allow incoming calls (default - disabled).
 - **Call forwarding** - Set to forward incoming calls to a different phone number.
 - **Call waiting** - Set to be notified of an incoming call while on a call.



NOTE: Call Forwarding may not be available on all networks. Check with the service provider for availability.

- **Additional settings**
 - **Caller ID** - Set caller ID to reveal the identity of the person making an outgoing call. Options: **Network default** (default), **Hide number**, **Show number**.
- **Call blocking** - Set to block calls and texts from certain phone numbers. Touch **ADD A NUMBER** to block a phone number.
- **Voicemail** - Configure voicemail settings.
 - **Notifications**
 - **Importance** - Set the notification importance to **Urgent**, **High** (default), **Medium**, or **Low**.
 - **Sound** - Select a sound to play when a voicemail is received.
 - **Vibrate** - Set vibrate to **On** (default) or **Off**.
 - **Advanced** - Use toggle switches to enable or disable **Blink link**, **Show notification**, or **Override Do Not Disturb**. Available options vary depending on the Importance setting.
 - **Advanced Settings**
 - **Service** - Set the service provider or other provider for voicemail service.
 - **Setup** - Select to update the phone number used to access voicemail.
- **Accessibility**
 - **TTY mode** - Touch to set the TTY setting. Use an optional teletypewriter (TTY) with the device to send and receive calls. Plug the TTY into the device headset jack and set the device to operate in one of the TTY modes.



NOTE: Use a TSB-121 compliant cable (provided by the TTY manufacturer) to connect the TTY to the device.

Set the device volume to a middle level setting for proper operation. If you experience a high number of incorrect characters, adjust the volume as needed to minimize the error rate.

For optimal performance, the device should be at least 30 cm (12 inches) from the TTY. Placing the device too close to the TTY may cause high error rates.

- **TTY off** - TTY is off (default)
- **TTY Full** - Transmit and receive TTY characters
- **TTY HCO** - Transmit TTY characters, but receive by listening to earpiece
- **TTY VCO** - Receive TTY characters, but transmit by speaking into microphone.

Wireless

This section provides information on the wireless features of the device.

The following wireless features are available on the device:

- Wireless Wide Area Network (WWAN)
- Wireless Local Area Network (WLAN)
- Bluetooth
- Near Field Communications (NFC)
- Cast.

Wireless Wide Area Networks

Use Wireless wide area networks (WWANs) to access data over a cellular network. This section provides information on:

- Sharing a data connection
- Monitoring data usage.
- Changing Cellular Network settings
- Locking a SIM card.

Sharing the Mobile Data Connection

The **Tethering & Portable Hotspot** settings allows sharing the mobile data connection with a single computer via USB tethering or Bluetooth tethering. Share the data connection with up to eight devices at once, by turning it into a portable Wi-Fi hotspot. While the device is sharing its data connection, an icon displays at the top of the screen and a corresponding message appears in the notification list.

Enabling USB Tethering



NOTE: USB tethering is not supported on computers running Mac OS. If the computer is running Windows or a recent version of Linux (such as Ubuntu), follow these instructions without any special preparation. If running a version of Windows that precedes Windows 7, or some other operating system, you may need to prepare the computer to establish a network connection via USB.

1. Connect the device to a host computer with the USB cable.
2. The notification **USB charging this device** appears in the Notifications panel.
3. Swipe down from the Status bar to open the Quick Access panel and then touch .

4. Touch **Network & Internet**.
5. Touch **Hotspot & tethering**.
6. Touch the **USB tethering** switch to enable.
The host computer is now sharing the device's data connection.

To stop sharing the data connection, touch the **USB tethering** switch again or disconnect the USB cable.

Enabling Bluetooth Tethering

Use Bluetooth tethering to share the data connection with a host computer.

Configure the host computer to obtain its network connection using Bluetooth. For more information, see the host computer's documentation.

1. Pair the device with the host computer.
2. Swipe down from the Status bar to open the Quick Access panel and then touch .
3. Touch **Networking & Internet**.
4. Touch **Hotspot & tethering**.
5. Touch the **Bluetooth tethering** switch to enable.
The host computer is now sharing the device's data connection.

To stop sharing the data connection, touch the **Bluetooth tethering** switch again.

Enabling Wi-Fi Hotspot

To enable the Wi-Fi Hotspot:

1. Swipe down from the Status bar to open the Quick Access panel and then touch .
2. Touch **Network & Internet**.
3. Touch **Hotspot & tethering**.
4. Touch the **Wi-Fi hotspot** switch to enable.
After a moment, the device starts broadcasting its Wi-Fi network name (SSID). Connect to it with up to eight computers or other devices. The Hotspot (📶) icon appears in the Status bar.

To stop sharing the data connection, touch the **Portable Wi-Fi hotspot** switch again.

Configuring the Wi-Fi Hotspot

1. Swipe down from the Status bar to open the Quick Access panel and then touch .
2. Touch **Network & Internet**.
3. Touch **Hotspot & tethering**.

4. Touch **Set up Wi-Fi hotspot**.

Figure 131 Set up Wi-Fi Hotspot Dialog Box

5. In the **Network name** text field, edit the name for the hotspot.
6. Touch the **Security** option and select a security method from the drop-down list.
 - **None**
 - **WPA2 PSK**.



NOTE: If **None** is selected in the **Security** option, a password is not required.

7. In the **Password** text field, enter a password, if required.
8. In the **Select AP Band** drop-down list, select **2.4 GHz Band** or **5 GHz Band**.
9. Touch **Save**.

Cellular Network Settings

The following sections provide settings for cellular networks.

Disabling Data When Roaming

To prevent the device from transmitting data over other carriers' mobile networks when leaving an area that is covered by the carrier's networks. This is useful for controlling expenses if the service plan does not include data roaming.

CDMA Devices

1. Swipe down from the Status bar to open the Quick Access panel and then touch .
2. Touch **Network & Internet > Mobile network > Data roaming access**.
3. Select the roaming option and then touch **OK**.

GSM Devices

1. Swipe down from the Status bar to open the Quick Access panel and then touch .
2. Touch **Network & Internet > Mobile network**.
3. Slide the **Roaming** switch to the off position.

Preferred Network Type

Use to change the network operating mode.

1. Swipe down from the Status bar to open the Quick Access panel and then touch .
2. Touch **Network & Internet > Mobile network > Preferred network type**.
3. In the **Preferred network type** dialog box, select a mode to set as default:
 - **LTE**
 - **3G**
 - **2G**.

Enhanced 4G LTE Mode

Use LTE services to improve voice and other communication. This option is enabled by default.

Using Search for MicroCell

A MicroCell acts like a mini cell tower in a building or residence and connects to an existing broadband Internet service. It improves cell signal performance for voice calls, texts, and cellular data applications like picture messaging and Web surfing.

1. Swipe down from the Status bar to open the Quick Access panel and then touch .
2. Touch **Network & Internet > Mobile network**.
3. Touch **Search for AT&T MicroCell**.

Using System Select

Use System select to change the CDMA roaming mode.



1. Swipe down from the Status bar to open the Quick Access panel and then touch .
2. Touch **Network & Internet > Mobile network > System Select**.
3. In the **System select** dialog box, select:
 - **Home only** - Do not roam from Home network.
 - **Automatic** - Allow automatic roaming.
4. Touch



Configuring the Access Point Name



NOTE: Many service provider Access Point Name (APN) data are pre-configured in the device. The APN information for all other service providers must be obtained from the wireless service provider.

To use the data on a network, configure the APN information:

1. Swipe down with two fingers from the status bar to open the quick access panel and then touch .
2. Touch **Network & Internet > Mobile network > Advanced**.
3. Touch **Access Point Names**.
4. Touch an APN name in the list to edit an existing APN or touch  to create a new APN.
5. Touch each APN setting and enter the appropriate data obtained from the wireless service provider.

6. When finished, touch  > **Save**.
7. Touch the radio button next to the APN name to start using it.
8. Touch .

Locking the SIM Card

Locking the SIM card requires the user to enter a PIN every time the device is turned on. If the correct PIN is not entered, only emergency calls can be made.

1. Swipe down from the Status bar to open the Quick Access panel and then touch .
2. Touch **Security & location**.
3. Touch **SIM card lock**.
4. Touch **Lock SIM card**.
5. Enter the PIN associated with the card. Touch **OK**.
6. Reset the device.

Data Usage

Data usage refers to the amount of data uploaded or downloaded by the device during a given period. Depending on the wireless plan, you may be charged additional fees when your data usage exceeds your plan's limit.

To monitor your data usage:

1. Swipe down from the Status bar to open the Quick Access panel and then touch .
2. Touch **Mobile network > Data usage > Data saver**.



CAUTION: The usage displayed on the data usage settings screen is measured by your device. Your carrier's data usage accounting may differ. Usage in excess of your carrier plan's data limits can result in steep overage charges. The feature described here can help you track your usage, but is not guaranteed to prevent additional charges.



Data usage settings allow:

- Set the data usage warning level.
- Set a data usage limit.
- View or restrict data usage by app.
- Identify mobile hotspots and restrict background downloads that may result in extra charges.

By default, the data usage settings screen displays the mobile data settings. That is, the data network or networks provided by your carrier.

Setting Data Usage Warning



To set a warning alert when the device has used a certain amount of mobile data:

1. Swipe down from the Status bar to open the Quick Access panel and then touch .
2. Touch **Data usage**.
3. Touch **Mobile data usage >  > Set data warning**.

4. Touch **Data warning**.
5. Enter a number. To switch between megabytes (MB) and gigabytes (GB), touch the down arrow.
6. Touch **SET**.

When the usage reaches the set level, a notification appears.

Setting Data Limit

1. Swipe down from the Status bar to open the Quick Access panel and then touch .
2. Touch **Data usage**.
3. Touch **Mobile data usage** >  > **Set data limit**.
4. Touch **OK**.
5. Touch **Data limit**.
6. Enter a number. To switch between megabytes (MB) and gigabytes (GB), touch the down arrow.
7. Touch **Set**.

When the limit is reached, data automatically turns off and a notification appears.

Wireless Local Area Networks

Wireless local area networks (WLANs) allow the device to communicate wirelessly inside a building. Before using the device on a WLAN, the facility must be set up with the required hardware to run the WLAN (sometimes known as infrastructure). The infrastructure and the device must both be properly configured to enable this communication.

Refer to the documentation provided with the infrastructure (access points (APs), access ports, switches, Radius servers, etc.) for instructions on how to set up the infrastructure.

Once the infrastructure is set up to enforce the chosen WLAN security scheme, use the **Wireless & networks** settings configure the device to match the security scheme.

The device supports the following WLAN security options:

- Open
- Wireless Equivalent Privacy (WEP)
- Wi-Fi Protected Access (WPA)/WPA2 Personal (PSK)
- Extensible Authentication Protocol (EAP).
 - EAP-FAST - with MSCHAPV2 and GTC authentication.

The **Status** bar displays icons that indicate Wi-Fi network availability and Wi-Fi status.



NOTE: To extend the life of the battery, turn off Wi-Fi when not in use.

Connecting to a Wi-Fi Network

To connect to a Wi-Fi network:

1. Swipe down from the Status bar to open the Quick Access panel.

Figure 132 Quick Access Panel

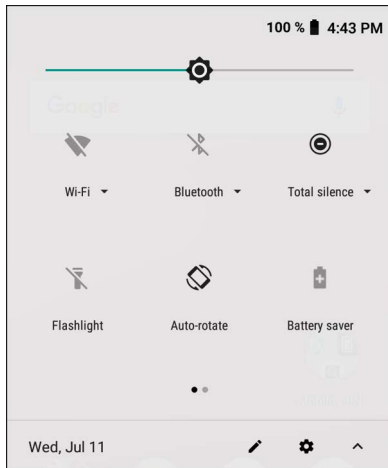

2. Touch **Wi-Fi** to open the **Wi-Fi** screen. The device searches for WLANs in the area and lists them.

Figure 133 Wi-Fi Screen

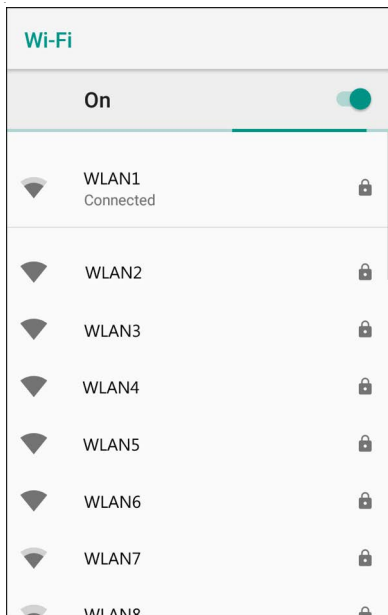



3. Scroll through the list and select the desired WLAN network.
4. For open networks, touch profile once or press and hold and then select **Connect to network** or for secure networks enter the required password or other credentials then touch **Connect**. See the system administrator for more information.

The device obtains a network address and other required information from the network using the dynamic host configuration protocol (DHCP) protocol. To configure the device with a fixed internet protocol (IP) address, Refer to the device Integrator Guide for more information.

5. In the Wi-Fi setting field, **Connected** appears indicating that the device is connected to the WLAN.

Removing a Wi-Fi Network

To remove a remembered or connected network:

1. Swipe down from the status bar to open the quick access panel and then touch .
2. Touch **Network & Internet > W-Fi**.
3. Scroll down to the bottom of the list and touch **Saved networks**.
4. Touch the name of the network.
5. In the dialog box, touch **FORGET**.
6. Touch .

Bluetooth

Bluetooth devices can communicate without wires, using frequency-hopping spread spectrum (FHSS) radio frequency (RF) to transmit and receive data in the 2.4 GHz Industry Scientific and Medical (ISM) band (802.15.1). Bluetooth wireless technology is specifically designed for short-range (10 m (32.8 ft)) communication and low power consumption.

Devices with Bluetooth capabilities can exchange information (for example, files, appointments, and tasks) with other Bluetooth enabled devices such as printers, access points, and other mobile devices.

The device supports Bluetooth Low Energy. Bluetooth Low Energy is targeted at applications in the healthcare, fitness, security, and home entertainment industries. It provides reduced power consumption and cost while maintaining standard Bluetooth range.

Adaptive Frequency Hopping

Adaptive Frequency Hopping (AFH) is a method of avoiding fixed frequency interferers, and can be used with Bluetooth voice. All devices in the piconet (Bluetooth network) must be AFH-capable in order for AFH to work. There is no AFH when connecting and discovering devices. Avoid making Bluetooth connections and discoveries during critical 802.11b communications. AFH for Bluetooth consists of four main sections:

- Channel Classification - A method of detecting an interference on a channel-by-channel basis, or pre-defined channel mask.
- Link Management - Coordinates and distributes the AFH information to the rest of the Bluetooth network.
- Hop Sequence Modification - Avoids interference by selectively reducing the number of hopping channels.
- Channel Maintenance - A method for periodically re-evaluating the channels.

When AFH is enabled, the Bluetooth radio “hops around” (instead of through) the 802.11b high-rate channels. AFH coexistence allows enterprise devices to operate in any infrastructure.

The Bluetooth radio in this device operates as a Class 2 device power class. The maximum output power is 2.5 mW and the expected range is 10 m (32.8 ft). A definition of ranges based on power class is difficult to obtain due to power and device differences, and whether in open space or closed office space.



NOTE: It is not recommended to perform Bluetooth wireless technology inquiry when high rate 802.11b operation is required.

Security

The current Bluetooth specification defines security at the link level. Application-level security is not specified. This allows application developers to define security mechanisms tailored to their specific need. Link-level security occurs between devices, not users, while application-level security can be implemented on a per-user basis. The Bluetooth specification defines security algorithms and procedures required to authenticate devices, and if needed, encrypt the data flowing on the link between the devices. Device authentication is a mandatory feature of Bluetooth while link encryption is optional.

Pairing of Bluetooth devices is accomplished by creating an initialization key used to authenticate the devices and create a link key for them. Entering a common personal identification number (PIN) in the devices being paired generates the initialization key. The PIN is never sent over the air. By default, the Bluetooth stack responds with no key when a key is requested (it is up to user to respond to the key request event). Authentication of Bluetooth devices is based-upon a challenge-response transaction. Bluetooth allows for a PIN or passkey used to create other 128-bit keys used for security and encryption. The encryption key is derived from the link key used to authenticate the pairing devices. Also worthy of note is the limited range and fast frequency hopping of the Bluetooth radios that makes long-distance eavesdropping difficult.

Recommendations are:

- Perform pairing in a secure environment
- Keep PIN codes private and do not store the PIN codes in the device
- Implement application-level security.

Bluetooth Profiles

The device supports the Bluetooth services listed in the table below:

Table 13 *Bluetooth Profiles*

Profile	Description
Service Discovery Protocol (SDP)	Handles the search for known and specific services as well as general services.
Serial Port Profile (SPP)	Allows use of RFCOMM protocol to emulate serial cable connection between two Bluetooth peer devices. For example, connecting the device to a printer.
Object Push Profile (OPP)	Allows the device to push and pull objects to and from a push server.
Advanced Audio Distribution Profile (A2DP)	Allows the device to stream stereo-quality audio to a wireless headset or wireless stereo speakers.
Audio/Video Remote Control Profile (AVRCP)	Allows the device to control A/V equipment to which a user has access. It may be used in concert with A2DP.
Personal Area Network (PAN)	Allows the use of Bluetooth Network Encapsulation Protocol to provide L3 networking capabilities over a Bluetooth link. Only PANU role is supported.
Human Interface Device Profile (HID)	Allows Bluetooth keyboards, pointing devices, gaming devices and remote monitoring devices to connect to the device.
Headset Profile (HSP)	Allows a hands-free device, such as a Bluetooth headset, to place and receive calls on the device.
Hands-Free Profile (HFP)	Allows car hands-free kits to communicate with the device in the car.

Table 13 *Bluetooth Profiles (Continued)*

Profile	Description
Phone Book Access Profile (PBAP)	Allows exchange of Phone Book Objects between a car kit and a mobile device to allow the car kit to display the name of the incoming caller; allow the car kit to download the phone book so you can initiate a call from the car display.
Out of Band (OOB)	Allows exchange of information used in the pairing process. Pairing is completed using the Bluetooth radio, but requires information from the OOB mechanism. Using OOB with NFC enables pairing when devices simply get close, rather than requiring a lengthy discovery process.
Symbol Serial Interface (SSI)	Allows for communication with Bluetooth Imager.

Bluetooth Power States

The Bluetooth radio is off by default:

- Suspend - When the device goes into suspend mode, the Bluetooth radio stays on.
- Airplane Mode - When the device is placed in Airplane Mode, the Bluetooth radio turns off. When Airplane mode is disabled, the Bluetooth radio returns to the prior state. When in Airplane Mode, the Bluetooth radio can be turned back on if desired.

Bluetooth Radio Power



Turn off the Bluetooth radio to save power or if entering an area with radio restrictions (for example, an airplane). When the radio is off, other Bluetooth devices cannot see or connect to the device. Turn on the Bluetooth radio to exchange information with other Bluetooth devices (within range). Communicate only with Bluetooth radios in close proximity.



NOTE: To achieve the best battery life, turn off radios when not in use.



Enabling Bluetooth

To enable Bluetooth:

1. Swipe down from the Status bar to open the Quick Access panel.
2. Touch  to turn Bluetooth on.
3. Touch .

Disabling Bluetooth

To disable Bluetooth:

1. Swipe down from the Status bar to open the Quick Access panel.
2. Touch  to turn Bluetooth off.
3. Touch .



Discovering Bluetooth Device(s)

The device can receive information from discovered devices without pairing. However, once paired, the device and a paired device exchange information automatically when the Bluetooth radio is on. To find Bluetooth devices in the area:

1. Ensure that Bluetooth is enabled on both devices.
2. Ensure that the Bluetooth device to discover is in discoverable mode.
3. Ensure that the two devices are within 10 meters (32.8 feet) of one another.
4. Swipe down from the Status bar to open the Quick Access panel.
5. Touch **Bluetooth**.
6. Touch **MORE SETTINGS**. The **Bluetooth** screen appears.
7. Touch **Pair new device**. The device begins searching for discoverable Bluetooth devices in the area and displays them under **Available devices**.
8. Scroll through the list and select a device. The Bluetooth pairing request dialog box appears.
9. Touch **Pair** on both devices.
10. The Bluetooth device is added to the **Paired devices** list and a trusted (“paired”) connection is established.

Changing the Bluetooth Name

By default, the device has a generic Bluetooth name that is visible to other devices when connected.

1. Swipe down from the Status bar to open the Quick Access panel and then touch .
2. Touch **Connected devices > Bluetooth**.
3. If Bluetooth is not on, move the switch to turn Bluetooth on.
4. Touch **Device name**.
5. Enter a name and touch **RENAME**.
6. Touch .



Connecting to a Bluetooth Device

Once paired, connect to a Bluetooth device.

1. Swipe down from the Status bar to open the Quick Access panel and then touch .
2. Touch **Connected device > Bluetooth**.
3. In the list, touch the unconnected Bluetooth device.
When connected, **Connected** appears below the device name.



Selecting Profiles on the Bluetooth Device

Some Bluetooth devices have multiple profiles. To select a profile:

1. Swipe down from the Status bar to open the Quick Access panel and then touch .
2. Touch **Connected Devices > Bluetooth**.
3. In the **Paired Devices** list, touch  next to the device name.
4. Turn on or off a profile to allow the device to use that profile.
5. Touch .

Unpairing a Bluetooth Device

To unpair a Bluetooth device and erase all pairing information:

1. Swipe down from the Status bar to open the Quick Access panel and then touch .
2. Touch **Connected devices > Bluetooth**.
3. In the **Paired Devices** list, touch  next to the device name.
4. Touch **FORGET**.
5. Touch .

Near Field Communications

NFC/HF RFID is a short-range wireless connectivity technology standard that enables secure transaction between a reader and a contactless smartcard. The technology is based on ISO/IEC 14443 type A and B (proximity) and ISO/IEC 15693 (vicinity) standards, using the HF 13.56 MHz unlicensed band. The device supports the following operating modes:

- Reader mode
- Peer-to-Peer communication
- Card Emulation mode.

Using NFC, the device can:

- Read contactless cards such as contactless tickets, ID cards and ePassport.
- Read and write information to contactless cards such as SmartPosters and tickets, as well as devices with NFC interface such as vending machines.
- Read information from supported medical sensors.
- Pair with supported Bluetooth devices such as printers , ring scanners (ex. RS6000), and headsets (ex. HS3100).
- Exchange data with another NFC device.
- Emulate contactless card such as payment, ticket, or SmartPoster.

The device NFC antenna is positioned to read NFC cards from the top of the device while the device is being held.

Reading NFC Cards

To read NFC cards:

1. Launch an NFC enabled application.

2. Hold device as shown.
3. Move the device close to the NFC card until it detects the card.
4. Hold the card steadily until the transaction is complete (usually indicated by the application).

Figure 134 Reading Cards

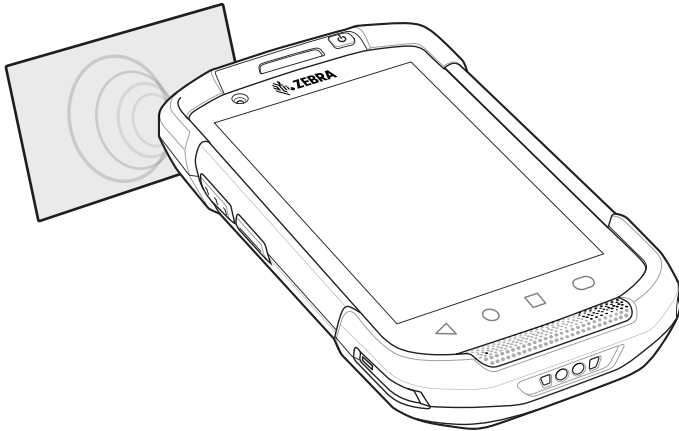

Sharing Information Using NFC

You can beam content like a web page, contact cards, pictures, YouTube links or location information from your screen to another device by bringing the devices together back to back.

Make sure both devices are unlocked, support NFC, and have both NFC and Android Beam turned on.

1. Open a screen that contains a web page, video, photo or contact.
2. Move the back of the device toward the back of the other device.

Figure 135 Sharing Data Using NFC

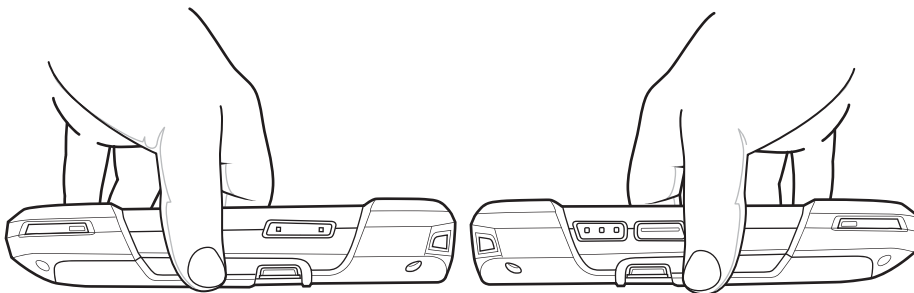



When the devices connect, a sound emits, the image on the screen reduces in size, the message **Touch to beam** displays.

3. Touch anywhere on the screen.
The transfer begins.

Cast

Use **Cast** to mirror the device screen on a Miracast enabled wireless display.

1. Swipe down from the Status bar to open the Quick Settings bar and then touch .
2. Touch **Connected Devices**.
3. Touch **Cast**.
4. Touch  > **Enable wireless display**. The device searches for nearby Miracast devices and lists them.
5. Touch a device to begin casting.
6. Touch .

Accessories

This section provides information for using the accessories for the device. The following table lists the accessories available for the device.

Table 14 Accessories

Accessory	Part Number	Description
Cradles		
2-Slot Charge Only Cradle	CRD-TC7X-SE2CPP-01	Provides device and spare battery charging. Use with power supply, p/n PWRS-14000-148R.
2-Slot USB/Ethernet Cradle	CRD-TC7X-SE2EPP-01	Provides device and spare battery charging and USB communication with a host computer and Ethernet communication with a network. Use with power supply, p/n PWRS-14000-148R.
5-Slot Charge Only Cradle	CRD-TC7X-SE5C1-01	Charges up to five devices. Use with power supply, p/n PWRS-14000-241R and DC line cord, p/n 50-16002-029R. Can accommodate one 4-Slot Battery Charger using the Battery Adapter Cup.
4-Slot Charge Only Cradle with Battery Charger	CRD-TC7X-SE5KPP-01	Charges up to four devices and four spare batteries. Use with power supply, p/n PWRS-14000-241R and DC line cord, p/n 50-16002-029R.
5-Slot Ethernet Cradle	CRD-TC7X-SE5EU1-01	Provides device charging and provides Ethernet communication for up to five devices. Use with power supply, p/n PWRS-14000-241R and DC line cord, p/n 50-16002-029R. Can accommodate one 4-Slot Battery Charger using the Battery Adapter Cup.
Cradle Mount	BRKT-SCRD-SMRK-01	Mounts the 5-Slot Charge Only Cradle, 5-Slot Ethernet Cradle, and 4-Slot Battery Charger to a wall or rack.
Batteries and Chargers		
4620 mAh PowerPrecision+ battery	BTRY-TC7X-46MPP-01 BTRY-TC7X-46MPP-10	Replacement battery (single pack). Replacement battery (10-pack).

Table 14 Accessories (Continued)

Accessory	Part Number	Description
4-Slot Spare Battery Charger	SAC-TC7X-4BTYPP-01	Charges up to four battery packs. Use with power supply, p/n PWRS-14000-148R.
Battery Charger Adapter Cup	CUP-SE-BTYADP1-01	Allows for one 4-Slot Battery Charger to be charged and docked on the left most slot of the 5-Slot cradles (maximum one per cradle).
Vehicle Solutions		
Charging Cable Cup	CHG-TC7X-CLA1-01	Provides power to the device from a cigarette lighter socket.
Charge Only Vehicle Cradle	CRD-TC7X-CVCD1-01	Charges and securely holds the device. Requires power cable CHG-AUTO-CLA1-01 or CHG-AUTO-HWIRE1-01, sold separately.
TC7X Vehicle Communication Charging Cradle	CRD-TC7X-DCVH-01	Provides power for operating the device when connected to the optional USB I/O Hub and securely holds the device.
USB I/O Hub	SHARE-USBH-01	Provides power to the TC7X Vehicle Communication Charging Cradle, USB communication and Requires power cable CHG-AUTO-CLA1-01 or CHG-AUTO-HWIRE1-01, sold separately.
TC7X Data Communication Enabled Vehicle Cradle with Hub Kit	CRD-TC7X-VCD1-01	Contains the TC7X Vehicle Communication Charging Cradle and the IUSB I/O Hub.
Cigarette Light Adapter Auto Charge Cable	CHG-AUTO-CLA1-01	Provides power to the Vehicle Cradle from a cigarette lighter socket.
Hard-wire Auto Charge Cable	CHG-AUTO-HWIRE1-01	Provides power to the Vehicle Cradle from the vehicle's power panel.
RAM Mount	RAM-B-166U	Provides window mounting option for the Vehicle Cradle. RAM Twist Lock Suction Cup with Double Socket Arm and Diamond Base Adapter. Overall Length: 6.75".
RAM Mount Base	RAM-B-238U	RAM 2.43" x 1.31" Diamond Ball base with 1" ball.
Charge and Communication Cables		
Charging Cable Cup	CHG-TC7X-CBL1-01	Provides power to the device. Use with power supply, p/n PWRS-14000-249R, sold separately.
Snap-On USB Cable	CBL-TC7X-CBL1-01	Provides power to the device and USB communication with a host computer. Use with power supply, p/n PWRS-14000-249R, sold separately.
Snap-On Serial Cable	CBL-TC7X-SERL1-01	Provides power and serial communication with a host computer. Use with power supply, p/n PWRS-14000-249R, sold separately.
Snap-On DEX Cable	CBL-TC7X-DEX1-01	Provides electronic data exchange with devices such as vending machines.

Table 14 Accessories (Continued)

Accessory	Part Number	Description
Audio Accessories		
Premium Headset	RCH51	Premium Rugged headset.
3.5 mm Audio Adapter	ADP-TC7X-AUD35-01	Snaps onto the device and provides audio to a wired headset with 3.5 mm plug.
3.5 mm Headset	HDST-35MM-PTVP-01	Use for PTT and VoIP calls.
3.5 mm Quick Disconnect Adapter Cable	ADP-35M-QDCBL1-01	Provides connection to the 3.5 mm Headset.
Scanning		
Trigger Handle	TRG-TC7X-SNP1-02	Adds gun-style handle with a scanner trigger for comfortable and productive scanning.
Carrying Solutions		
Soft Holster	SG-TC7X-HLSTR2-01	TC7X soft holster.
Rigid Holster	SG-TC7X-RHLSTR1-01	TC7X rigid holster.
Hand Strap	SG-TC7X-HSTRP2-03	Replacement hand strap with hand strap mounting clip (3-pack).
Stylus and Coiled Tether	SG-TC7X-STYLUS-03	TC7X stylus with coiled tether (3-pack).
Power Supplies		
Power Supply	PWRS-14000-249R	Provides power to the device using the Snap-On USB Cable, Snap-on Serial Cable or Charging Cable Cup. Requires AC line cord.
Power Supply	PWRS-14000-148R	Provides power to the 2-Slot cradles and 4-Slot Spare Battery Charger. Requires AC line cord.
Power Supply	PWRS-14000-241R	Provides power to the 5-Slot Charge Only cradle and the 5-Slot Ethernet Cradle. Requires DC Line Cord, p/n 50-16002-029R and country specific three wire grounded AC line cord sold separately.
DC Line Cord	50-16002-029R	Provides power from the power supply to the 5-Slot Charge Only Cradle and 5-Slot Ethernet Cradle.

2-Slot Charge Only Cradle



CAUTION: Ensure that you follow the guidelines for battery safety described in Battery Safety Guidelines on page 203.

The 2-Slot Charge Only Cradle:

- Provides 5 VDC power for operating the device.
- Charges the device's battery.

- Charges a spare battery.

Figure 136 2-Slot Charge Only Cradle

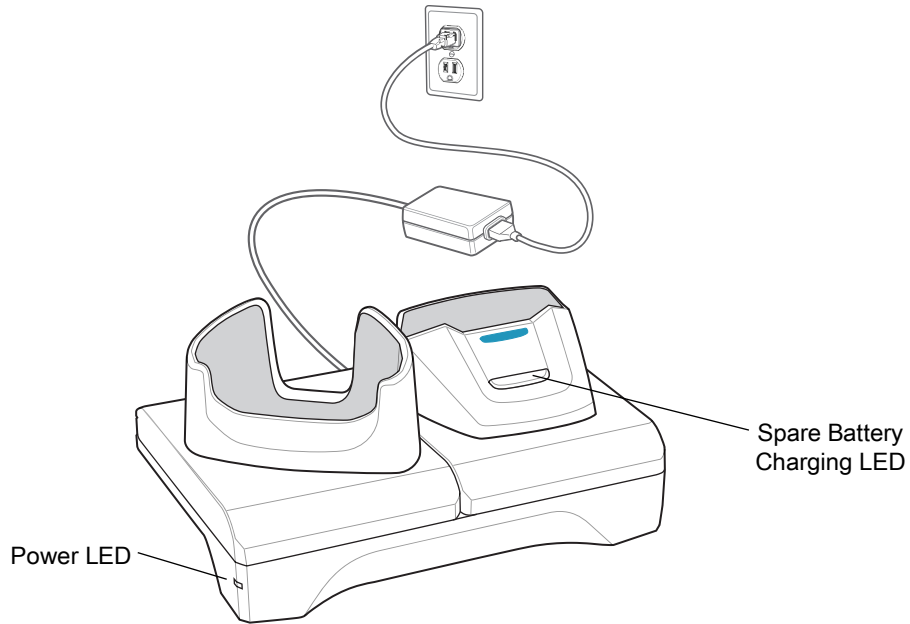

Charging the Device

1. Insert the device into the slot to begin charging.

Figure 137 Battery Charging

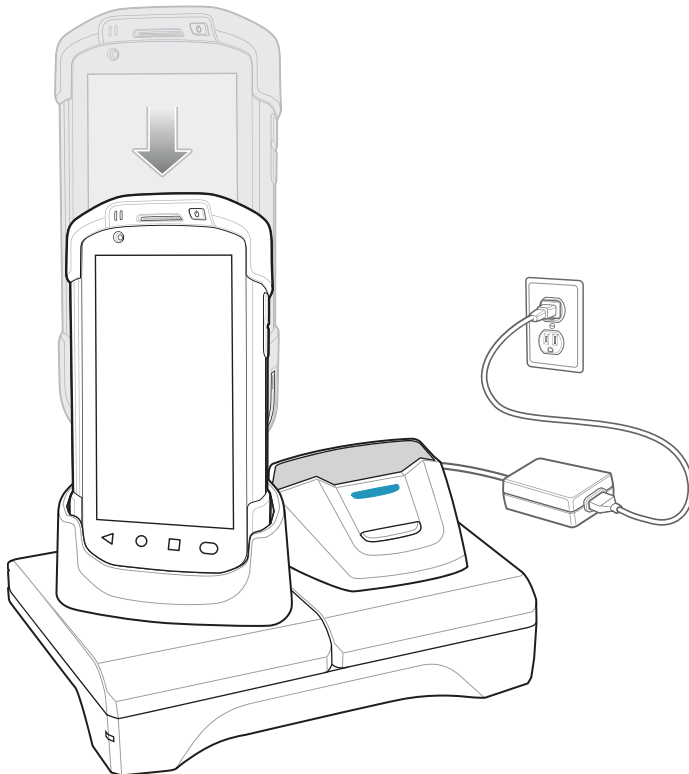

2. Ensure the device is seated properly.

Charging the Spare Battery

1. Insert the battery into the right slot to begin charging.

Figure 138 Spare Battery Charging

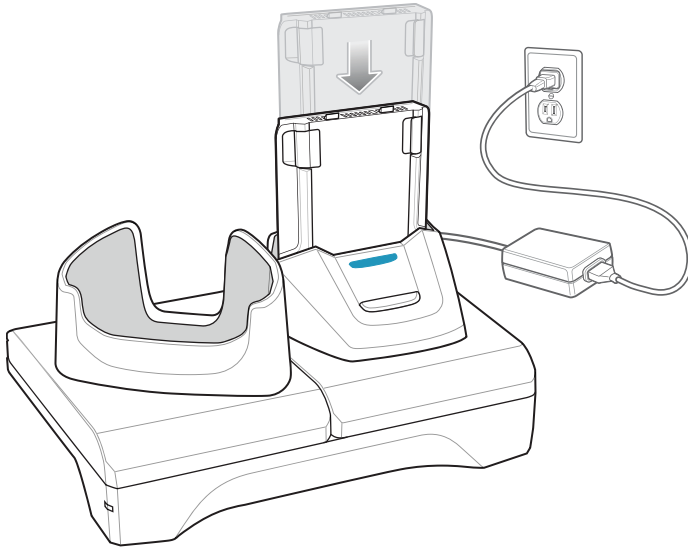

2. Ensure the battery is seated properly.

Battery Charging

Main Battery Charging

The device's Charging/Notification LED indicates the status of the battery charging in the device.

The 4620 mAh battery fully charges in less than five hours at room temperature.

Spare Battery Charging

The Spare battery Charging LED on the cup indicates the status of the spare battery charging.

The 4620 mAh battery fully charges in less than five hours at room temperature.

Table 15 Spare Battery Charging LED Indicators

LED	Indication
Slow Blinking Amber	Spare battery is charging.
Solid Green	Charging complete.
Fast Blinking Amber	Error in charging; check placement of spare battery.
Slow Blinking Red	Spare battery is charging and battery is at the end of useful life.

Table 15 Spare Battery Charging LED Indicators (Continued)

LED	Indication
Solid Red	Charging complete and battery is at the end of useful life.
Fast Blinking Red	Error in charging; check placement of spare battery and battery is at the end of useful life.
Off	No spare battery in slot; spare battery not placed correctly; cradle is not powered.

Charging Temperature

Charge batteries in temperatures from 0°C to 40°C (32°F to 104°F). The device or cradle always performs battery charging in a safe and intelligent manner. At higher temperatures (e.g. approximately +37°C (+98°F)) the device or cradle may for small periods of time alternately enable and disable battery charging to keep the battery at acceptable temperatures. The device and cradle indicates when charging is disabled due to abnormal temperatures via its LED.

2-Slot USB/Ethernet Cradle



CAUTION: Ensure that you follow the guidelines for battery safety described in Battery Safety Guidelines on page 203.

The 2-Slot USB/Ethernet Cradle:

- Provides 5.0 VDC power for operating the device.
- Charges the device's battery.
- Charges a spare battery.
- Connects the device to an Ethernet network.
- Provides communication to a host computer using a USB cable.



NOTE: Remove all attachments on the device, except the hand strap, before place onto the cradle.

Figure 139 2-Slot USB/Ethernet Cradle

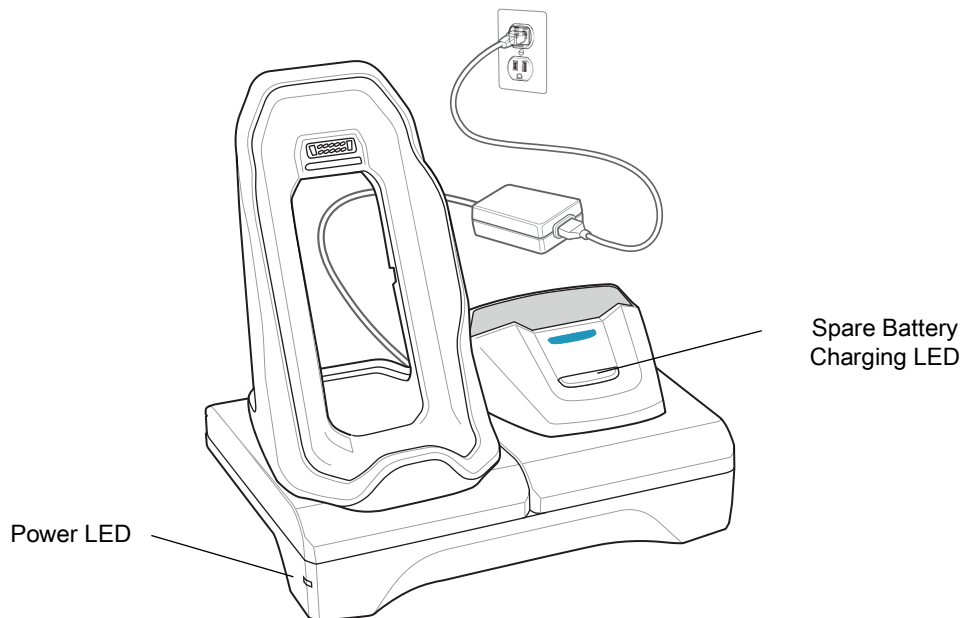

Charging the Device

1. Place the bottom of the device into the base.

Figure 140 Battery Charging

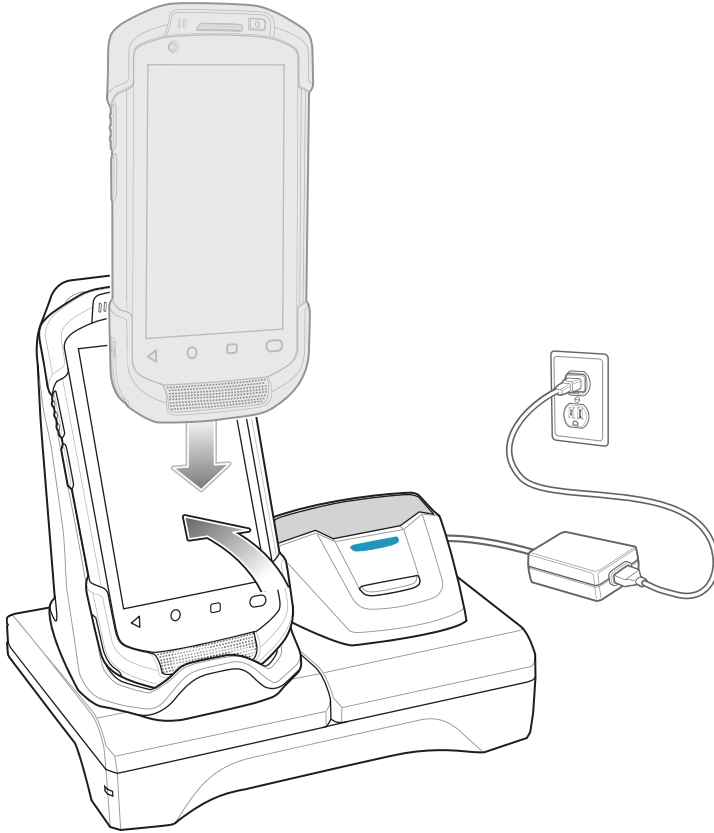

2. Rotate the top of the device until the connector on the back of the device mates with the connector on the cradle.
3. Ensure the device is connected properly. The charging Charging/Notification LED on the device begins blinking amber indicating that the device is charging.

Charging the Spare Battery

1. Insert the battery into the right slot to begin charging.

Figure 141 Spare Battery Charging

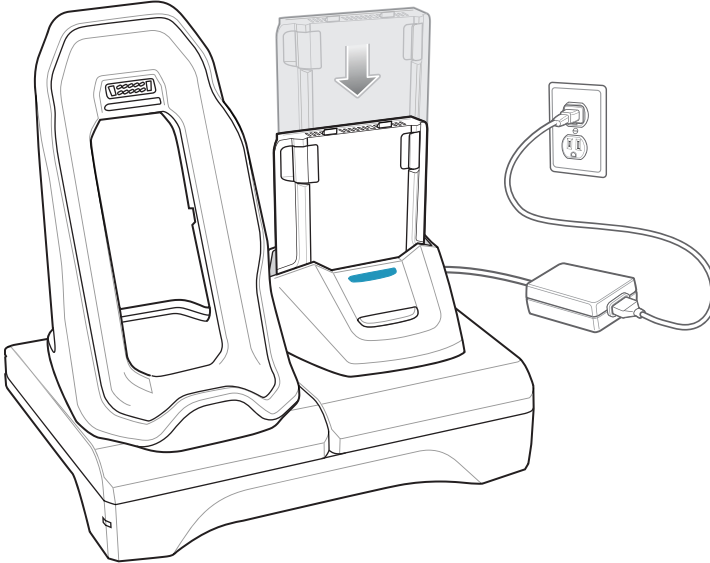

2. Ensure the battery is seated properly.

Battery Charging

Main Battery Charging

The device's Charging/Notification LED indicates the status of the battery charging in the device.

The 4620 mAh battery fully charges in less than five hours at room temperature.

Spare Battery Charging

The Spare battery Charging LED on the cup indicates the status of the spare battery charging.

The 4620 mAh battery fully charges in less than five hours at room temperature.

Table 16 Spare Battery Charging LED Indicators

LED	Indication
Slow Blinking Amber	Spare battery is charging.
Solid Green	Charging complete.
Fast Blinking Amber	Error in charging; check placement of spare battery.
Slow Blinking Red	Spare battery is charging and battery is at the end of useful life.

Table 16 Spare Battery Charging LED Indicators (Continued)

LED	Indication
Solid Red	Charging complete and battery is at the end of useful life.
Fast Blinking Red	Error in charging; check placement of spare battery and battery is at the end of useful life.
Off	No spare battery in slot; spare battery not placed correctly; cradle is not powered.

Charging Temperature

Charge batteries in temperatures from 0°C to 40°C (32°F to 104°F). The device or cradle always performs battery charging in a safe and intelligent manner. At higher temperatures (e.g. approximately +37°C (+98°F)) the device or cradle may for small periods of time alternately enable and disable battery charging to keep the battery at acceptable temperatures. The device and cradle indicates when charging is disabled due to abnormal temperatures via its LED.

USB/Ethernet Communication

The 2–Slot USB/Ethernet Cradle provides both Ethernet communication with a network and USB communication with a host computer. Prior to using the cradle for Ethernet or USB communication. Ensure that the switch on the USB/Ethernet module is set properly.

Turn the cradle over to view the module.

Figure 142 2–Slot USB/Ethernet Cradle Module Switch

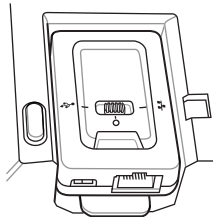

For Ethernet communication, slide the switch to the  position.

For USB communication, slide the switch to the  position.

Place the switch in the center position  to disable communications.

Ethernet LED Indicators

There are two LEDs on the USB/Ethernet Module RJ-45 connector. The green LED lights to indicate that the transfer rate is 100 Mbps. When the LED is not lit the transfer rate is 10 Mbps. The yellow LED blinks to indicate activity, or stays lit to indicate that a link is established. When it is not lit it indicates that there is no link.

Figure 143 LED Indicators

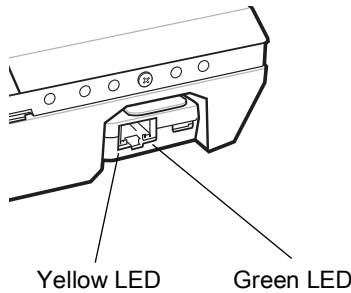





Table 17 USB/Ethernet Module LED Data Rate Indicators

Data Rate	Yellow LED	Green LED
100 Mbps	On/Blink	On
10 Mbps	On/Blink	Off

Establishing Ethernet Connection



NOTE: Refer to the device Integrator Guide for Android Version 8.1 for information on configuring the Ethernet settings.

1. Swipe down with two fingers from the status bar to open the quick access panel and then touch .
2. Touch  **Ethernet**.
3. Slide the Ethernet switch to the **ON** position.
4. Insert the device into a slot.
The  icon appears in the Status bar.
5. Touch **Eth0** to view Ethernet connection details.

5-Slot Charge Only Cradle



CAUTION: Ensure that you follow the guidelines for battery safety described in Battery Safety Guidelines on page 203.

The 5-Slot Charge Only Cradle:

- Provides 5 VDC power for operating the device.
- Simultaneously charges up to five devices and up to four devices and one 4-Slot Battery Charger using the Battery Charger Adapter. See the device Integrator Guide for Android Version 8.1 for information on installing the 4-Slot Battery Charger onto the cradle.

- Consists of a cradle base and cups that can be configured for various charging requirements.

Figure 144 5-Slot Charge Only Cradle

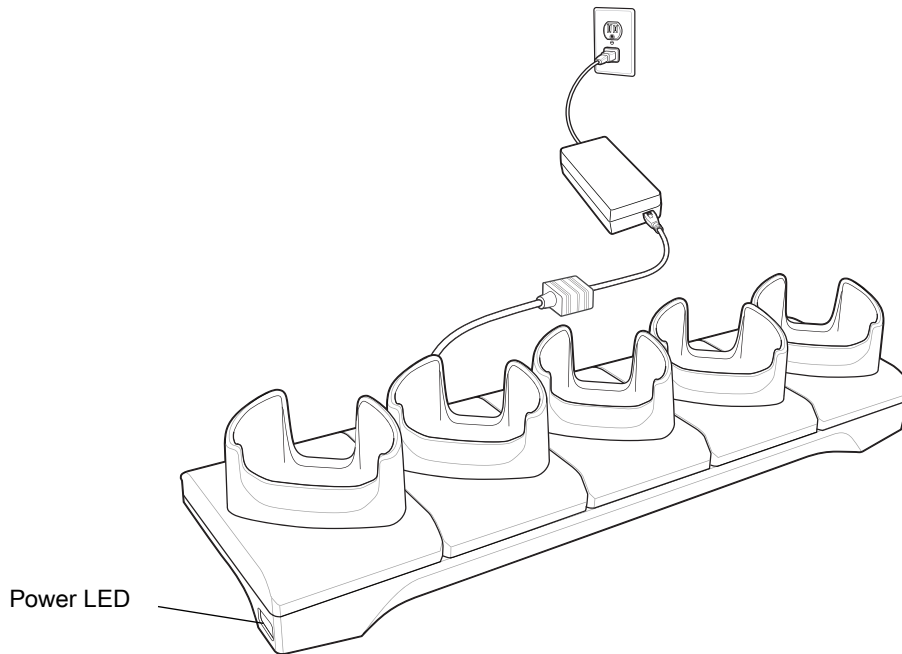

Charging the TC75

1. Insert the device into a slot to begin charging.

Figure 145 Battery Charging

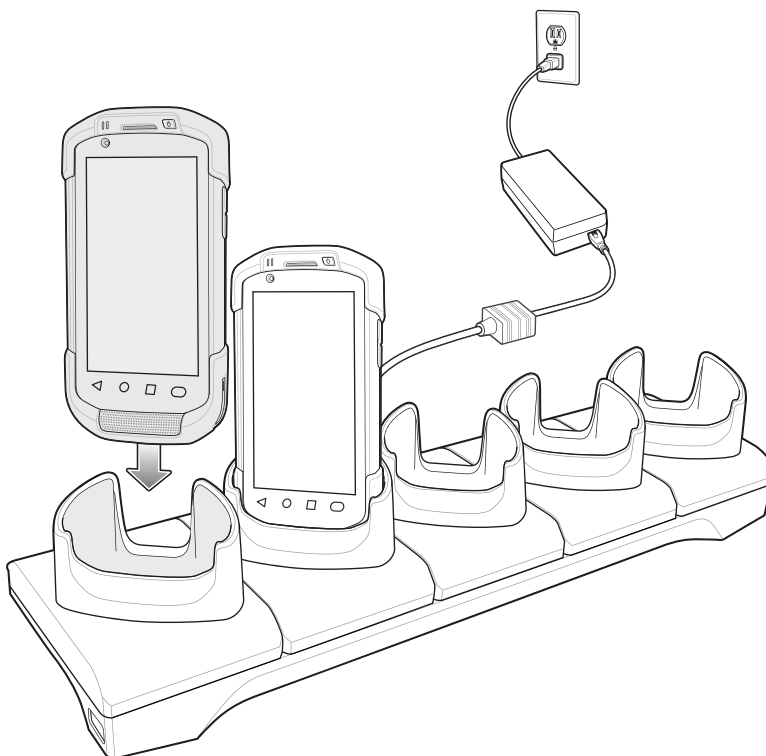

2. Ensure the device is seated properly.



NOTE: See the device Integrator Guide for Android Version 8.1 for information on installing the 4-Slot Battery Charger onto the cradle.

Battery Charging

Main Battery Charging

The device's Charging/Notification LED indicates the status of the battery charging in the device.

The 4620 mAh battery fully charges in less than five hours at room temperature.

Spare Battery Charging

The Spare battery Charging LED on the cup indicates the status of the spare battery charging.

The 4620 mAh battery fully charges in less than five hours at room temperature.

Table 18 Spare Battery Charging LED Indicators

LED	Indication
Slow Blinking Amber	Spare battery is charging.
Solid Green	Charging complete.
Fast Blinking Amber	Error in charging; check placement of spare battery.
Slow Blinking Red	Spare battery is charging and battery is at the end of useful life.
Solid Red	Charging complete and battery is at the end of useful life.
Fast Blinking Red	Error in charging; check placement of spare battery and battery is at the end of useful life.
Off	No spare battery in slot; spare battery not placed correctly; cradle is not powered.

Charging Temperature

Charge batteries in temperatures from 0°C to 40°C (32°F to 104°F). The device or cradle always performs battery charging in a safe and intelligent manner. At higher temperatures (e.g. approximately +37°C (+98°F)) the device or cradle may for small periods of time alternately enable and disable battery charging to keep the battery at acceptable temperatures. The device and cradle indicates when charging is disabled due to abnormal temperatures via its LED.

4-Slot Charge Only Cradle with Battery Charger



CAUTION: Ensure that you follow the guidelines for battery safety described in Battery Safety Guidelines on page 203.

The 4-Slot Charge Only Cradle with Battery Charger:

- Provides 5 VDC power for operating the TC70x.

- Simultaneously charges up to four devices and up to four spare batteries.

Figure 146 4-Slot Charge Only Cradle with Battery Charger

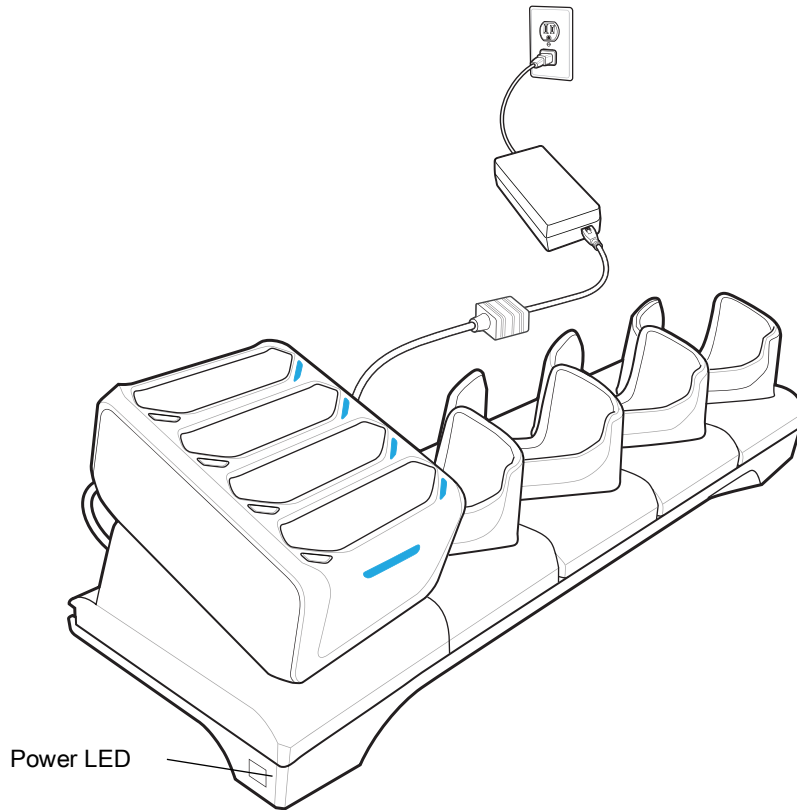

Charging the Device

1. Insert the device into a slot to begin charging.

Figure 147 Battery Charging

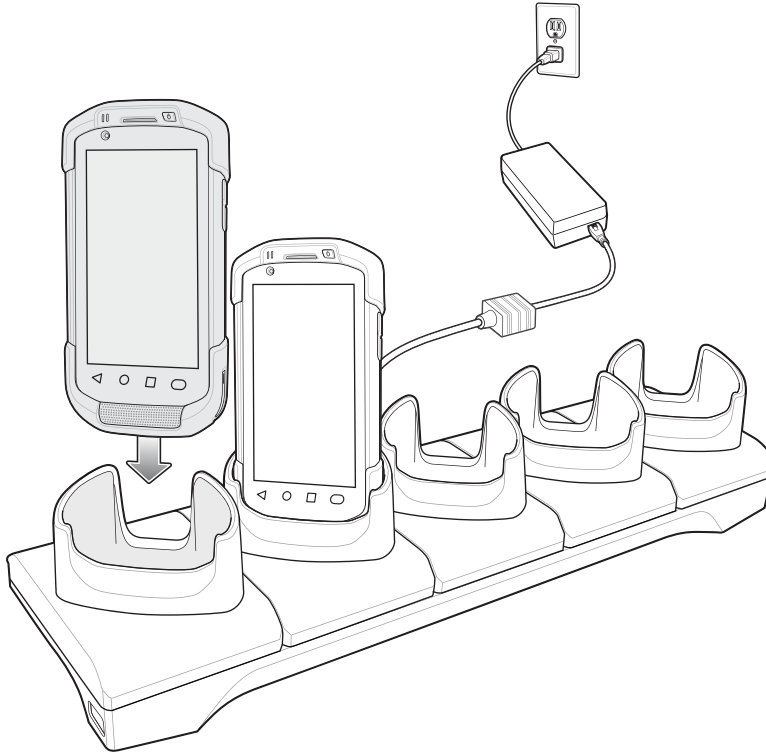

2. Ensure the device is seated properly.



NOTE: See the device Integrator Guide for Android Version 8.1 for information on installing the 4-Slot Battery Charger onto the cradle.

Battery Charging

Main Battery Charging

The device's Charging/Notification LED indicates the status of the battery charging in the device.

The 4620 mAh battery fully charges in less than five hours at room temperature.

Spare Battery Charging

The Spare battery Charging LED on the cup indicates the status of the spare battery charging.

The 4620 mAh battery fully charges in less than five hours at room temperature.

Table 19 Spare Battery Charging LED Indicators

LED	Indication
Slow Blinking Amber	Spare battery is charging.
Solid Green	Charging complete.
Fast Blinking Amber	Error in charging; check placement of spare battery.
Slow Blinking Red	Spare battery is charging and battery is at the end of useful life.
Solid Red	Charging complete and battery is at the end of useful life.
Fast Blinking Red	Error in charging; check placement of spare battery and battery is at the end of useful life.
Off	No spare battery in slot; spare battery not placed correctly; cradle is not powered.

Charging Temperature

Charge batteries in temperatures from 0°C to 40°C (32°F to 104°F). The device or cradle always performs battery charging in a safe and intelligent manner. At higher temperatures (e.g. approximately +37°C (+98°F)) the device or cradle may for small periods of time alternately enable and disable battery charging to keep the battery at acceptable temperatures. The device and cradle indicates when charging is disabled due to abnormal temperatures via its LED.

5-Slot Ethernet Cradle



CAUTION: Ensure that you follow the guidelines for battery safety described in Battery Safety Guidelines on page 203.

The 5-Slot Ethernet Cradle:

- Provides 5.0 VDC power for operating the device.
- Connects the device (up to five) to an Ethernet network.

- Simultaneously charges up to five devices and up to four devices and on 4-Slot Battery Charger using the Battery Charger Adapter. See the device Integrator Guide for Android Version 8.1 for information on installing the 4-Slot Battery Charger onto the cradle.

Figure 148 5-Slot Ethernet Cradle

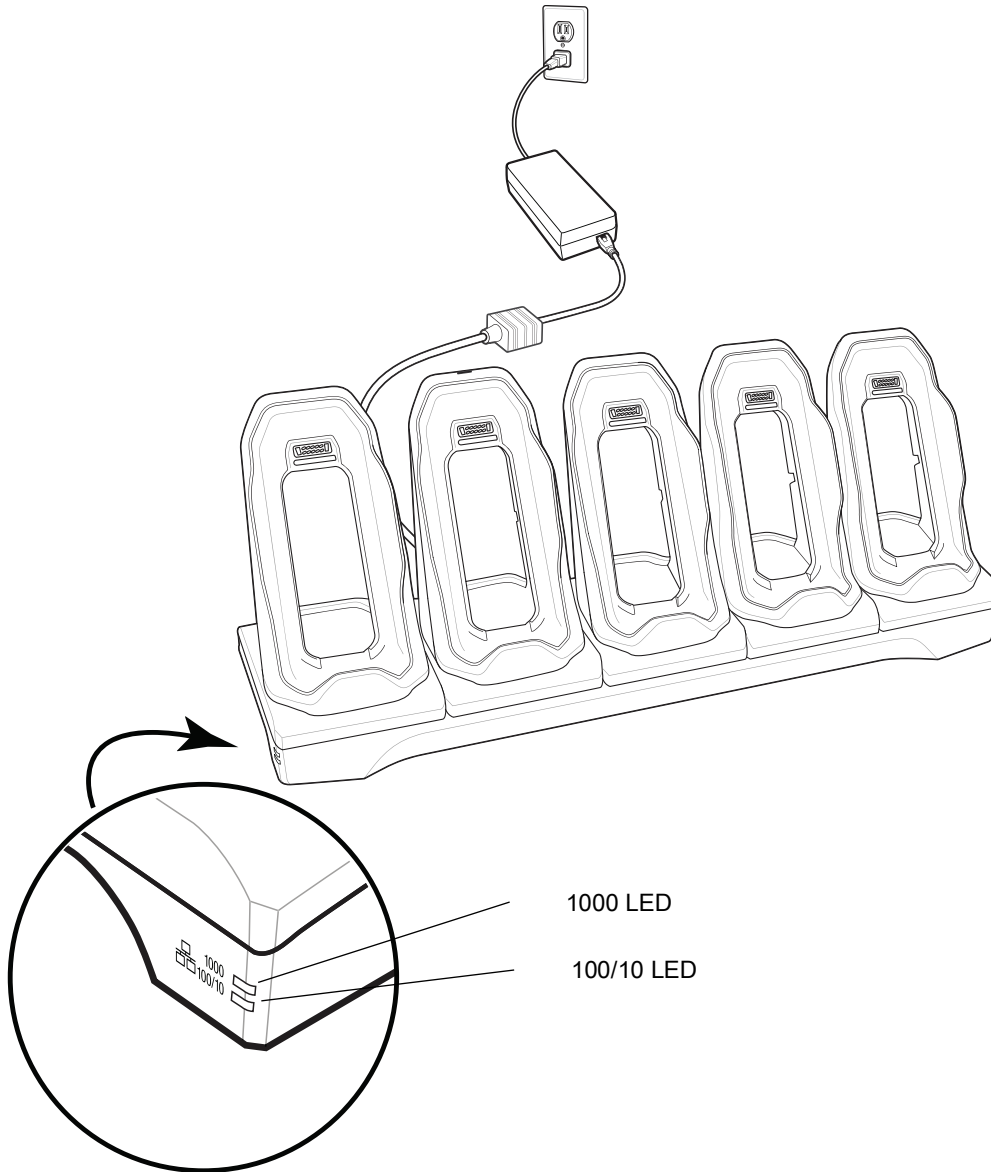

Charging the Device

1. Insert the device into a slot to begin charging.

Figure 149 Battery Charging

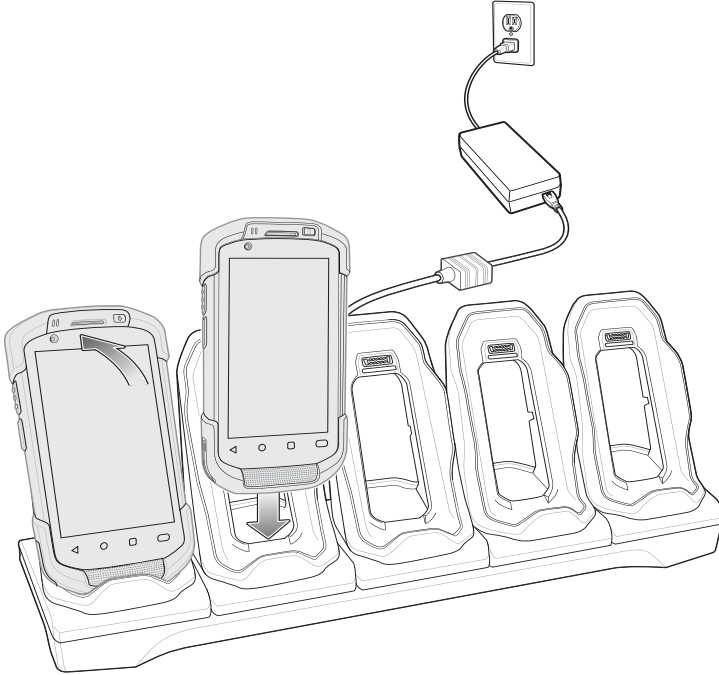

2. Ensure the device is seated properly.

Figure 150 5-Slot Ethernet Cradle with 4-Slot Battery Charger

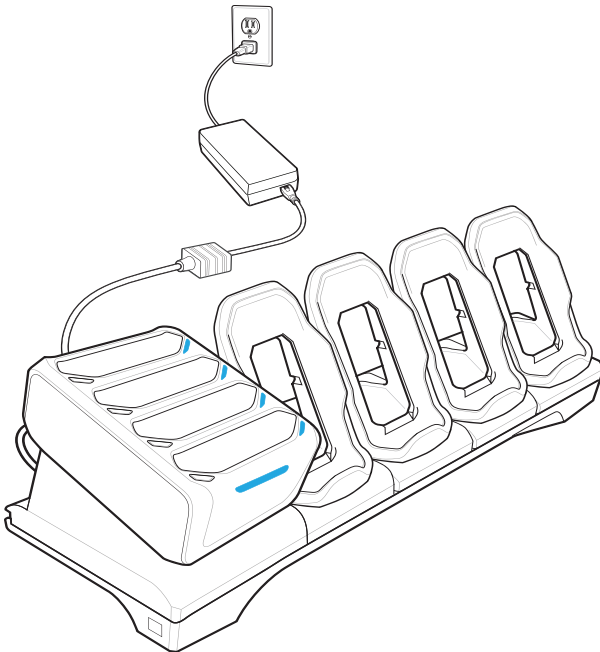

NOTE: See the device Integrator Guide for Android Version 8.1 for information on installing the 4-Slot Battery Charger onto the cradle.

Battery Charging

Main Battery Charging

The device's Charging/Notification LED indicates the status of the battery charging in the device.

The 4620 mAh battery fully charges in less than five hours at room temperature.

Spare Battery Charging

The Spare battery Charging LED on the cup indicates the status of the spare battery charging.

The 4620 mAh battery fully charges in less than five hours at room temperature.

Table 20 Spare Battery Charging LED Indicators

LED	Indication
Slow Blinking Amber	Spare battery is charging.
Solid Green	Charging complete.
Fast Blinking Amber	Error in charging; check placement of spare battery.
Slow Blinking Red	Spare battery is charging and battery is at the end of useful life.
Solid Red	Charging complete and battery is at the end of useful life.
Fast Blinking Red	Error in charging; check placement of spare battery and battery is at the end of useful life.
Off	No spare battery in slot; spare battery not placed correctly; cradle is not powered.



Charging Temperature

Charge batteries in temperatures from 0°C to 40°C (32°F to 104°F). The device or cradle always performs battery charging in a safe and intelligent manner. At higher temperatures (e.g. approximately +37°C (+98°F)) the device or cradle may for small periods of time alternately enable and disable battery charging to keep the battery at acceptable temperatures. The device and cradle indicates when charging is disabled due to abnormal temperatures via its LED.

Establishing Ethernet Connection



NOTE: Refer to the device Integrator Guide for Android Version 8.1 for information on configuring the Ethernet settings.

1. Swipe down with two fingers from the status bar to open the quick access panel and then touch .
2. Touch **Ethernet**.
3. Slide the Ethernet switch to the **ON** position.
4. Insert the device into a slot.
The  icon appears in the Status bar.
5. Touch **Eth0** to view Ethernet connection details.

LED Indicators

There are two green LEDs on the side of the cradle. These green LEDs light and blink to indicate the data transfer rate.

Table 21 LED Data Rate Indicators

Data Rate	1000 LED	100/10 LED
1 Gbps	On/Blink	Off
100 Mbps	Off	On/Blink
10 Mbps	Off	On/Blink

4-Slot Battery Charger



CAUTION: Ensure that you follow the guidelines for battery safety described in Battery Safety Guidelines on page 203.

This section describes how to use the 4-Slot Battery Charger to charge up to four device batteries.

Charging Spare Batteries

1. Connect the charger to a power source.
2. Insert the battery into a battery charging well and gently press down on the battery to ensure proper contact.

Figure 151 4-Slot Battery Charger

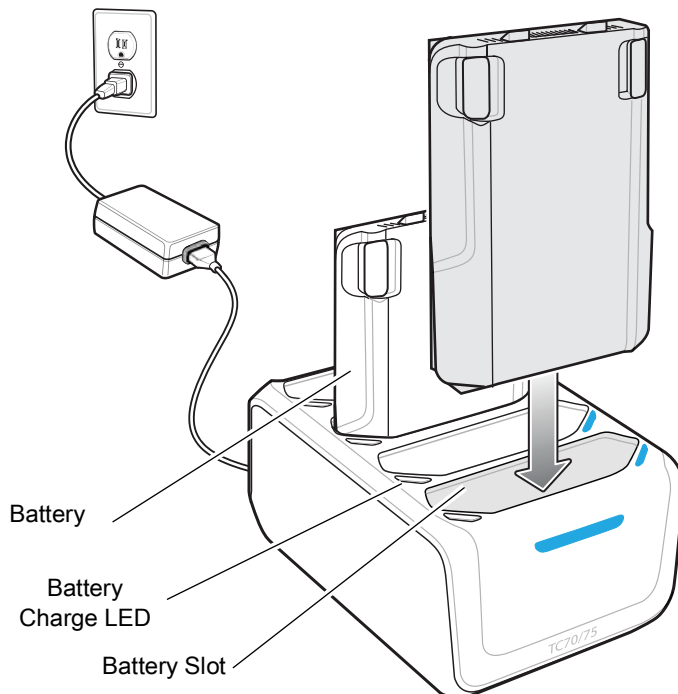

Battery Charging

Spare Battery Charging

Each Battery Charging LED indicates the status of the battery charging in each slot. The table below describes the Battery Charging LED status.

The 4620 mAh battery fully charges in less than five hours at room temperature.

Table 22 Battery LED Charging Indicators

LED	Indication
Slow Blinking Amber	Spare battery is charging.
Solid Green	Charging complete.
Fast Blinking Amber	Error in charging; check placement of spare battery.
Slow Blinking Red	Spare battery is charging and battery is at the end of useful life.
Solid Red	Charging complete and battery is at the end of useful life.
Fast Blinking Red	Error in charging; check placement of spare battery and battery is at the end of useful life.
Off	No spare battery in slot; spare battery not placed correctly; cradle is not powered.

Charging Temperature

Charge batteries in temperatures from 0°C to 40°C (32°F to 104°F). The battery charger always performs battery charging in a safe and intelligent manner. At higher temperatures (e.g. approximately +37°C (+98°F)) the battery charger may for small periods of time alternately enable and disable battery charging to keep the battery at acceptable temperatures. The battery charger indicates when charging is disabled due to abnormal temperatures via its LED.

3.5 mm Audio Adapter

The 3.5 mm Audio Adapter snaps onto the back of the device and removes easily when not in use. When attached to the device the 3.5 mm Audio Adapter allows a user to connect a wired headset to the device.

Connecting a Headset to the 3.5 mm Audio Adapter

1. Connect the Quick Disconnect connect of the headset to the Quick Disconnect connector of the 3.5 mm Quick Disconnect Adapter Cable.

Figure 152 Connect Headset to Adapter Cable

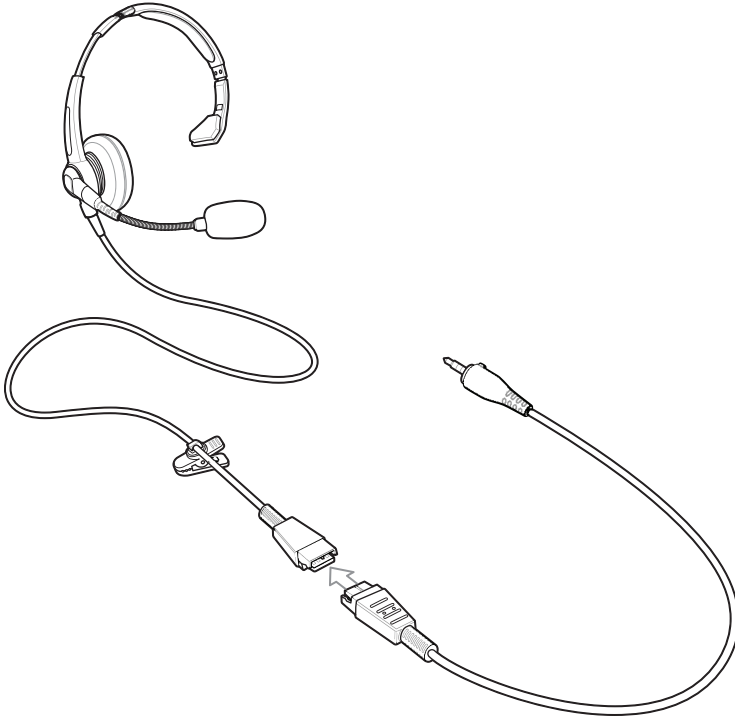

2. Connect the audio jack of the 3.5 mm Quick Disconnect Adapter Cable to the 3.5 mm Audio Adapter.

Figure 153 Connect Adapter Cable to Audio Adapter

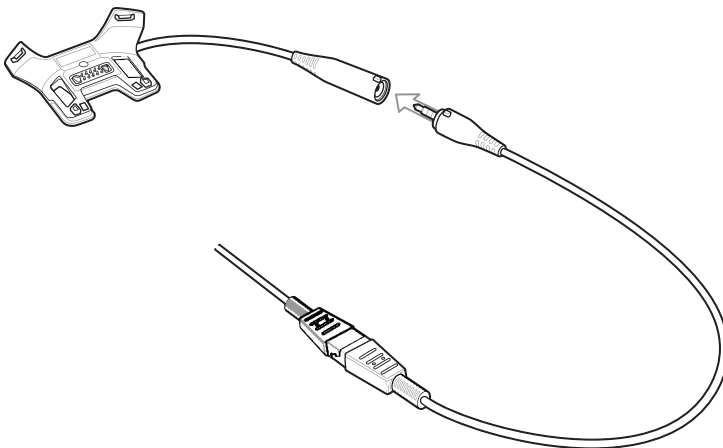

Attaching the 3.5 mm Audio Adapter

1. Align the top mounting points on the 3.5 mm Audio Adapter with the mounting slots on the device.

Figure 154 Audio Adapter Installation

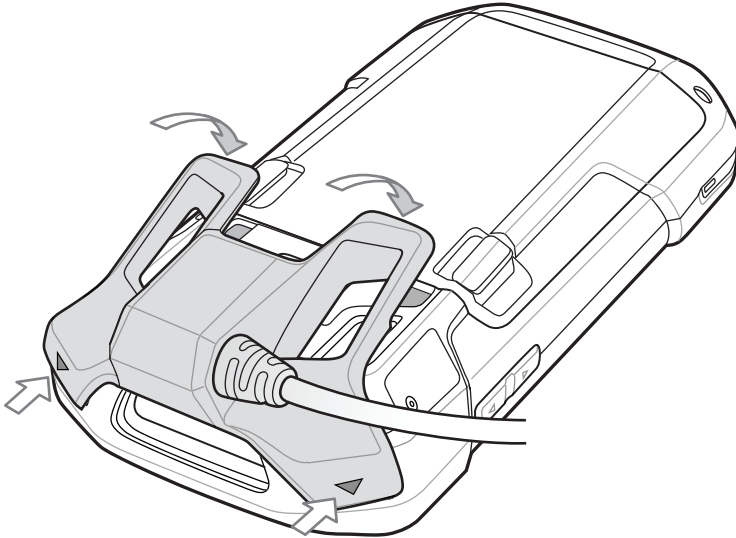

2. Rotate the Audio Adapter down and press down until it snaps into position.

Device with 3.5 mm Audio Adapter in Holster

When using the device and the audio adapter in a holster, ensure that the display faces in and the headset cable is securely attached to the audio adapter.

Figure 155 Device with 3.5 mm Audio Adapter in Holster

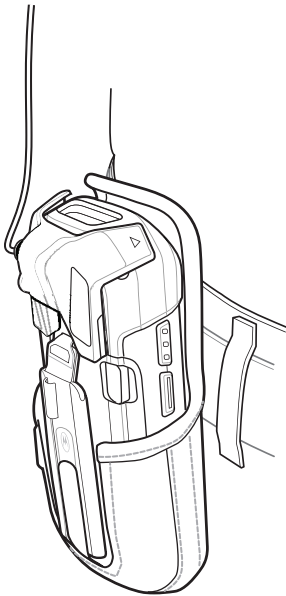

Removing the 3.5 mm Audio Adapter

1. Disconnect headset plug from 3.5 mm Audio Adapter.
2. Lift the bottom of the Audio Adapter away from the device.

Figure 156 Remove Audio Adapter from Device

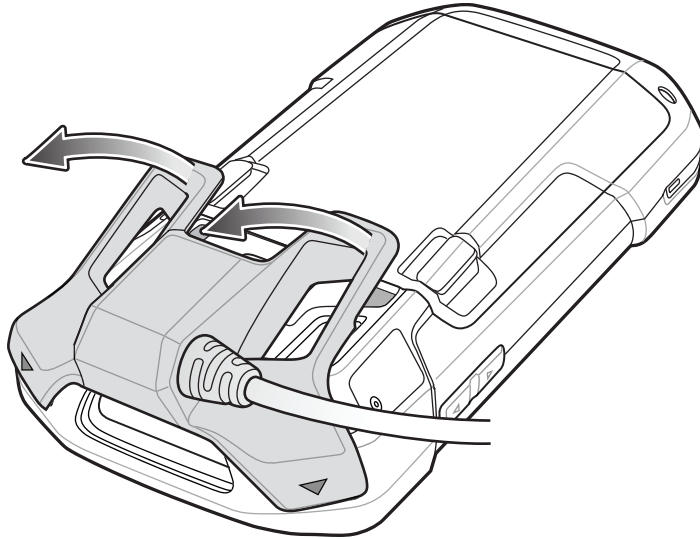

3. Remove Audio Adapter from the device.

Rigid Holster

Use the rigid holster to securely hold the device on a belt for easy access.

Installing the TC7X into the Rigid Holster

1. Align the device with the image on the holster.

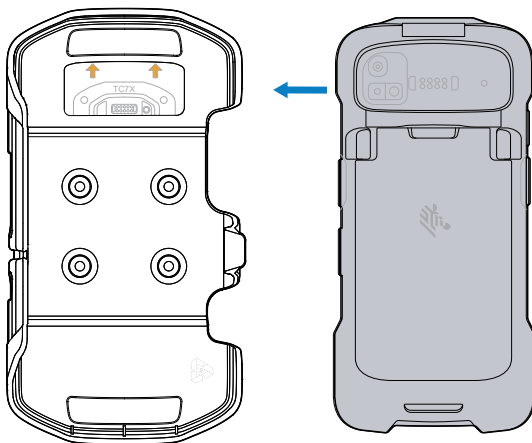

2. Insert the TC7X into the rigid holster with the scanner pointing upwards.

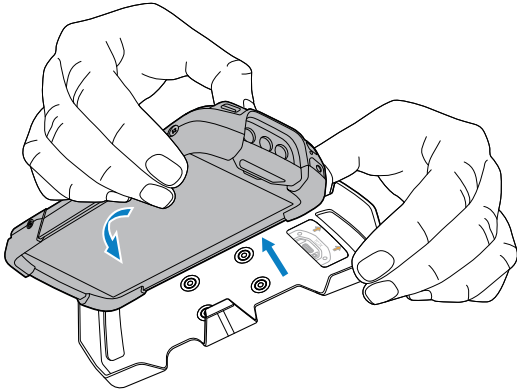

3. Push the TC7X face down into the holster until it securely snaps in place.

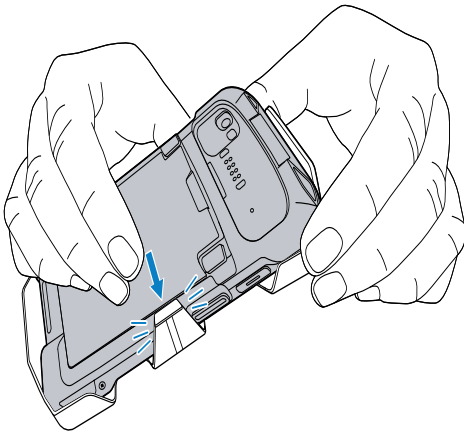

Removing the TC7X from the Rigid Holster

To remove the TC7X from the rigid holster, use your thumb to press the clip outward.

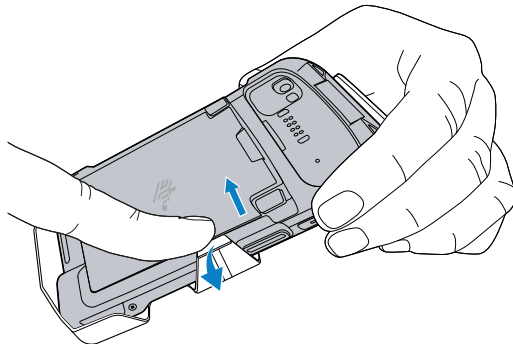

Snap-On USB Cable

The Snap-On USB Cable snaps on to the back of the device and removes easily when not in use. When attached to the device the Snap-On USB Cable allows the device to transfer data to a host computer and provide power for charging the device.

Connecting to Device

1. Align the top mounting points on the cable with the mounting slots on the device.

Figure 157 Cable Installation

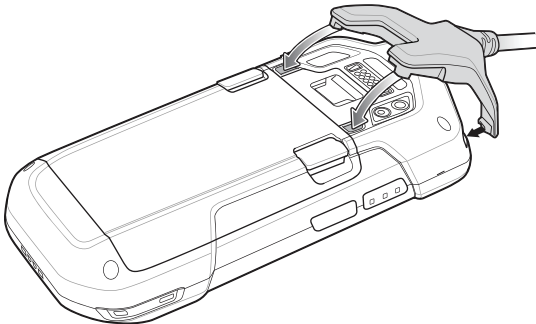

2. Rotate the cable down and press until it snaps into place. Magnetics hold the cable to the device.

Figure 158 Cable Attached to TC75

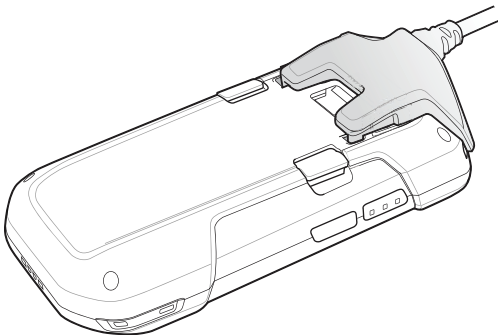

USB Communication

1. Connect the Snap-On USB Cable to the device.

Figure 159 Cable Removed from Device

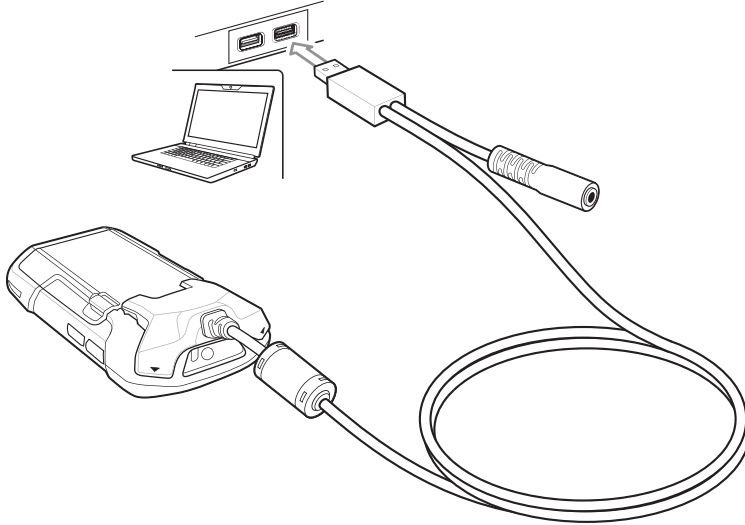

2. Connect the USB connector of the cable to a host computer.

Charging the Device

1. Connect the Snap-On USB Cable to the device.
2. Connect the power supply to the Snap-On USB Cable

Figure 160 Power Setup

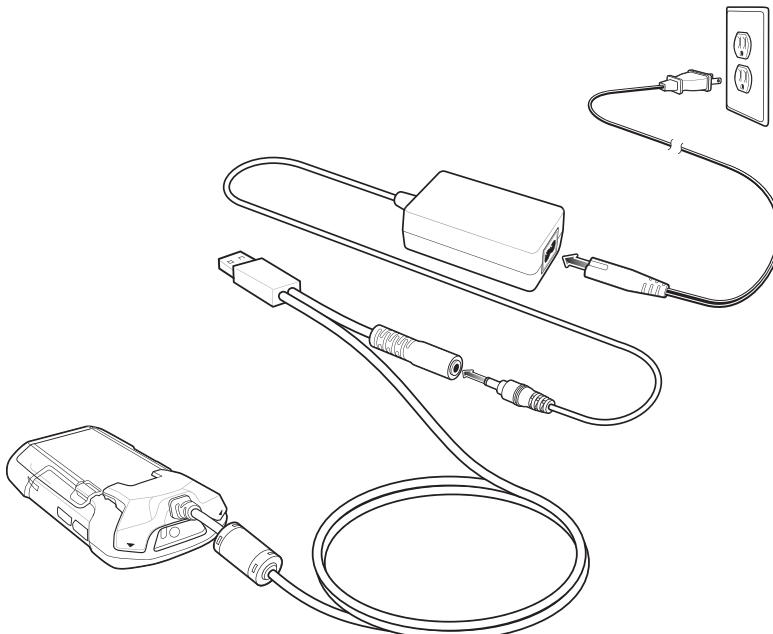

3. Connect to the power supply to an AC outlet.

Disconnecting from Device

1. Press down on the cable.

Figure 161 Press Down on Cable

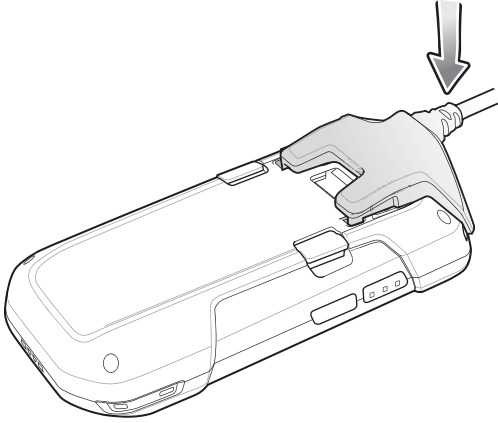

2. Rotate away from the device. The magnetics release the cable from the device.

Figure 162 Remove Cable from Device

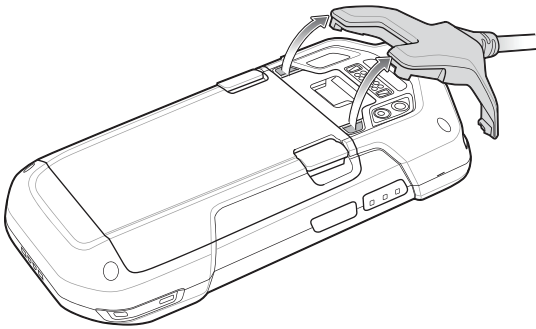

Battery Charging

Main Battery Charging

The device's Charging/Notification LED indicates the status of the battery charging in the device.

The 4620 mAh battery fully charges in less than five hours at room temperature.

Charging Temperature

Charge batteries in temperatures from 0°C to 40°C (32°F to 104°F). The device always performs battery charging in a safe and intelligent manner. At higher temperatures (e.g. approximately +37°C (+98°F)) the device may for small periods of time alternately enable and disable battery charging to keep the battery at acceptable temperatures. The device indicates when charging is disabled due to abnormal temperatures via its LED.

Charging Cable Cup

This section describes how to use the Charging Cable Cup to charge the device.

Charging the Device

1. Insert the device into the cup of the Charging Cable Cup.

Figure 163 Charging

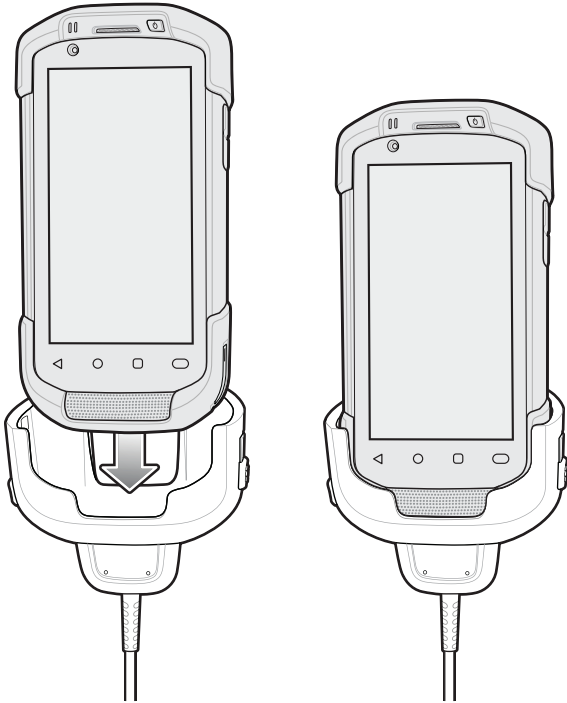

2. Ensure the device is seated properly.
3. Slide the two yellow locking tabs up to lock the cable to the device.

Figure 164 Lock Cable Cup

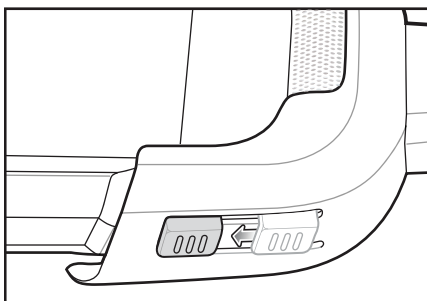

4. Connect the power supply to the Charging Cable Cup and to a power source.

Figure 165 Connect Cable to Power Supply

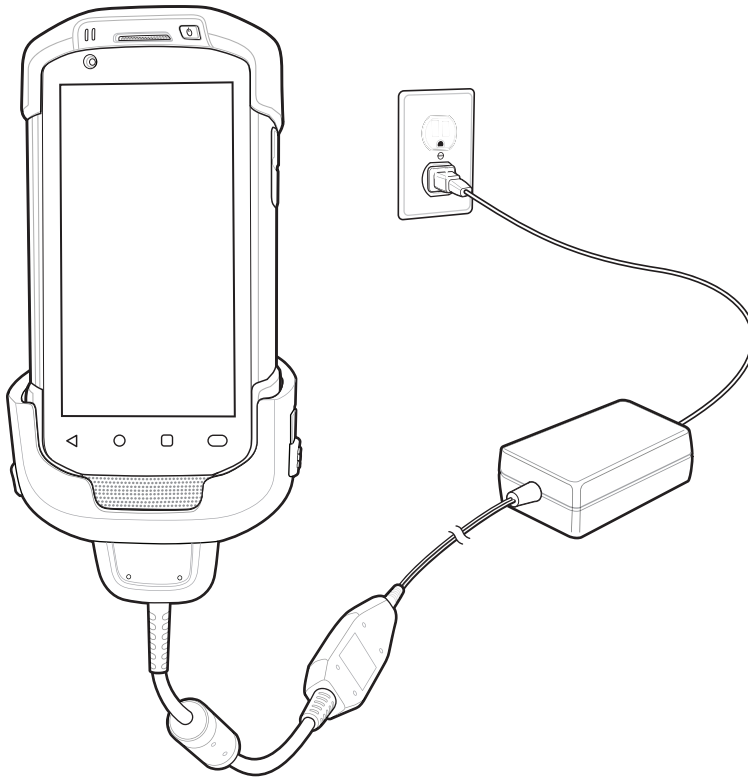

Battery Charging

Main Battery Charging

The device's Charging/Notification LED indicates the status of the battery charging in the device.

The 4620 mAh battery fully charges in less than five hours at room temperature.

Charging Temperature

Charge batteries in temperatures from 0°C to 40°C (32°F to 104°F). The device always performs battery charging in a safe and intelligent manner. At higher temperatures (e.g. approximately +37°C (+98°F)) the device may for small periods of time alternately enable and disable battery charging to keep the battery at acceptable temperatures. The device indicates when charging is disabled due to abnormal temperatures via its LED.

Snap-On DEX Cable

The Snap-On DEX Cable snaps on to the back of the device and removes easily when not in use. When attached to the device the Snap-On DEX Cable provides electronic data exchange with devices such as vending machines.

Connecting to Device

1. Align the top mounting points on the cable with the mounting slots on the device.

Figure 166 Cable Installation

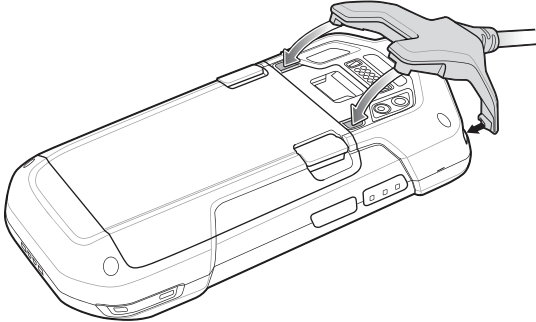

2. Rotate the cable down and press until it snaps into place. Magnetics hold the cable to the device.

Figure 167 Cable Attached to Device

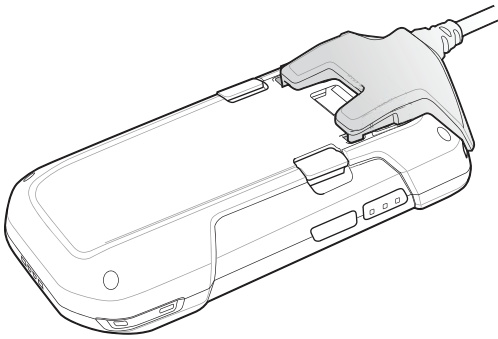

DEX Communication

1. Connect the Snap-On DEX Cable to the device.

2. Connect the DEX connector of the cable to a device such as a vending machine.

Figure 168 DEX Cable Connection

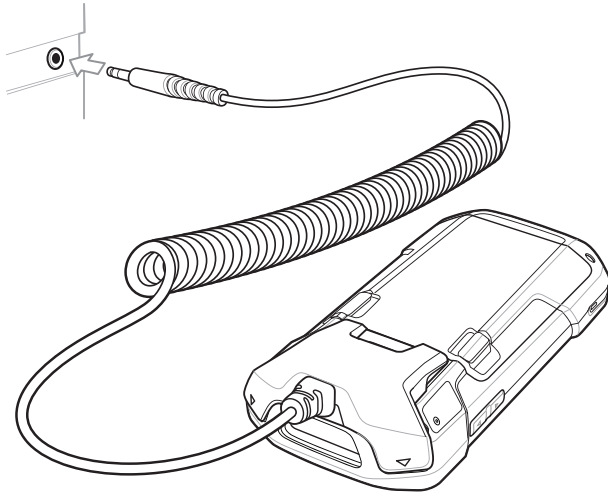

Disconnecting from Device

1. Press down on the cable.

Figure 169 Press Down on Cable

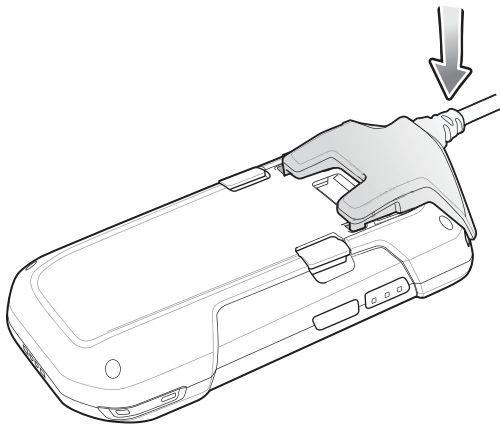

2. Rotate away from the device. The magnetics release the cable from the device.

Figure 170 Remove Cable from Device

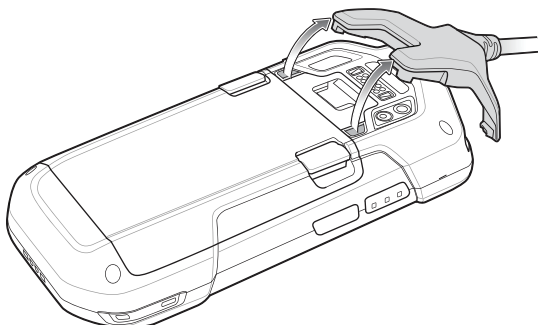

Trigger Handle

The Trigger Handle adds a gun-style handle with a scanning trigger to the device. It increases comfort when using the device in scan-intensive applications for extended periods of time.

Figure 171 Trigger Handle

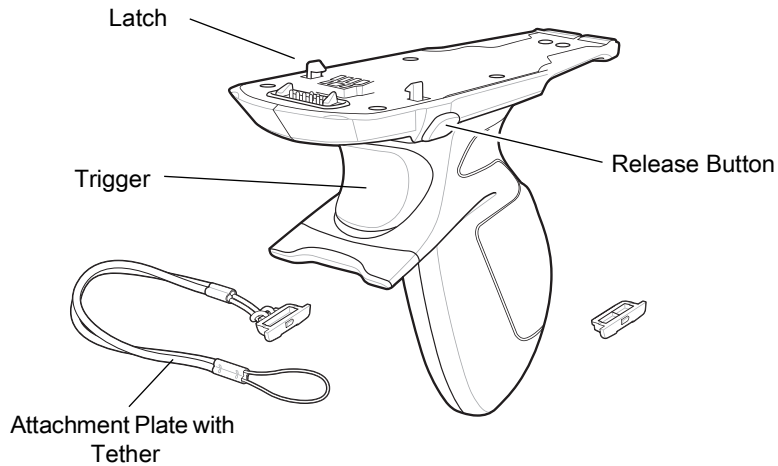

Installing the Attachment Plate to Trigger Handle

To install the attachment plate to the Trigger Handle:

1. Insert the loop end of the tether into the slot on the bottom of the handle.
2. Feed the attachment plate through the loop.

Figure 172 Install Attachment Plate to Handle

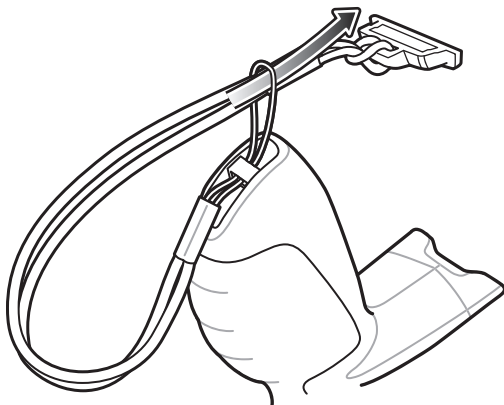

3. Pull the attachment plate until the loop tightens on the tether.

Installing the Trigger Handle Plate

1. Press and hold the **Power** button until the menu appears.

2. Touch **Power off**.
3. Touch **OK**.
4. Press in the two battery latches.
5. Lift the battery from the device.
6. Remove the hand strap filler plate from the hand strap slot. Store the hand strap filler plate in a safe place for future replacement.

Figure 173 Remove Hand Strap Plate

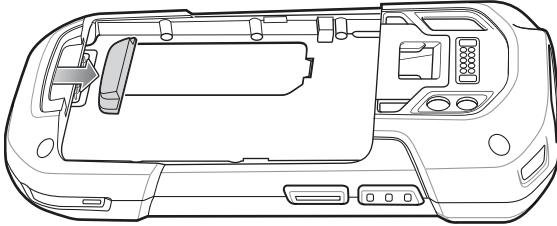

7. Insert the attachment plate into the hand strap slot.

Figure 174 Insert Trigger Handle Plate

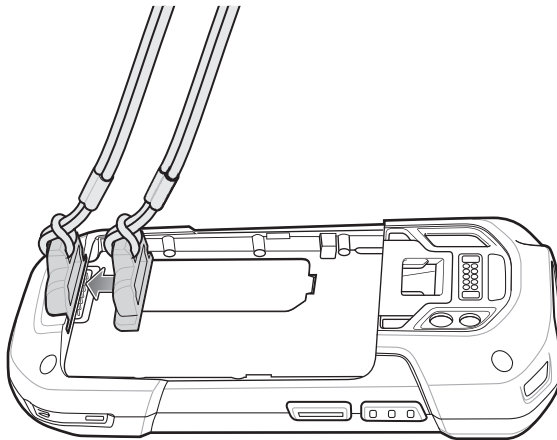

8. Insert the battery, bottom first, into the battery compartment in the back of the device.
9. Rotate the top of the battery into the battery compartment.
10. Press the battery down into the battery compartment until the battery release latches snap into place.

Inserting the Device into the Trigger Handle

1. Align the back of the Trigger handle with the Trigger Mounting Plate.

Figure 175 Connect Device to Trigger Handle

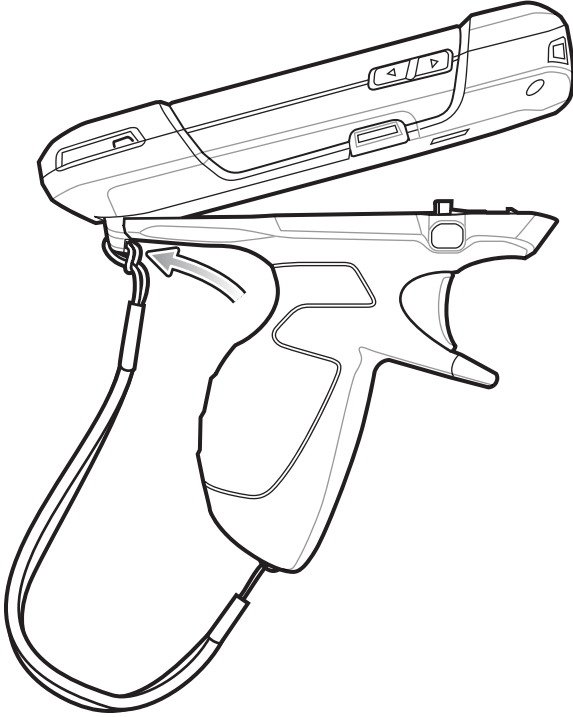

2. Press the two release latches.

3. Rotate the device down and press down until it snaps into place.

Figure 176 Rotate Device onto Trigger Handle



Removing the Device from the Trigger Handle

1. Press both Trigger Handle release latches.

Figure 177 Press Release Latches

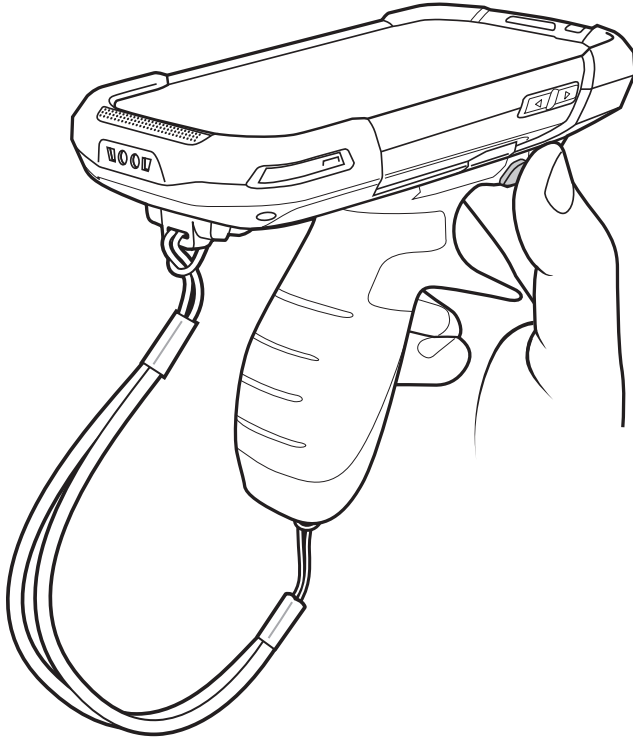

2. Rotate the device up and remove from the Trigger handle.

3. Rotate the device down and press down until it snaps into place.

Figure 178 Rotate Device onto Trigger Handle

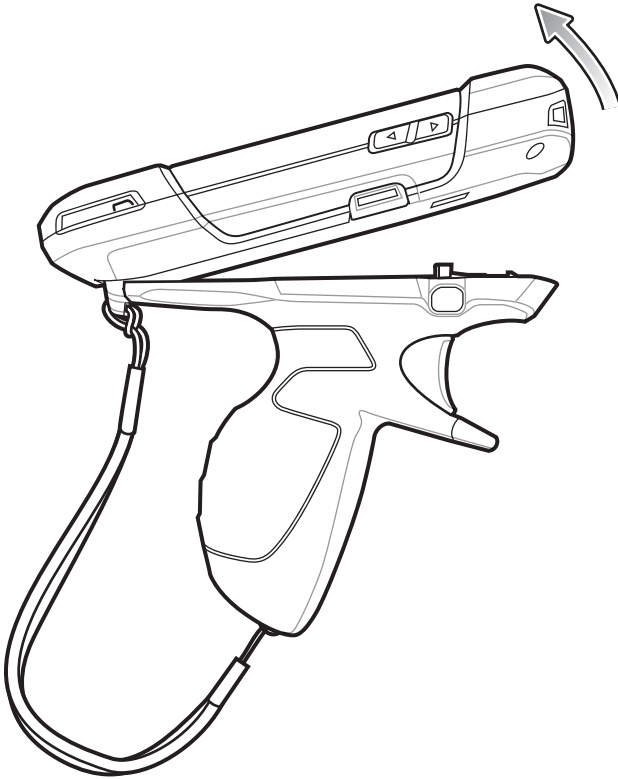

Vehicle Charging Cable Cup

This section describes how to use the Vehicle Charging Cable Cup to charge the device.

Figure 179 Vehicle Charging Cable Cup

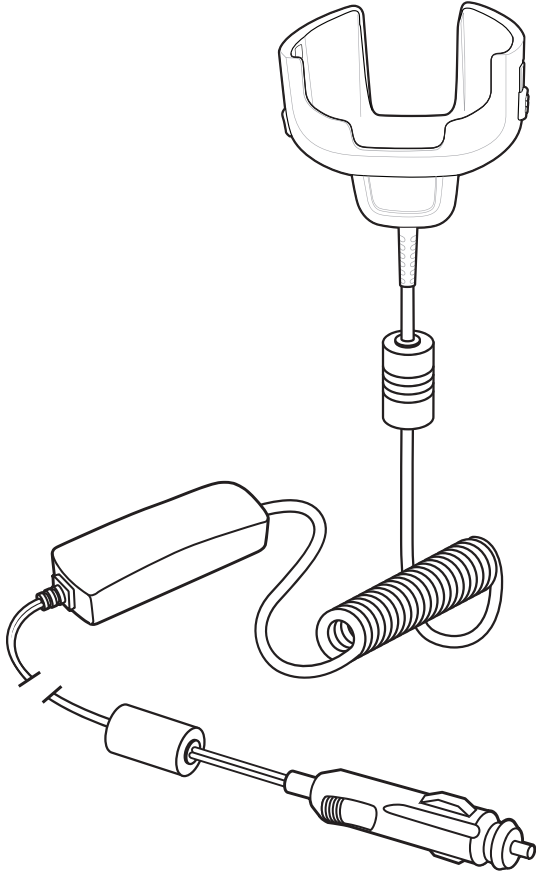

Charging the Device

1. Insert the device into the cup of the Vehicle Charging Cable.

Figure 180 Charging

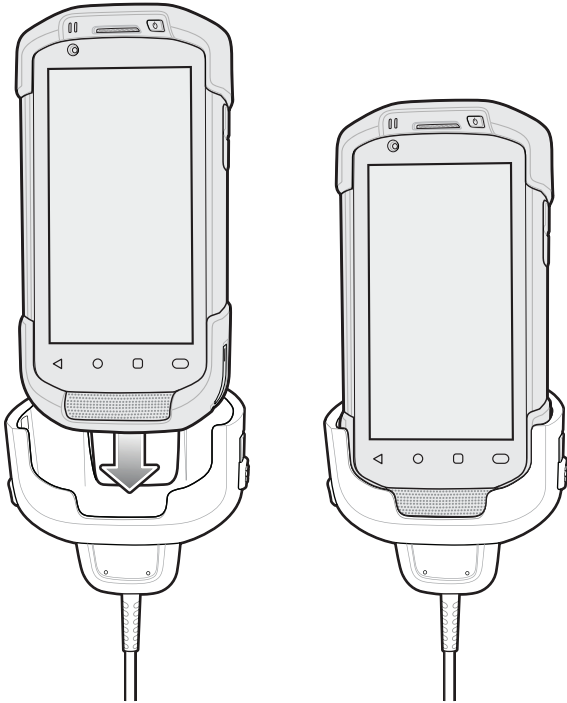

2. Ensure the device is seated properly.
3. Slide the two yellow locking tabs up to lock the cable to the device.

Figure 181 Lock Cable Cup

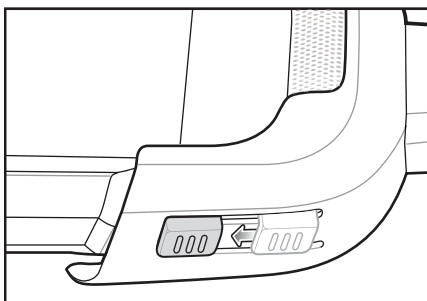

4. Insert the Cigarette Lighter plug into the vehicle cigarette lighter socket.

Figure 182 Connect Cable to Vehicle Power Source

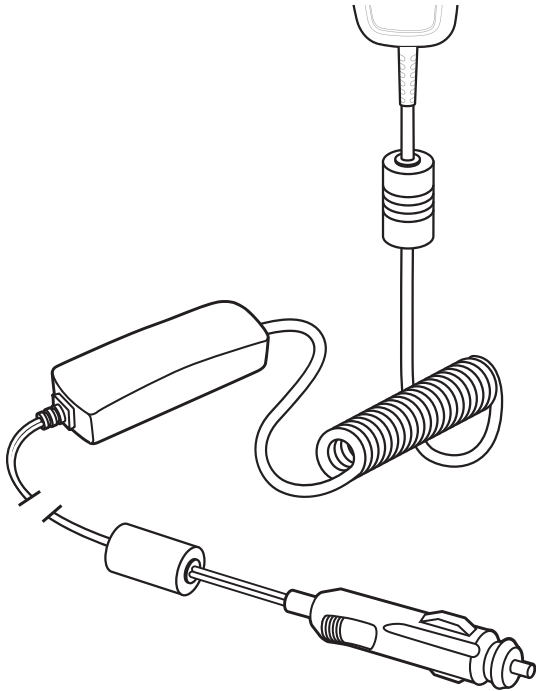

Battery Charging

Main Battery Charging

The device's Charging/Notification LED indicates the status of the battery charging in the device.

The 4620 mAh battery fully charges in less than five hours at room temperature.

Charging Temperature

Charge batteries in temperatures from 0°C to 40°C (32°F to 104°F). The device always performs battery charging in a safe and intelligent manner. At higher temperatures (e.g. approximately +37°C (+98°F)) the device may for small periods of time alternately enable and disable battery charging to keep the battery at acceptable temperatures. The device indicates when charging is disabled due to abnormal temperatures via its LED.

Vehicle Cradle

Refer to the device Integrator Guide for Android Version 8.1 for information on installing the Vehicle Cradle.

The cradle:

- holds the device securely in place
- provides power for operating the device
- re-charges the battery in the device.

The cradle is powered by the vehicle's 12V or 24V electrical system. The operating voltage range is 9V to 32V and supplies a maximum current of 3A.

Figure 183 Vehicle Cradle

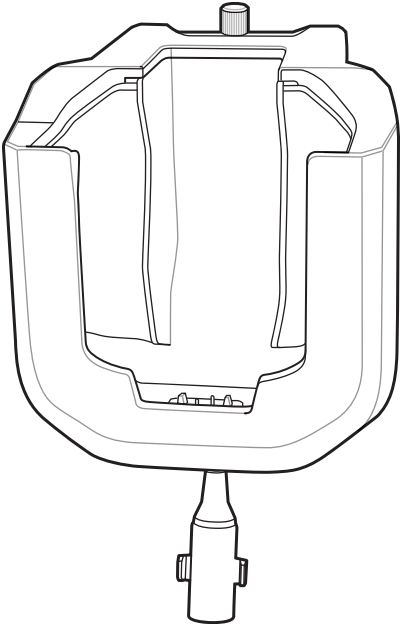

Device Insertion and Removal



CAUTION: Ensure that the device is fully inserted into the cradle. Lack of proper insertion may result in property damage or personal injury. Zebra Technologies Corporation is not responsible for any loss resulting from the use of the products while driving.

To ensure the device was inserted correctly, listen for the audible click that signifies that the device locking mechanism was enabled and the device was locked into place.

Figure 184 Install Device into Vehicle Cradle

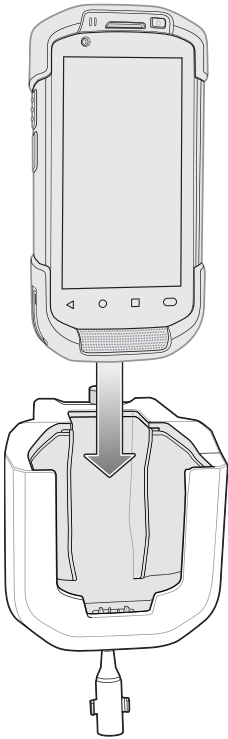

To remove the device from the cradle, grasp the device and lift out of the cradle.

Figure 185 Remove Device from Vehicle Cradle

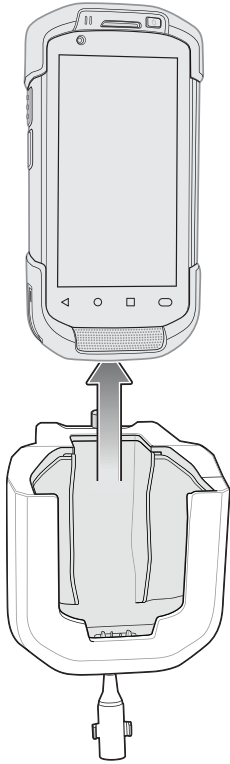

Battery Charging

Ensure the cradle is connected to a power source.

Insert the device into the cradle. The device starts to charge through the cradle as soon as it is inserted. This does not deplete the vehicle battery significantly. The battery charges in approximately four hours. See Table 3 on page 27 for charging indications.



NOTE: The Vehicle Cradle operating temperature is -40°C to $+85^{\circ}\text{C}$. When in the cradle, the device will only charge when its temperature is between 0°C to $+40^{\circ}\text{C}$.

TC7X Vehicle Communication Charging Cradle

The Vehicle Communication Charging Cradle:

- holds the device securely in place
- provides power for operating the device
- re-charges the battery in the device.

The cradle is powered by the USB I/O Hub.

Refer to the device Integrator Guide for Android Version 8.1 for information on installing the TC7X Vehicle Communication Charging Cradle.

Figure 186 TC7X Vehicle Communication Charging Cradle

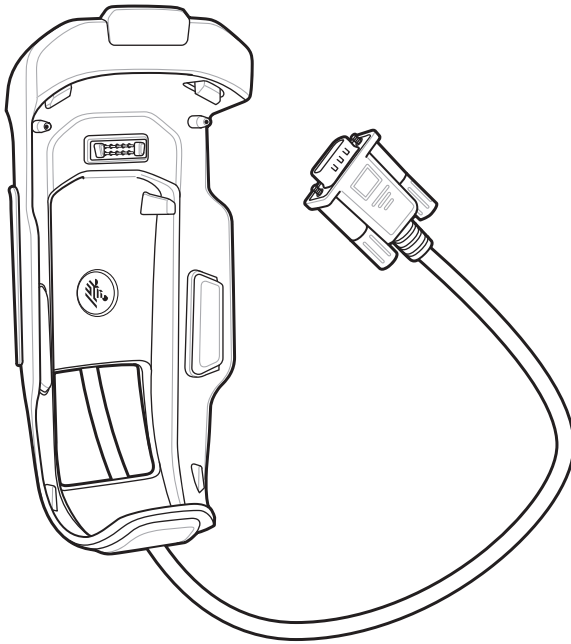

Device Insertion and Removal

Figure 187 Insert Device into Cradle

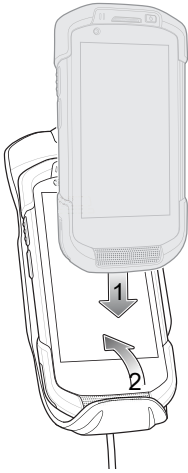
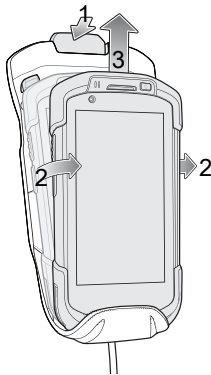

Figure 188 Remove Device from Cradle



To ensure the device was inserted correctly, listen for the audible click that signifies that the device locking mechanism was enabled and the device was locked into place.



CAUTION: Ensure that the device is fully inserted into the cradle. Lack of proper insertion may result in property damage or personal injury. Zebra Technologies Corporation is not responsible for any loss resulting from the use of the products while driving.

To remove the device from the cradle, press the release latch, grasp the device and lift out of the vehicle cradle.

Device Battery Charging

Insert the device into the cradle. The device starts to charge through the cradle as soon as it is inserted. This does not deplete the vehicle battery significantly. The battery charges in approximately four hours. See Table 3 on page 27 for all charging indications.

Charging Note

The Vehicle Cradle operating temperature is -40°C to $+85^{\circ}\text{C}$. When in the cradle, the device will only charge when its temperature is between 0°C to $+40^{\circ}\text{C}$.

USB I/O Hub

The USB I/O Hub:

- provides power to a vehicle cradle
- provides USB hub for three USB devices (such as printers)
- provides a powered USB port for charging another device.

The cradle is powered by the vehicle's 12V or 24V electrical system. The operating voltage range is 9V to 32V and supplies a maximum current of 3A to the vehicle cradle and 1.5 A to the four USB ports simultaneously.

Refer to the device Integrator Guide for Android Version 8.1 for information on installing the USB I/O Hub.

Figure 189 USB I/O Hub

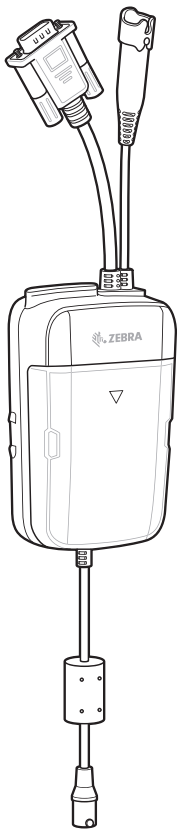

Connect USB Cables

The USB I/O Hub provides three USB ports for connecting devices such as printers to a device in the vehicle cradle. To connect USB cables:

1. Slide the cable cover down and remove.

Figure 190 Remove Cover

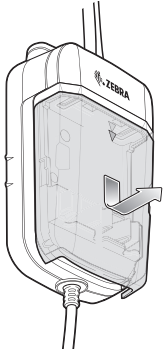

2. Insert the USB cable connector into one of the USB ports.
3. Place each cable into the cable holder.

Figure 191 Connect USB Cable

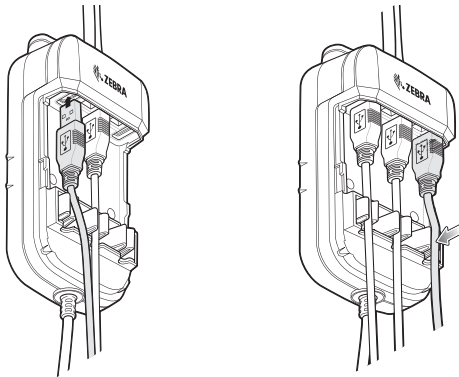

4. Align the cable cover onto the USB I/O Hub. Ensure that the cables are within the cover opening.

Figure 192 Replace Cover

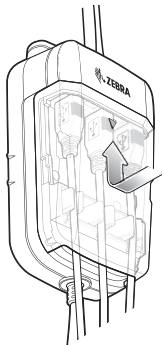

5. Slide cable cover up to lock into place.

External USB Cable

The USB I/O Hub provides a USB port for charging external devices such as cell phones. This port is for charging only.

1. Open the USB Access Cover.
2. Insert the USB cable connector into the USB port.

Figure 193 Insert External USB Cable

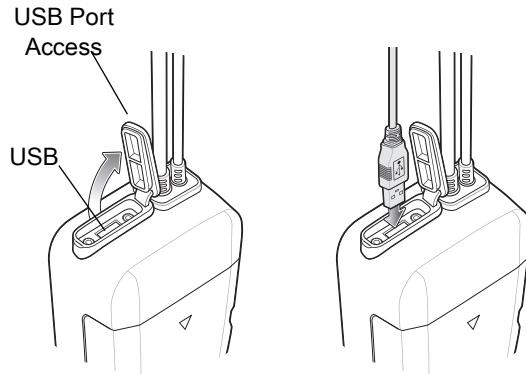

Power to Vehicle Cradle

The USB I/O Hub can provide power to a Vehicle Cradle.

1. Connect the Power Output Cable connector to the Power Input Cable connector of the Vehicle Cradle.
2. Tighten thumbscrews by hand until tight.

Figure 194 Connect Power to Vehicle Cradle

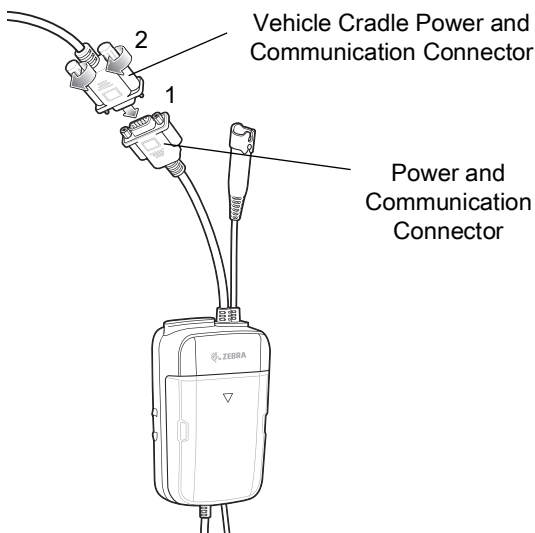

Audio Headset Connection

The USB I/O Hub provides audio connection to the device in a vehicle cradle.

Depending upon, headset, connect the headset and audio adapter to the Headset connector.

Figure 195 Connect Audio Headset

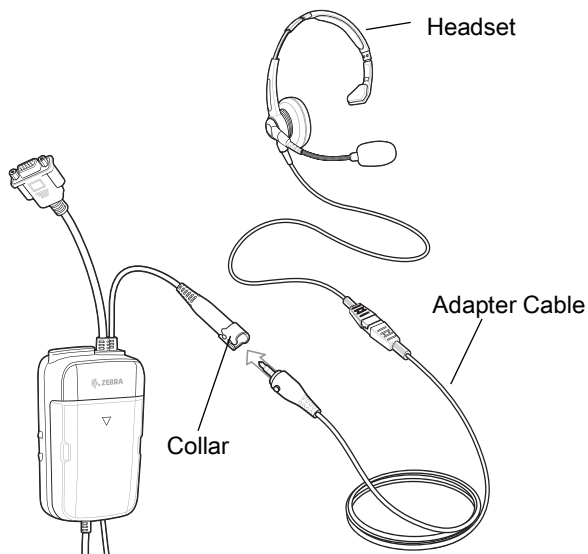

Maintenance and Troubleshooting

This section includes instructions on cleaning and storing the device, and provides troubleshooting solutions for potential problems during operation.

Maintaining the Device

For trouble-free service, observe the following tips when using the device:

- To avoid scratching the screen, use the supplied stylus or plastic-tipped pens intended for use with a touch-sensitive screen. Never use an actual pen or pencil or other sharp object on the surface of the device screen.
- The touch-sensitive screen of the device is glass. Do not drop the device or subject it to strong impact.
- Protect the device from temperature extremes. Do not leave it on the dashboard of a car on a hot day, and keep it away from heat sources.
- Do not store the device in any location that is dusty, damp, or wet.
- Use a soft lens cloth to clean the device. If the surface of the device screen becomes soiled, clean it with a soft cloth moistened with an approved cleanser. For a list of approved cleansers, see [Approved Cleanser Active Ingredients on page 204](#).
- Periodically replace the rechargeable battery to ensure maximum battery life and product performance. Battery life depends on individual usage patterns.

Battery Safety Guidelines

- The area in which the units are charged should be clear of debris and combustible materials or chemicals. Particular care should be taken where the device is charged in a non commercial environment.
- Follow battery usage, storage, and charging guidelines found in this guide.
- Improper battery use may result in a fire, explosion, or other hazard.
- To charge the mobile device battery, the ambient battery and charger temperatures must be between +32°F and +104°F (0°C and +40°C).
- Do not use incompatible batteries and chargers, including non-Zebra batteries and chargers. Use of an incompatible battery or charger may present a risk of fire, explosion, leakage, or other hazard. If you have any questions about the compatibility of a battery or a charger, contact the Global Customer Support Center.
- For devices that utilize a USB port as a charging source, the device shall only be connected to products that bear the USB-IF logo or have completed the USB-IF compliance program.
- Do not disassemble or open, crush, bend or deform, puncture, or shred the battery.

- Severe impact from dropping any battery-operated device on a hard surface could cause the battery to overheat.
- Do not short circuit a battery or allow metallic or conductive objects to contact the battery terminals.
- Do not modify or remanufacture, attempt to insert foreign objects into the battery, immerse or expose to water or other liquids, or expose to fire, explosion, or other hazard.
- Do not leave or store the equipment in or near areas that might get very hot, such as in a parked vehicle or near a radiator or other heat source. Do not place battery into a microwave oven or dryer.
- Battery usage by children should be supervised.
- Please follow local regulations to properly dispose of used re-chargeable batteries.
- Do not dispose of batteries in fire.
- In the event of a battery leak, do not allow the liquid to come in contact with the skin or eyes. If contact has been made, wash the affected area with water for 15 minutes, and seek medical advice.
- If you suspect damage to your equipment or battery, contact Customer Support to arrange for inspection.

Cleaning Instructions



CAUTION: Always wear eye protection. Read warning label on alcohol product before using. If you have to use any other solution for medical reasons please contact the Global Customer Support Center for more information.



WARNING: Avoid exposing this product to contact with hot oil or other flammable liquids. If such exposure occurs, unplug the device and clean the product immediately in accordance with these guidelines.

Approved Cleanser Active Ingredients

100% of the active ingredients in any cleaner must consist of one or some combination of the following: isopropyl alcohol, bleach/sodium hypochlorite¹ (see important note below), hydrogen peroxide, ammonium chloride, or mild dish soap.



IMPORTANT: Use pre-moistened wipes and do not allow liquid cleaner to pool.

¹When using sodium hypochlorite (bleach) based products, always follow the manufacturer's recommended instructions: use gloves during application and remove the residue afterwards with a damp alcohol cloth or a cotton swab to avoid prolonged skin contact while handling the device.

Due to the powerful oxidizing nature of sodium hypochlorite, the metal surfaces on the device are prone to oxidation (corrosion) when exposed to this chemical in the liquid form (including wipes). In the event that these type of disinfectants come in contact with metal on the device, prompt removal with an alcohol-dampened cloth or cotton swab after the cleaning step is critical.

Harmful Ingredients

The following chemicals are known to damage the plastics on the device and should not come in contact with the device: acetone; ketones; ethers; aromatic and chlorinated hydrocarbons; aqueous or alcoholic alkaline solutions; ethanolamine; toluene; trichloroethylene; benzene; carboic acid and TB-lysoform.

Many vinyl gloves contain phthalates additives, which are often not recommended for medical use and are known to be harmful to the housing of the device.

Device Cleaning Instructions

Do not apply liquid directly to the device. Dampen a soft cloth or use pre-moistened wipes. Do not wrap the device in the cloth or wipe, instead gently wipe the unit. Be careful not to let liquid pool around the display window or other places. Before use, allow the unit to air dry.



NOTE: For thorough cleaning, it is recommended to first remove all accessory attachments, such as hand straps or cradle cups, from the mobile device and to clean them separately.

Special Cleaning Notes

The device should not be handled while wearing vinyl gloves containing phthalates, or before hands are washed to remove contaminant residue after gloves are removed.

If products containing any of the harmful ingredients listed above are used prior to handling the device, such as hand sanitizer that contain ethanolamine, hands must be completely dry before handling the device to prevent damage to the device.



IMPORTANT: If the battery connectors are exposed to cleaning agents, thoroughly wipe off as much of the chemical as possible and clean with an alcohol wipe. It is also recommended to install the battery in the terminal prior to cleaning and disinfecting the device to help minimize buildup on the connectors.

When using cleaning/disinfectant agents on the device, it is important to follow the directions prescribed by the cleaning/disinfectant agent manufacturer.

Cleaning Materials Required

- Alcohol wipes
- Lens tissue
- Cotton-tipped applicators
- Isopropyl alcohol
- Can of compressed air with a tube.

Cleaning Frequency

The cleaning frequency is at the customer's discretion due to the varied environments in which the mobile devices are used and may be cleaned as frequently as required. When dirt is visible, it is recommended to clean the mobile device to avoid build up of particles which make the device more difficult to clean later on.

For consistency and optimum image capture, it is recommended to clean the camera window periodically especially when used in environments prone to dirt or dust.

Cleaning the Device

Housing

Thoroughly wipe the housing, including all buttons and triggers, using an approved alcohol wipe.

Display

The display can be wiped down with an approved alcohol wipe, but care should be taken not to allow any pooling of liquid around the edges of the display. Immediately dry the display with a soft, non-abrasive cloth to prevent streaking.

Camera and Exit Window

Wipe the camera and exit window periodically with a lens tissue or other material suitable for cleaning optical material such as eyeglasses.

Cleaning Battery Connectors

To clean the battery connectors:

1. Remove the main battery from the mobile computer.
2. Dip the cotton portion of the cotton-tipped applicator in isopropyl alcohol.
3. To remove any grease or dirt, rub the cotton portion of the cotton-tipped applicator back-and-forth across the connectors on the battery and terminal sides. Do not leave any cotton residue on the connectors.
4. Repeat at least three times.
5. Use a dry cotton-tipped applicator and repeat steps 3 and 4. Do not leave any cotton residue on the connectors.
6. Inspect the area for any grease or dirt and repeat the cleaning process if necessary.



CAUTION: After cleaning the battery connectors with bleach-based chemicals, follow the Battery Connector Cleaning instructions to remove bleach from the connectors.

Cleaning Cradle Connectors

To clean the connectors on a cradle:

1. Remove the DC power cable from the cradle.
2. Dip the cotton portion of the cotton-tipped applicator in isopropyl alcohol.
3. Rub the cotton portion of the cotton-tipped applicator along the pins of the connector. Slowly move the applicator back-and-forth from one side of the connector to the other. Do not leave any cotton residue on the connector.
4. All sides of the connector should also be rubbed with the cotton-tipped applicator.
5. Remove any lint left by the cotton-tipped applicator.
6. If grease and other dirt can be found on other areas of the cradle, use a lint-free cloth and alcohol to remove.
7. Allow at least 10 to 30 minutes (depending on ambient temperature and humidity) for the alcohol to air dry before applying power to cradle.

If the temperature is low and humidity is high, longer drying time is required. Warm temperature and low humidity requires less drying time.



CAUTION: After cleaning the cradle connectors with bleach-based chemicals, follow the Cleaning Cradle Connectors instruc-

tions to remove bleach from the connectors.

Troubleshooting

The following tables provides typical problems that might arise and the solution for correcting the problem.

Table 23 Troubleshooting the device

Problem	Cause	Solution
When pressing the power button the device does not turn on.	Battery not charged.	Charge or replace the battery in the device.
	Battery not installed properly.	Install the battery properly.
	System crash.	Perform a reset.
When pressing the power button the device does not turn on but two LEDs blink.	Battery charge is at a level where data is maintained but battery should be re-charged.	Charge or replace the battery in the device.
Battery did not charge.	Battery failed.	Replace battery. If the device still does not operate, perform a reset.
	device removed from cradle while battery was charging.	Insert device in cradle. The 4620 mAh battery fully charges in less than five hours at room temperature.
	Extreme battery temperature.	Battery does not charge if ambient temperature is below 0°C (32°F) or above 40°C (104°F).
Cannot see characters on display.	device not powered on.	Press the Power button.
During data communication with a host computer, no data transmitted, or transmitted data was incomplete.	device removed from cradle or disconnected from host computer during communication.	Replace the device in the cradle, or reattach the communication cable and re-transmit.
	Incorrect cable configuration.	See the system administrator.
	Communication software was incorrectly installed or configured.	Perform setup.
During data communication over Wi-Fi, no data transmitted, or transmitted data was incomplete.	Wi-Fi radio is not on.	Turn on the Wi-Fi radio.
	You moved out of range of an access point.	Move closer to an access point.

Table 23 Troubleshooting the device (Continued)

Problem	Cause	Solution
During data communication over WAN, no data transmitted, or transmitted data was incomplete.	You are in an area of poor cellular service.	Move into an area that has better service.
	APN is not set up correctly.	See system administrator for APN setup information.
	SIM card not installed properly.	Remove and re-install the SIM card.
	Data plan not activated.	Contact your service provider and ensure that your data plan is enable.
During data communication over Bluetooth, no data transmitted, or transmitted data was incomplete.	Bluetooth radio is not on.	Turn on the Bluetooth radio.
	You moved out of range of another Bluetooth device.	Move within 10 meters (32.8 feet) of the other device.
No sound.	Volume setting is low or turned off.	Adjust the volume.
Device shuts off.	Device is inactive.	The display turns off after a period of inactivity. Set this period to 15 seconds, 30 seconds, 1, 2, 5, 10 or 30 minutes.
	Battery is depleted.	Replace the battery.
Tapping the window buttons or icons does not activate the corresponding feature.	The device is not responding.	Reset the device.
A message appears stating that the device memory is full.	Too many files stored on the device.	Delete unused memos and records. If necessary, save these records on the host computer (or use an SD card for additional memory).
	Too many applications installed on the device.	Remove user-installed applications on the device to recover memory. Select ⚙ > Storage > FREE UP SPACE > REVIEW RECENT ITEMS . Select the unused program(s) and tap FREE UP .

Table 23 Troubleshooting the device (Continued)

Problem	Cause	Solution
The device does not decode with reading barcode.	Scanning application is not loaded.	Load a scanning application on the device or enable DataWedge. See the system administrator.
	Unreadable barcode.	Ensure the symbol is not defaced.
	Distance between exit window and barcode is incorrect.	Place the device within proper scanning range.
	device is not programmed for the barcode.	Program the device to accept the type of barcode being scanned. Refer to the EMDK or DataWedge application.
	device is not programmed to generate a beep.	If the device does not beep on a good decode, set the application to generate a beep on good decode.
	Battery is low.	If the scanner stops emitting a laser beam upon a trigger press, check the battery level. When the battery is low, the scanner shuts off before the device low battery condition notification. Note: If the scanner is still not reading symbols, contact the distributor or the Global Customer Support Center.
The device cannot find any Bluetooth devices nearby.	Too far from other Bluetooth devices.	Move closer to the other Bluetooth device(s), within a range of 10 meters (32.8 feet).
	The Bluetooth device(s) nearby are not turned on.	Turn on the Bluetooth device(s) to find.
	The Bluetooth device(s) are not in discoverable mode.	Set the Bluetooth device(s) to discoverable mode. If needed, refer to the device's user documentation for help.
Cannot unlock device.	User enters incorrect password.	If the user enters an incorrect password eight times, the user is requested to enter a code before trying again. If the user forgot the password, contact system administrator.

Technical Specifications

For device technical specifications, go to zebra.com/us/en/products/mobile-computers/handheld/tc7xseries.

Table 24 *Technical Specifications*

Item	Description
Physical Characteristics	
Dimensions	Height: 161 mm (6.3 in.) Width: 84 mm (3.3 in.) Depth: 28 mm (1.1 in.)
Weight	376 g (13.3 oz)
Display	4.7 in. High Definition (1280 x 720); exceptionally bright image; optically bonded to touch panel with Gorilla Glass™ protection
Touch Panel	Capacitive touch
Backlight	Light Emitting Diode (LED) backlight
Battery Pack	Rechargeable Lithium Ion 3.7V, 4620 mAh battery
Expansion Slot	User accessible microSD up to 32 GB SDHC and up to 128 GB SDXC support
Connection Interface	Universal Serial Bus (USB) 2.0 High Speed (host and client)
Notification	Audible tone plus multi-color LEDs, vibration
Voice and Audio	Three microphone support with noise cancellation; vibrate alert; speaker; Bluetooth wireless headset support. High quality speaker phone with up to 108 db SPL volume; PTT headset support; Cellular circuit switch voice; HD Voice
Performance Characteristics	
CPU	1.8 GHz hex core 64 bit processor (Snapdragon 650)
Operating System	Android 8.1 Oreo
Memory	4 GB RAM/32 GB Flash
Output Power	USB - 5 VDC @ 500 mA max
User Environment	
Operating Temperature	-20°C to 50°C (-4°F to 122°F)
Storage Temperature	-40°C to 70°C (-40°F to 158°F)

Technical Specifications

Table 24 *Technical Specifications (Continued)*

Item	Description
Charging Temperature	0° C to 40° C (32°F to 104°F)
Humidity	5 to 95% non-condensing
Drop Specification	8 ft./2.4 m to concrete at room temperature; 6 ft./1.8 m over the operating temperature range
Tumble	2,000 3.2 ft./1.0 m tumbles; meets and exceeds IEC tumble specifications
Electrostatic Discharge (ESD)	+/-15kVdc air discharge, +/-8kVdc direct discharge, +/-8kVdc indirect discharge
Sealing	IP67 per applicable IEC sealing specifications
Vibration	4 g's PK Sine (5 Hz to 2 kHz); 0.04g2/Hz Random (20 Hz to 2 kHz); 60 minute duration per axis, 3 axis
Thermal Shock	-40° C to 70° C (-40° F to 158° F) rapid transition
Interactive Sensor Technology (IST)	
Motion Sensor	3-axis accelerometer provides motion-sensing for dynamic screen orientation and power management
Light Sensor	Ambient light sensor to auto adjust display backlight brightness
Wireless WAN Data and Voice Communications (TC75x only)	
Frequency band	Worldwide: LTE: 700,800/850/900/1800/2100/2600 (FDD 28,20,5,8,3,1,7); UMTS/HSPA/HSPA+: 850/900/1900/2100; GSM/GPRS/EDGE: 850/900/1800/1900 Americas: LTE: 700/850/1900/AWS/2100, (FDD 13,12,17,5,26,2,25,4,1); UMTS/HSPA/HSPA+: 850, 900, AWS, 1900, 2100 GSM/GPRS/EDGE: 850/900/1800/1900; CDMA: 850,1900 (BC0, BC10, BC1)
GPS	Integrated, Autonomous, Assisted GPS (A-GPS), Navstar, GLONASS, Beidou, Galileo
Wireless LAN Data and Voice Communications	
Radio	2x2 MIMO; IEEE® 802.11a/b/g/n/ac/d/h/i/r
Data Rates Supported	5GHz: 802.11a/n/c - up to 866.7 Mbps 2.4GHz: 802.11b/g/n - up to 144 Mbps
Operating Channels	Chan 1 - 13 (2412 - 2472 MHz), Chan 36 - 165 (5180 - 5825 MHz) Channel Bandwidth: 20, 40, 80 MHz Actual operating channels/frequencies depend on regulatory rules and certification agency
Security	WEP (40 or 104 bit); WPA/WPA2 Personal (TKIP, and AES); WPA/WPA2 Enterprise (TKIP and AES) - EAP-TTLS (PAP, MSCHAP, MSCHAPv2), EAP-TLS, PEAPv0-MSCHAPv2, PEAPv1-EAP-GTC and LEAP
Wireless PAN Data and Voice Communications	
Bluetooth	Bluetooth v4.1 Low Energy
Data Capture Specifications	

Technical Specifications

Table 24 *Technical Specifications (Continued)*

Item	Description
2D Imager	SE4750-SR – 1D and 2D barcodes.
Camera	Rear: 13 Mega pixel auto focus with flash Front: 1.3 Mega pixel fixed focus
Near Field Communications (NFC)	ISO 14443 Type A and B, FeliCa, and ISO 15963 cards. P2P mode and Card Emulation via UICC and Host.
Communication and Messaging	
Workforce Connect PTT Express (included) provides instant push-to-talk (PTT) small group communications across Wi-Fi networks. Workforce Connect PTT Pro (supported) provides a scalable network agnostic push-to-talk solution which also includes messaging, location services and two-way radio integration. Workforce Connect Voice client (supported) enables the TC75x to function as a full featured mobile telephone with multi-line capability across Wi-Fi networks.	
2D Imager Engine (SE4750-SR) Specifications	
Field of View	Horizontal - 48.0° Vertical - 36.7°
Image Resolution	1280 horizontal X 960 vertical pixels
Roll	360°
Pitch Angle	+/- 60° from normal
Skew Tolerance	+/- 60° from normal
Ambient Light	Sunlight: 10,000 ft. candles (107,639 lux)
Focal Distance	From front of engine: 17.7 cm (7.0 in.)
Laser Aiming Element	Visible Laser Diode (VLD): 655 nm +/- 10 nm Central Dot Optical Power: 0.6 mW (typical) Pattern Angle: 48.0° horizontal, 38.0° vertical
Illumination System	LEDs: Warm white LED Pattern Angle: 80° at 505 intensity

Table 25 *Data Capture Supported Symbologies*

Item	Description
1D barcodes	Code 128, EAN-8, EAN-13, GS1 DataBar Expanded, GS1 128, GS1 DataBar Coupon, UPCA, Interleaved 2 of 5, UPC Coupon Code
2D barcodes	PDF-417, QR Code

Index

A

adaptive frequency hopping	147
adjust volume	130
airplane mode	35
alarms only	59
albums	91, 101
deleting	92, 102
getting information	91
sharing	91, 101
working with	91
working with albums	101
ambient display setting	37
apn	143
approved cleanser	204
approved cleanser active ingredients	204
apps	61
accessing	64
adding shortcuts	53
battery manager	71
camera	74
datawedge demonstration	79
device central	81
diagnostic tool	83
files	88
Gallery	89
Messaging	95
photos	97
PTT Express	103
RxLogger	106
RxLogger Utility	107
shortcuts	52
SimulScan Demo	107
sound recorder	115
audio modes	129
automatically block sounds and vibrations	60

B

barcode scanning	
DS3678 digital scanner	118
battery	

low battery notification	34
monitor usage	34
battery management	33
battery level	33
battery present status	33
battery manager	71
battery optimization	35
battery safety guidelines	203
blink light	50
bluetooth	140, 147
change name	150
disabling	149
discovering devices	150
enabling	149
PIN	148
power states	149
profiles	148
security	148
Bluetooth call	136

C

call forwarding	138
call waiting	138
caller ID	138
camera	61, 74
front camera photo settings	77
front camera video settings	78
photo settings	76
rear camera photo settings	77
rear camera video settings	78
recording videos	75
taking panoramic photos	75
taking photos	74
video settings	77
camera settings	76, 77
cast	153
change bluetooth name	150
cleaning	204, 205
battery connectors	206
camera and exit window	206
cradle connectors	206

- display 206
 - frequency 205
 - housing 205
 - instructions 204
 - materials 205
 - cleaning instructions 205
 - conference call 134
 - connect to WLAN 146
 - contacts 79
 - adding 79
 - deleting 79
 - editing 79
 - cradle
 - connector cleaning 206
- D**
- data capture
 - DS3678 digital scanner 118
 - data capture options 14
 - datawedge 128
 - disable 128
 - enable 128
 - datawedge demonstration 79
 - device central 81
 - paging an RS6000 ring scanner 82
 - tabs 82
 - device settings
 - accessing 33
 - diagnostic tool 83
 - battery test information 86
 - bluetooth test information 87
 - gps test information 86
 - settings 86
 - system test information 86
 - wlan test information 87
 - wwan test information 87
 - disable bluetooth 149
 - disconnect host computer 69
 - discover bluetooth devices 150
 - display 14
 - display settings 36
 - display size 40
 - do not disturb feature 58
 - DS3678
 - pairing 127
 - pairing using Bluetooth HID 127
 - scanning 123
 - DS3678 digital scanner
 - barcode scanning 118
 - data capture 118
- E**
- EAP 145
 - edit apn 143
 - emergency calling 129
 - enable bluetooth 149
 - Ethernet connection 171
- F**
- file transfer 69
 - files 88
 - finger usage 40
 - Flash 14, 15
 - folders 53
 - creating 53
 - naming 54
 - removing 54
 - font size 39
- G**
- Gallery 89
 - cropping photos 93
 - deleting albums 92
 - deleting photos 94
 - deleting videos 95
 - getting album information 91
 - setting photos as contact icons 93
 - sharing albums 91
 - sharing photos 94
 - sharing videos 94
 - viewing photos 92
 - watching videos 94
 - working with albums 91
 - working with photos 92
 - working with videos 94
 - general sound setting 41
 - google
 - account setup 27
 - mobile services 44
- H**
- handset mode 129
 - harmful ingredients 204
 - headset mode 129
 - home screen 44
 - moving items 53
 - rotation 45
 - home screen wallpaper 54
- I**
- imager 14, 15
 - interactive sensor technology 67

- K**
- keyboards 55
 - additional character tab 57
 - alpha tab 57
 - configuration 55
 - editing text 56
 - entering numbers, symbols, and special characters .
56
 - numeric tab 56
- L**
- lock screen notifications 50
 - low battery notification 34
- M**
- maintenance 203
 - approved cleanser active ingredients 204
 - battery safety guidelines 203
 - clean battery connectors 206
 - clean camera and exit window 206
 - clean cradle connectors 206
 - clean display 206
 - clean housing 205
 - cleaning frequency 205
 - cleaning instructions 204
 - cleaning materials required 205
 - device cleaning instructions 205
 - harmful ingredients 204
 - maintaining the device 203
 - special cleaning notes 205
 - managing notifications 49
 - memory 14
 - Messaging 95
 - sending a multimedia message 96
 - sending a text message 95
 - messaging 63
 - monitor battery usage 34
 - multimedia messages 96
- N**
- near field communication 140
 - near field communications 151
 - NFC 151
 - reading cards 151
 - sharing information 152
 - notational conventions 16
 - notification icons 48
 - notifications
 - blink light 50
 - lock screen 50
 - managing 49
 - priority notifications only 59
- O**
- operating system 14
- P**
- pairing
 - DS3678 127
 - RS507/RS6000 hands-free imager 124
 - using Bluetooth HID (RS507/RS6000) 126
 - using Bluetooth HID(DS3678) 127
 - using simple serial interface(RS507/RS6000) . . . 125
 - panoramic 75
 - photo transfer 69
 - photos 97
 - camera settings 76
 - cropping 93, 99
 - deleting 94, 101
 - deleting albums 102
 - deleting videos 102
 - panoramic 75
 - setting as contact icons 93, 100
 - sharing 94, 100
 - sharing albums 101
 - sharing videos 102
 - taking 74
 - viewing 92
 - viewing and browsing 98
 - watching videos 102
 - working with 92
 - working with albums 101
 - working with photos 98
 - working with videos 102
 - picklist 116
 - PTT Express
 - audible indicators 103
 - disabling communication 106
 - enabling communication 104
 - group calls 105
 - notification icons 104
 - private response 105
 - talk groups 105
 - user interface 103
 - Voice Client 103
 - PTT-Express
 - PTT communication 105
- Q**
- quick access panel 51
 - quick settings
 - edit icons 52

R

radios	14
RAM	14, 15
reading NFC cards	151
remove wi-fi	147
resetting	68
ringtone	138
RS507	
scanning	120
RS507 hands-free imager	117
RS507 scanning	120, 123
RS507/RS6000	
pairing	124
pairing using Bluetooth HID	126
pairing using simple serial interface	125
RS6000	
bluetooth ring scanner	117
scanning	121
RS6000 scanning	121
RxLogger	106
RxLogger Utility	107

S

scanning	
considerations	118
DS3678	123
RS507	120
RS6000	121
screen font size	39
screen rotation	39
security	145
sensors	211
setting	
camera	76, 77
settings	
accessing	33
ambient display	37
automatically block sounds and vibrations	60
camera photos	76
camera videos	77
display	36
do not disturb	58
general sound	41
home screen wallpaper	54
limit sounds and vibrations	58
override do not disturb for specific apps	61
priority notifications only	59
sharing information using NFC	152
SimulScan Demo	107
advanced settings	113
creating a demo customization	113
default templates	115
printing sample forms	108

settings	112
using the manufacturing example	111
using the postal, transportation and logistics example	109
SMS	63
soft reset	68
software version	15
software versions	15
sound recorder	115
speaker mode	129
status bar	46
symbolologies	212

T

taking a panoramic photo	75
text messages	95
touch mode	40
transferring files using USB	68
troubleshooting	207
TTY	138

U

USB	68
using a wired headset	129
using the dialer	130

V

vehicle cradle	196, 199
videos	
camera settings	77
deleting	95, 102
recording	75
sharing	94, 102
watching	94, 102
working with	94
working with videos	102
voicemail setup	138

W

WEP	145
widgets	52
adding	53
wi-fi network	146
wired headset	129
wireless local area network	140
wireless wide area network	140
WLAN	140
WPA	145
WWAN	140

