

ZQ610 Plus/ZQ620 Plus/ZQ630 Plus

Mobile Printer



ZEBRA

User Guide

2023/09/15

ZEBRA and the stylized Zebra head are trademarks of Zebra Technologies Corporation, registered in many jurisdictions worldwide. All other trademarks are the property of their respective owners. ©2023 Zebra Technologies Corporation and/or its affiliates. All rights reserved.

Information in this document is subject to change without notice. The software described in this document is furnished under a license agreement or nondisclosure agreement. The software may be used or copied only in accordance with the terms of those agreements.

For further information regarding legal and proprietary statements, please go to:

SOFTWARE: zebra.com/linkoslegal.

COPYRIGHTS: zebra.com/copyright.

PATENTS: ip.zebra.com.

WARRANTY: zebra.com/warranty.

END USER LICENSE AGREEMENT: zebra.com/eula.

Terms of Use

Proprietary Statement

This manual contains proprietary information of Zebra Technologies Corporation and its subsidiaries ("Zebra Technologies"). It is intended solely for the information and use of parties operating and maintaining the equipment described herein. Such proprietary information may not be used, reproduced, or disclosed to any other parties for any other purpose without the express, written permission of Zebra Technologies.

Product Improvements

Continuous improvement of products is a policy of Zebra Technologies. All specifications and designs are subject to change without notice.

Liability Disclaimer

Zebra Technologies takes steps to ensure that its published Engineering specifications and manuals are correct; however, errors do occur. Zebra Technologies reserves the right to correct any such errors and disclaims liability resulting therefrom.

Limitation of Liability

In no event shall Zebra Technologies or anyone else involved in the creation, production, or delivery of the accompanying product (including hardware and software) be liable for any damages whatsoever (including, without limitation, consequential damages including loss of business profits, business interruption, or loss of business information) arising out of the use of, the results of use of, or inability to use such product, even if Zebra Technologies has been advised of the possibility of such damages. Some jurisdictions do not allow the exclusion or limitation of incidental or consequential damages, so the above limitation or exclusion may not apply to you.

Contents

Introduction.....	6
Printing Technology.....	7
Healthcare Printers (ZQ610 Plus-HC/ZQ620 Plus-HC).....	7
QR Code and Support Page URL.....	8
Components.....	8
Basic Drawing and Information about Parts.....	9
Control Panel.....	12
Getting Started.....	22
Unpacking and Inspection.....	22
Unpacking and RMA.....	22
Ordering Supplies and Accessories.....	23
Accessories.....	23
Installing Drivers and Connecting to a Windows-Based Computer.....	26
Installing the Drivers.....	26
What to Do If You Forget to Install Printer Drivers First.....	27
Zebra Setup Utilities.....	29
Cable Connection.....	36
Cable Communication.....	37
Providing Strain Relief for Communication Cables.....	38
Using Batteries.....	39
Battery Safety.....	40
Extending Battery Life.....	40
Removing the Battery.....	40
Removing the Battery Tape Insulator.....	42

Installing the Battery.....	42
Battery Charging and Cradles.....	43
Charging the Battery.....	43
Loading Media.....	52
Loading Media in Tear-Off Mode.....	53
Loading Media in Peel-Off Mode (ZQ610 Plus/ZQ620 Plus).....	54
Loading Media in Peel-Off Mode (ZQ630 Plus).....	56
Printing a Test Label.....	58
Wearing the Printer.....	59
Swivel Belt Clip.....	59
Metal Belt Clip.....	60
Adjustable Shoulder Strap.....	61
Soft Case.....	62
Hand Strap.....	64
Hard Case.....	64
Waist Holster.....	66
Configuring the Printer.....	71
Changing Printer Settings - User Menus.....	71
Settings Menu.....	71
Tools Menu.....	73
Network Menu.....	75
RFID Menu.....	80
Language Menu.....	82
Sensors Menu.....	84
Communications Menu.....	84
Bluetooth Menu.....	85
Battery Menu.....	86
RFID Calibration.....	89
RFID Calibration Process.....	89
Using the Printer.....	90
Creating Labels.....	90

Using Label Design Content.....	90
Using ZPL/CPCL/EPL Commands.....	91
Label Design Considerations.....	91
Wireless Communications with Bluetooth.....	96
WLAN Overview.....	98
Print Touch/NFC.....	99
Radio Frequency Identification (RFID).....	100
Maintaining the Printer.....	102
Recommended Cleaning Schedule.....	102
Cleaning the Linerless Printer (ZQ610 Plus/ZQ620 Plus).....	104
Cleaning the Linerless Printer (ZQ630 Plus).....	105
Troubleshooting.....	106
Contacting Technical Support.....	106
Error Indicators.....	106
Error Messages.....	107
Printing a Configuration Label.....	110
Configuration Label Example.....	111
Troubleshooting Issues.....	114
Communication Issues.....	115
Specifications.....	117
Printer Specifications.....	117
Power Specifications.....	117
Communication Interface Specifications.....	118
Media Specifications.....	118
ZPL Font and Barcode Specifications and Commands.....	119
CPCL Font and Barcode Specifications and Commands.....	120
Communication Ports.....	122

Introduction

This guide provides information to operate the ZQ600 Plus Series printers. The printers use some of the latest technologies such as:

- Wi-Fi 6 dual radio (802.11ax + Bluetooth 5.3)*
- Wi-Fi 5 dual radio (802.11ac + Bluetooth 4.2)*
- Optional RFID capability
- Smart battery with PowerPrecision+ functionality
- Near Field Communication (NFC)
- Color LCD display
- Made for iPhone (MFi). The ZQ600 Plus Series printers support communication with Apple devices - such as an iPhone or iPad - running iOS 10 or later over Bluetooth 5.3 and 4.2 (Classic and BLE).



NOTE: * Zebra allows you to choose between a device equipped with Wi-Fi 6 or Wi-Fi 5 dual radio.

The printers use CPCL, ZPL, and EPL programming languages to configure the printer and print properties, label design, and communications. Refer to the CPCL Programming Guide, ZPL Programming Guide, and EPL Programming Guide at zebra.com/support.

Software Resources and Utilities:

- ZebraNet Bridge Enterprise: printer configuration, fleet management
- Zebra Printer Setup Utilities: single printer configuration, quick setup
- ZebraDesigner Professional 3: label design
- Zebra Designer Drivers: Windows drivers
- OPOS Driver: Windows driver
- Multiplatform SDK
- Zebra Downloader
- Printer Profile Manager Enterprise (PPME)

These utilities are found on the Zebra website at zebra.com/us/en/support-downloads.

Printing Technology

The ZQ600 Plus Series printers incorporate a blend of established technologies made popular in other Zebra mobile printer product lines.

Direct Thermal Technology

The ZQ600 Plus Series printers use the direct thermal method to print human-readable text, graphics, and barcodes. It incorporates a sophisticated print engine for optimal printing under all operational conditions. Direct thermal printing uses heat to cause a chemical reaction on specially treated media. This reaction creates a dark mark wherever a heated element on the printhead comes in contact with the media. Because the printing elements are arranged very densely at 203 dpi (dots per inch) horizontal and 200 dpi vertical, highly legible characters and graphic elements may be created a row at a time as the media advances past the printhead. This technology has the advantage of simplicity, as there is no requirement for consumable supplies such as ink or toner. However, because the media is sensitive to heat, it gradually loses legibility over long periods of time, especially if exposed to environments with relatively high temperatures or in direct sunlight.

Adaptive Print Performance

The ZQ600 Plus Series printers use PSPT PrintSmart Gen 2 technology, which adapts to your print conditions so print quality is not sacrificed. When the printer sees environmental conditions such as state of charge, battery health, cold temperature extremes, or high-density printing, the printer adjusts print performance to preserve battery function and allow printing to continue. This may affect the speed and sound of printing but not print quality.

Healthcare Printers (ZQ610 Plus-HC/ZQ620 Plus-HC)

The ZQ610 Plus-HC and ZQ620 Plus-HC are 2- and 3-inch printers designed to meet the specific and unique needs of the healthcare environment. The healthcare setting relies on the printers for barcode label printing while still retaining the printer's capability to print receipts.

The ZQ610 Plus-HC and ZQ620 Plus-HC offer a few key enhancements:

- Provides printers with distinctive white and blue healthcare colors and performance plastics that can be disinfected with most cleaners used in hospitals.
- Leverages the technology advancements made on the ZQ600 Plus Series platform, for example, a new LCD display, Wi-Fi 6 dual radio (802.11ax + Bluetooth 5.3) and Wi-Fi 5 dual radio (802.11ac + Bluetooth 4.2), NFC, and QR code.

Figure 1 ZQ620 Plus-HC Healthcare Model

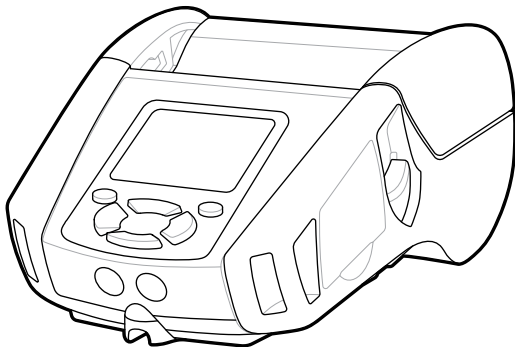

Because the healthcare printers are based on the ZQ610 Plus and ZQ620 Plus platforms, they are direct thermal printers supporting variable print widths. The devices provide print experiences comparable to the ZQ610 Plus and ZQ620 Plus, specifically in the areas of:

- Supporting the same barcodes, barcode quality, and visual print quality.
- Offering equal wireless performance in terms of range, reliability, and speed.
- with all ZQ600 Plus Series accessories and a separate IEC60601 AC adapter exclusive to healthcare printers.

The healthcare printers are designed and tested to endure constant cleaning throughout their lifespan.



NOTE: Refer to the Cleaning and Disinfecting Guidelines for detailed information on cleaning healthcare printers.

QR Code and Support Page URL

The QR barcode includes a human-readable text URL, for example, zebra.com/zq600plus-info, which directs you to printer information and short videos on buying supplies, features overview, loading media, printing a configuration report, cleaning instructions, and accessory information.

Figure 2 QR Code

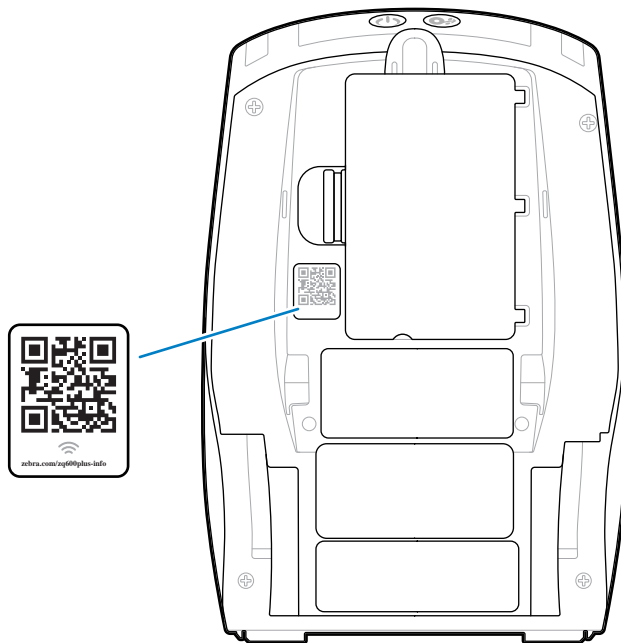

Components

Various components make up your printer and contribute to the overall performance of the printer. Depending on the printer model and the installed options, your printer may look slightly different. The labeled components are mentioned in procedures throughout this manual.

Basic Drawing and Information about Parts

Figure 3 Printer Components - Overhead View (ZQ610 Plus/ZQ620 Plus)

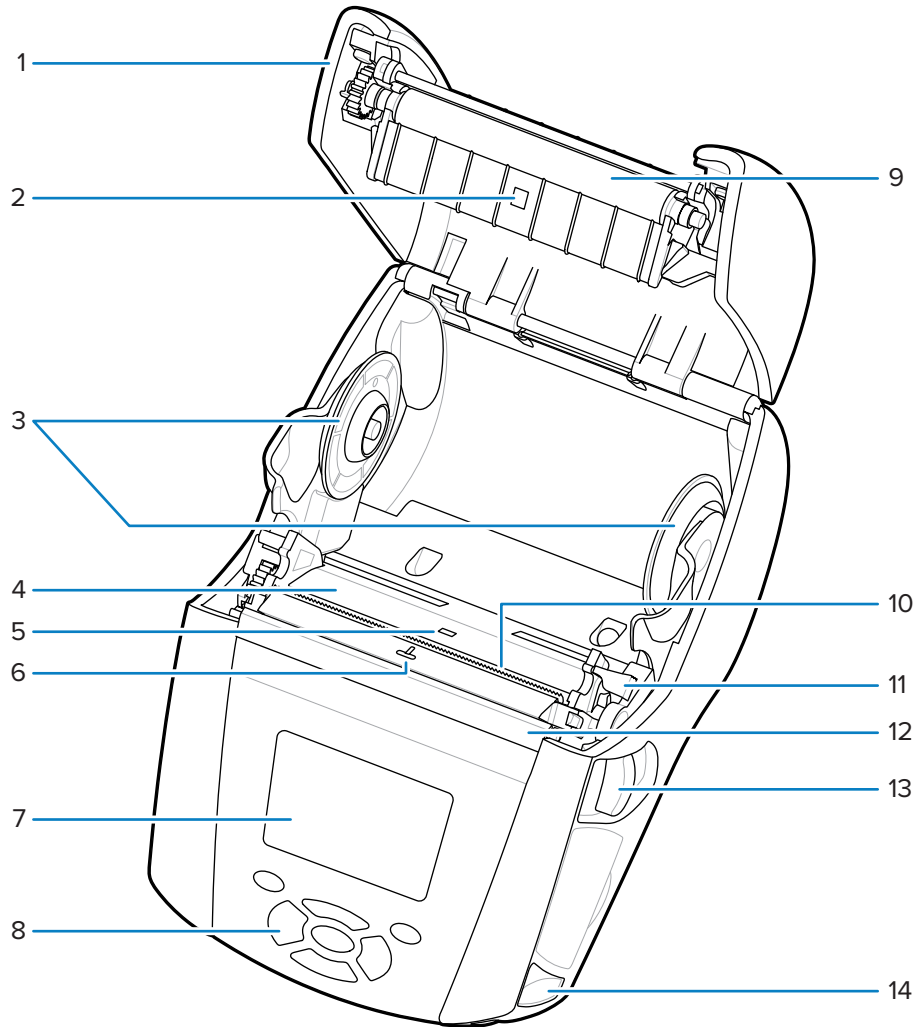

1	Media Cover
2	Black Bar Sensor
3	Media Support Disks
4	Printhead
5	Gap Sensor
6	Label Presence Sensor
7	Color LCD Display
8	Key Pad
9	Platen Roller

10	Tear Bar
11	Peeler Lever
12	Peeler Bail
13	Latch Release Lever
14	Strap Post

Figure 4 Printer Components - Overhead View (ZQ630 Plus)

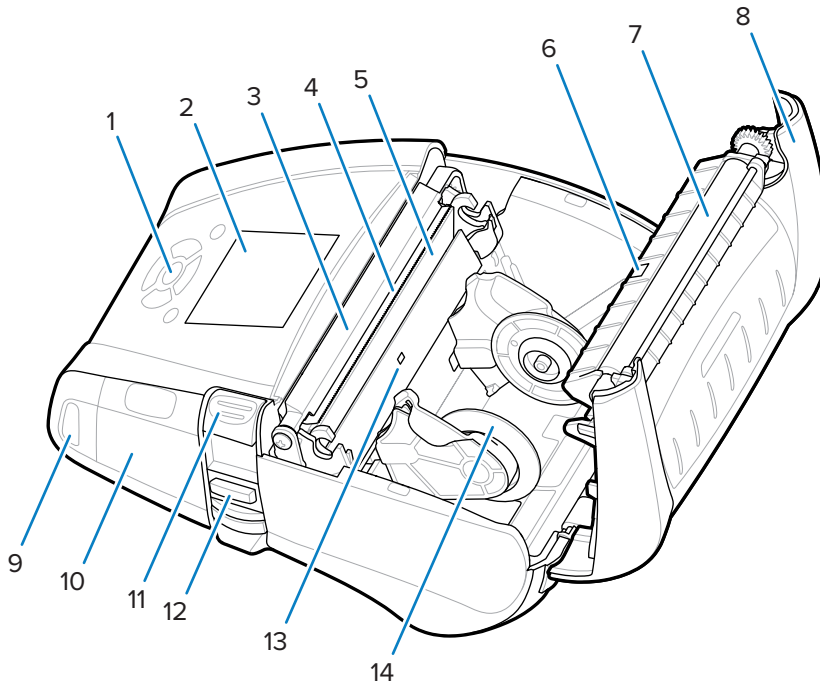

1	Key Pad
2	Color LCD Display
3	Peeler Bail
4	Tear Bar
5	Printhead
6	Black Bar Sensor
7	Platten Roller
8	Media Cover
9	Strap Post
10	USB/RS-232 Comm Ports
11	Latch Release Lever

12	Peeler Lever
13	Gap Sensor
14	Media Support Disk

Figure 5 Printer Components - Front View

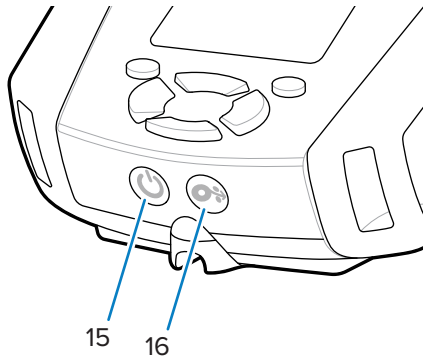

15	Power Button (w/ Power Ring LED)
16	Feed Button

Figure 6 Printer Components - Bottom View

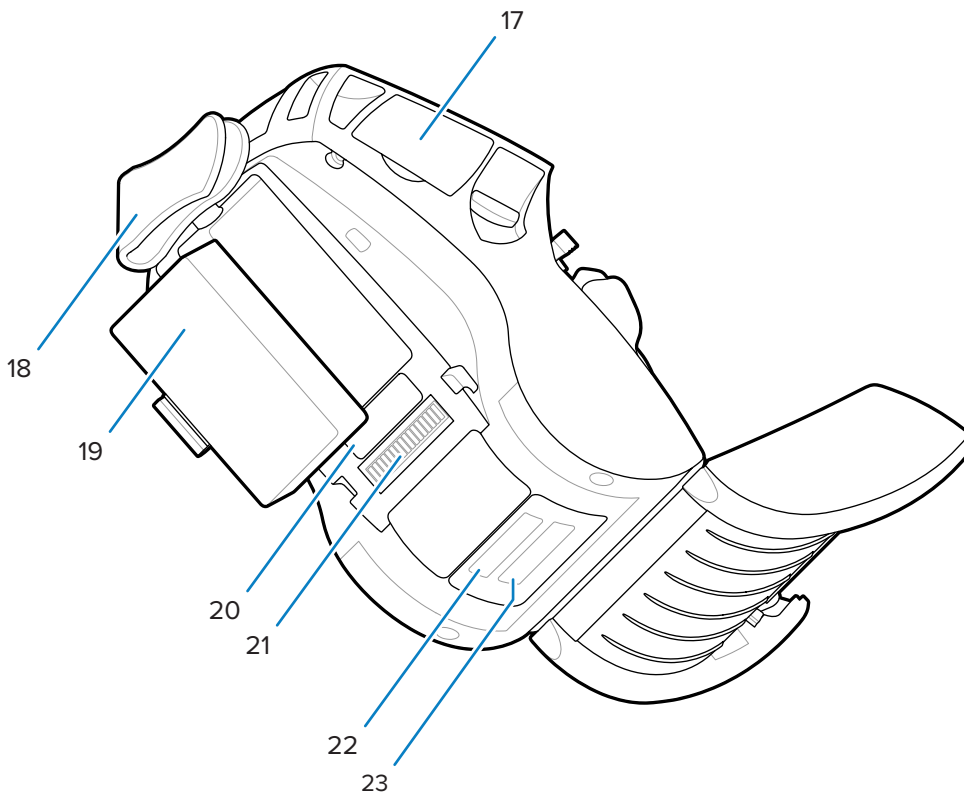

17	USB/RS-232 Comm Ports
18	Belt Clip
19	Battery
20	MAC Address Label
21	Docking Contacts
22	PCC Barcode
23	Serial Number Barcode

Figure 7 Printer Components - Side View

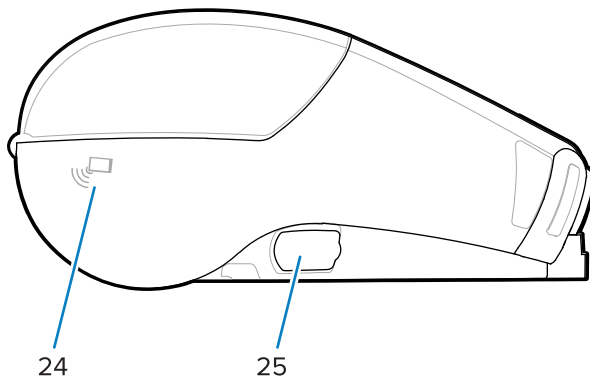

24	NFC (Print Touch Icon)
25	DC Input



NOTE:

- Scanning the QR code with a smartphone provides printer-specific information.
- Tapping the Zebra Print Touch™ icon with a Near Field Communication (NFC) enabled smartphone provides instant access to printer-specific information. For more information about NFC and Zebra products, go to zebra.com/nfc. Bluetooth pairing applications via NFC is also possible. Refer to Zebra Multi-platform SDK for more information.

Control Panel

The ZQ600 Plus Series printers are equipped with a keypad control panel, a color LCD graphical user interface, and two multipurpose buttons. The LCD interface allows easy display and selection of many printer functions. Some features of the LCD interface include:

- A color, non-touch LCD display supporting a 288x240 pixel viewable area.
- View the display in both room light and nighttime conditions.
- Capable of displaying colored text and images.
- To save power, the display dims after a configurable timeout.

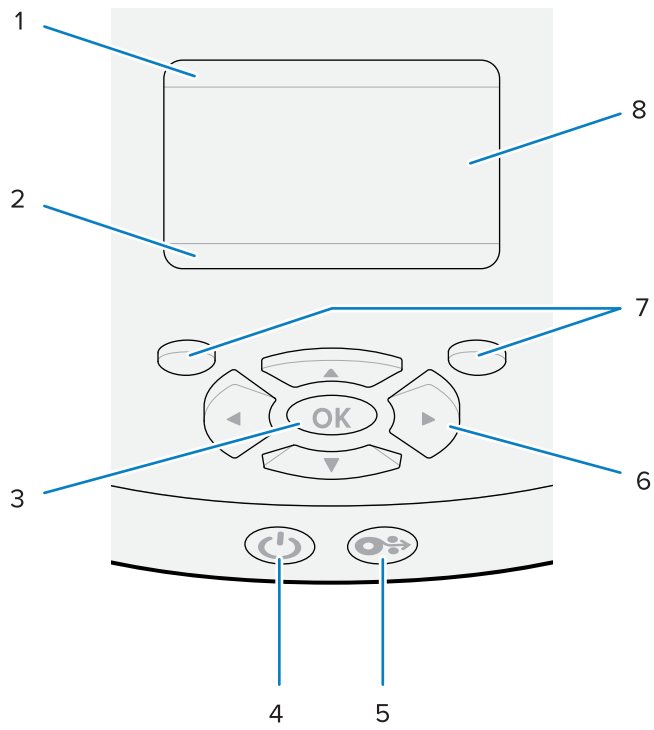
Figure 8 Control Panel

1	Printer status bar	Indicates the status of several printer functions.*
2	Navigation bar	Displays user-selectable options.
3	OK button	Selects or confirms what is shown on the display.



4	POWER button	<p>The POWER button turns the printer on and off. It also puts the printer in Sleep mode and wakes it from Sleep.</p> <p>Normal Boot-Up Behavior</p> <ul style="list-style-type: none"> Press POWER to turn on the printer. When POWER is released, the power ring blinks as the printer boots up. When the boot-up sequence is complete, the power ring stops blinking and remains steadily lit. The color of the power ring depends on the charge status. <p>Sleep Mode LED Behavior</p> <ul style="list-style-type: none"> Pressing POWER for less than 3 seconds puts the printer into Sleep mode. During Sleep mode, the POWER slowly pulses either Green, Amber, or Red, depending on whether the printer is charging successfully. <p>Shutdown Behavior</p> <ul style="list-style-type: none"> Press POWER for approximately 3 seconds to turn the printer off. SHUTTING DOWN appears on the display before the printer shuts down.
5	FEED button	Press FEED to advance a blank label or a software-determined length of journal media.
6	ARROW buttons	The UP ARROW and DOWN ARROW change the parameter values. The LEFT ARROW and RIGHT ARROW navigate to the left and right.
7	LEFT SELECT button	Execute the commands shown directly above them in the display.
	RIGHT SELECT button	
8	Display	Shows the printer's current status and allows the user to navigate the menu system.



* Only icons relevant to the current printer status display.

Power-up and Runtime Sequences

Use the ZQ600 Plus Series printer's multi-button interface to run the following power-up and runtime sequences.

Power-up Sequences

Sequence	Function	Keys	Button
1	Two-key report	Hold FEED while pressing POWER .	 

Sequence	Function	Keys	Button
2	Revert to factory WML	Hold UP and DOWN ARROWS while pressing POWER .	
3	Forced download	Hold both LEFT and RIGHT SELECT while pressing POWER .	
4	Turn the printer On or Off to enter Sleep mode.	Press POWER .	

**NOTE:**

- You may need to revert to factory WML and return to the full menu if custom WML features are turned off.
- If a change causes the WML system to lock up, reboot to temporarily restore functionality.
- A forced download refers to a mode in which the printer powers up to enable firmware downloads. In this mode, the printer runs a specific code that facilitates the process of downloading and installing firmware updates.

Runtime Sequences

Sequence	Function	Keys	Button
1	Media feed	FEED	
2	Wake - If in Sleep mode	Any button	

Sleep Mode

The Sleep mode feature preserves battery life by automatically entering a sleep state after 20 minutes of inactivity. In this state, content is not displayed on the LCD and the backlight is off. Other power management features of the ZQ600 Plus Series printers include Wake on Bluetooth and Wake on WiFi (the printer exits Sleep mode due to data exchanged via Bluetooth or a network message received over WiFi). The printer does not enter Sleep mode when docked in an Ethernet cradle.

To enable or disable Sleep mode:

1. Send the power.sleep.enable command to the printer using Printer Setup Utilities (PSU).
2. Set it to On (default) or Off.

To set the time after which the printer enters Sleep mode:

1. Send the power.sleep.timeout (in seconds) to the printer using PSU.

Draft Mode

You can configure the printer to print in Draft mode via SGD command media.draft_mode (default is Off), which optimizes the printer for text-only printing. While in Draft mode, print speed increases from 4–5 ips (inches per second) with an approximately 22% reduction in optical density.



NOTE: For an explanation and a list of all SGD commands, refer to the Programming Guide at zebra.com/support.

Navigating through Screens in the Printer Display

The following topics detail:

- Options available for navigating through the screens in the ZQ600 Plus Series printer control panel display.
- How to select or modify display options.

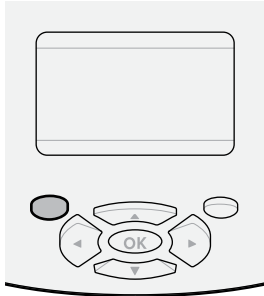

Idle Display

At the Idle Display, press **LEFT SELECT** to go to the printer's Home menu.

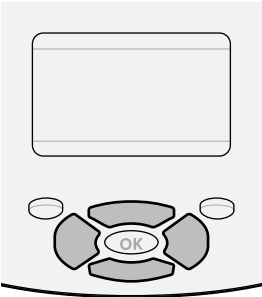

Home Menu

This section describes how to navigate the Home menu.

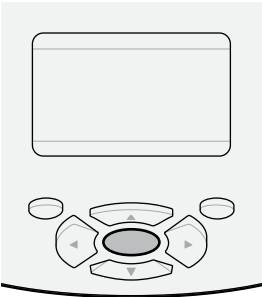
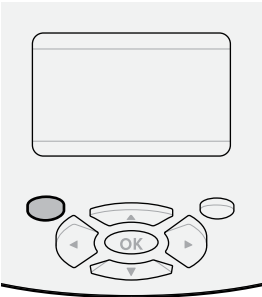
 <p>To move from icon to icon in the Home menu, press any of the ARROW buttons. When an icon is selected, its colors are reversed to highlight it.</p> <p> SETTINGS Menu icon</p> <p> SETTINGS Menu icon selected</p>	 <p>To select the highlighted menu icon and enter the menu, press OK.</p>	 <p>Press LEFT SELECT to exit the Home menu and return to the Idle Display. After 15 seconds of inactivity in the Home menu, the printer automatically returns to the Idle Display.</p>
---	---	---

User Menus

This section describes how to navigate the User menus.

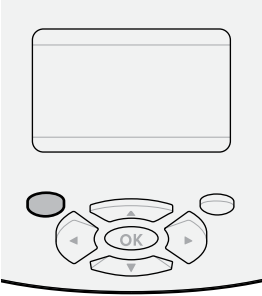
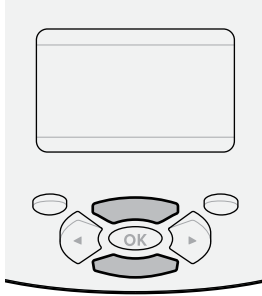
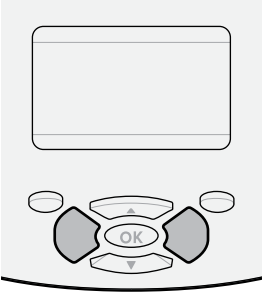
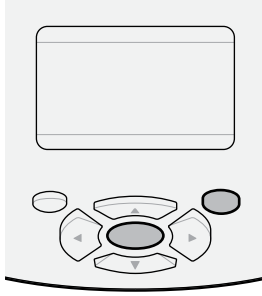
 <p>Press LEFT SELECT to return to the Home menu. The printer automatically returns to the Home menu after 15 seconds of inactivity in a user menu.</p>	 <p>▼ and ▲ indicate that a value can be changed. Any changes that you make are saved immediately. Press the UP ARROW or DOWN ARROW to scroll through accepted values.</p>
 <p>To scroll through the items in a user menu, press the LEFT ARROW or RIGHT ARROW.</p>	 <p>A word in the bottom-right corner of the display indicates an available action. Press OK or press RIGHT SELECT to perform the action shown.</p>

Idle Display, Home Menu, and User Menus

The ZQ600 Plus Series printers' control panel includes a display to view the printer's status or change its operating parameters.

Idle Display

After the printer finishes its power-up sequence, it transitions to the Idle Display. In this state, the printer displays information such as the installed firmware version and IP address.

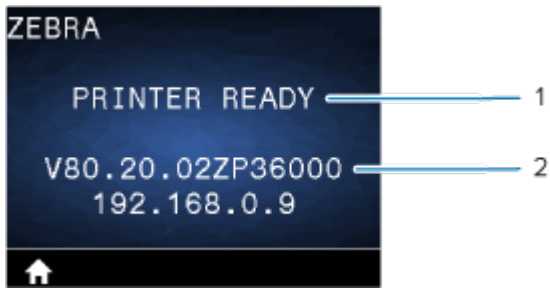
Figure 9 Idle Display

1	The printer's current status.
2	Firmware version and IP address.
	Home menu shortcut.

Home Menu



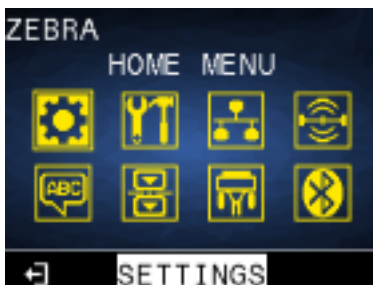

Use the Home menu to access the printer's operating parameters through the eight user menus.



Figure 10 Home Menu

	Exit and return to the Idle Display.
---	--------------------------------------

User Menus

















The following list describes the User Menu icons that are used to change the printer's configuration. To change the printer's configurations, go to [Configuring the Printer](#) on page 71.

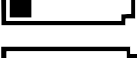
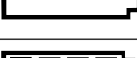





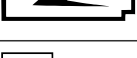
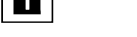

	Settings Menu
	Tools Menu
	Network Menu
	RFID Menu
	Language Menu

	Sensors Menu
	Communications Menu
	Battery Menu

Status Icons

The top of the display shows several icons which indicate the status of various printer functions. Check the indicator status, then refer to the Troubleshooting topic referenced in the chart to resolve the problem.







Icon	Status	Indication
	Solid blue	Bluetooth link established
	Not present	Bluetooth link inactive
	Blinking blue	Connecting or transmitting labels
   	Antenna blinking	Looking for AP
	Antenna blinking/1 signal steady	WLAN associated and attempting authentication
	Antenna blinking/2 signals steady	WLAN associated and authenticated
	Antenna blinking/2 signals blinking	Receiving data
	Not present	No radio present
    	4 Green bars	>80% charged
	3 Green bars	60-80% charged
	2 Yellow bars	40-60% charged
	1 Red bar	20-40% charged
	0 bars (Red battery outline)	Low battery
		
     	4 green blinking with the lightning bolt	Charging >80% capacity
	3 green blinking with the lightning bolt	Charging 60-80% capacity
	2 yellow blinking with the lightning bolt	Charging 40-60% capacity
	1 red blinking with the lightning bolt	Charging 20-40% capacity
	0 bars with red lightning bolt	Low battery
		
	Blinking red	Media cover open



Icon	Status	Indication
	Blinking green	Receiving data
	Solid green	Ethernet connected
	Not present	No ethernet connection
	Blinking green	Data processing in progress
	Solid green	No data being processed
	Blinking red	Out of media
	Solid white	Media present
	Blinking red	Error exists (excluding Media Out and Head Latch Open)
	Not present	No error exists
    	4 green bars	802.11 signal strength >75%
	3 green bars	802.11 signal strength <=75%
	2 green bars	802.11 signal strength <=50% but >25%
	1 yellow bar	802.11 signal strength <=25%
	0 bars	No signal strength

Status Lights

The **POWER** button is surrounded by a three-color (green, amber, red) LED ring.

 = Blinking	 = Solid State	 = Pulsing
--	---	---

Indicator Lights	What they indicate
	Blink green/amber/red during boot-up
	Power On/Charged battery
	Pulse green indicates Sleep mode/Not charging
	Power On/Battery charging
	Charging in Sleep mode
	Charging/Charge complete (unhealthy)

Indicator Lights	What they indicate
	Charging/Charge complete (unhealthy/Sleep mode)
	Charge fault

Getting Started

This section assists users with initial setup and operation of the printer.

Unpacking and Inspection

This section describes unpacking and inspecting the box contents.

1. Carefully remove all protective material from the device and save the shipping container for later storage and shipping.
2. Verify that the following were received:
 - Quick Start Guide
 - Printer
 - Battery Pack
 - Regulatory Guide
 - Belt Clip
3. Check all exterior surfaces for damage.
4. Open the printer media cover (go to [Loading Media](#) on page 52) and inspect the media compartment for damage.
5. Before using the device for the first time, remove the protective shipping film that covers the LCD display.



NOTE: Accessories may vary by region.

Unpacking and RMA

If you discover shipping damage:

- Immediately notify and file a damage report with the shipping company. Zebra Technologies Corporation is not responsible for any damage incurred during shipment of the printer and will not cover the repair of this damage under its warranty policy.
- Keep the carton and all packing material for inspection.
- Notify your authorized Zebra reseller.

Ordering Supplies and Accessories

To ensure maximum printer life and consistent print quality and performance for your needs, it is recommended that only Zebra-produced media be used. This includes Zebra RFID media made for the ZQ630 Plus, as non-Zebra RFID media may not pass RFID calibration.

The advantages of using Zebra supplies and accessories include:

- Consistent quality and reliability of media products.
- A large range of stocked and standard formats.
- In-house custom format design service.
- A large production capacity that services the needs of many large and small media consumers, including major retail chains worldwide.
- Media products that meet or exceed industry standards.

For more information, go to zebra.com/supplies.

Accessories

This section provides a list of accessories available for the ZQ600 Plus series.

Accessories for the ZQ600 Plus Series

Part Number	Description
P1031365-006	KIT ACC QLn220 RUBBER DOOR I/O (15)
P1031365-018	KIT ACC QLn320 RUBBER DOOR I/O (15)
P1031365-019	KIT ACC QLn220/QLn320 RUBBER DOOR DC JACK (15)
P1031365-022	KIT ACC QLn220/320 PLATEN GEAR 48P 22T (25)
P1031365-024	KIT ACC MOBILE AC ADAPTER US (type A) cord
P1031365-027	KIT ACC QLn HAND STRAP
P1031365-028	KIT ACC QLn BELT CLIP REPLACEMENT (20)
P1031365-029	KIT ACC QLn320 SOFT CASE (Includes Shoulder Strap)
P1031365-033	KIT ACC QLn-EC AC ADAPTER US (type A) CORD (see Sales for other countries)
P1031365-038	KIT ACC QLN-EC
P1031365-044	KIT ACC QLn220 SOFT CASE (Includes Shoulder Strap)
P1031365-045	KIT ACC QLN-EC4 AC ADAPTER US CORD (see Sales for other countries)
P1031365-050	KIT ACC EC4 WALL MOUNT
P1031365-052	KIT ACC QLn SERIAL CABLE (with strain relief) QL ADAPTER (female DIN)
P1031365-053	KIT ACC QLn SERIAL CABLE, 6' (with strain relief) PC-DB9
P1031365-054	KIT ACC QLn SERIAL CABLE (with strain relief) to MC9000

Getting Started

Part Number	Description
P1031365-055	KIT ACC QLn PC-USB CABLE, 6' (with strain relief)
P1031365-056	KIT ACC QLn SERIAL CABLE (with strain relief) RJ45 to TELZON ADAPTER
P1031365-057	KIT ACC QLn SERIAL CABLE (with strain relief) to LS2208 Scanner
P1031365-058	KIT ACC QLn 16 PIN SERIAL CABLE (with strain relief) to MC3000
P1031365-059	KIT ACC QLn220/QLN320 SPARE BATTERY SMART
P1031365-060	KIT ACC QLn 11 PIN SERIAL CABLE (with strain relief) to MC3000
P1031365-061	KIT ACC QLn SERIAL DEX CABLE (with strain relief)
P1031365-062	KIT ACC QLn SERIAL CABLE (with strain relief) to RJ45
P1031365-063	KIT ACC SC2 Li-ION SMART CHARGER, US (type A) CORD (see Sales for other countries)
P1031365-069	KIT, ACC QLn220/320 and ZQ500 SERIES SPARE EXTENDED BATTERY with LED's
P1031365-192	KIT ACC QLn SERIES SHOULDER STRAP
P1031365-104	KIT ACC QLn SERIAL CABLE (with strain relief) to LS2208 SCANNER EXTENDED
P1024458-002	BELT,CLIP,QLN,HC
AC11775-5	MODEL UCLI72-4 QUAD BATTERY CHARGER (US line cord, see Sales for others)
BTRY-MPP-34MA1-01	3400 mAh BATTERY for ZQ6 and ZQ500 SERIES
BTRY-MPP-34MAHC1-01	3400 mAh BATTERY for ZQ6 HEALTHCARE PRINTER
SAC-MPP-3BCHGUS1-01	3-SLOT BATTERY CHARGER
SAC-MPP-6BCHUS1-01	DUAL 3-Slot BATTERY CHARGER
SAC-MPP-1BCHGUS1-01	1-SLOT BATTERY CHARGER
VAM-MPP-VHCH1-01	VEHICLE ADAPTER
P1065668-008	KIT,ACC,QLn,AC ADAPTER,STRAIGHT,30W,HC with US (type A) CORD

Accessories for the ZQ630 Plus

Part Number	Description
BTRY-MPP-68MA1-01	KIT ACC ZQ630 SPARE SMART BATTERY
P1050667-007	KIT ACC QLn420 RUBBER DOOR I/O (15)
P1050667-010	KIT ACC QLn420 RUBBER DOOR DC JACK (15)
P1050667-017	KIT ACC QLn4/ZQ630 SOFT CASE (Includes Shoulder Strap)
P1050667-018	KIT ACC QLn4/ZQ63 -EC AC ADAPTER US (type A) CORD

Getting Started

Part Number	Description
P1050667-019	KIT ACC QLn4/ZQ63-EC AC ADAPTER UK (type G) CORD
P1050667-020	KIT ACC QLn4/ZQ63-EC AC ADAPTER EU/CHILE (type C) CORD
P1050667-021	KIT ACC QLn4/ZQ63-EC, AC ADAPTER, JAPAN CORD
P1050667-022	KIT ACC QLn4/ZQ6-EC AC ADAPTER BRAZIL CORD
P1050667-023	KIT ACC QLn4/ZQ63-EC AC ADAPTER ARGENTINA CORD
P1050667-024	KIT ACC QLn4/ZQ63-EC AC ADAPTER AUSTRALIA (type I) CORD
P1050667-025	KIT ACC QLn4/ZQ63-EC, AC ADAPTER,CN CORD
P1050667-026	KIT ACC QLn4/ZQ63-VC – 15V – 60V to 12V
P1050667-027	KIT ACC QLn4/ZQ63-EC, AC ADAPTER,TAIWAN CORD
P1050667-028	KIT ACC QLn4/ZQ63-EC AC ADAPTER, ISRAEL CORD
P1050667-029	KIT ACC QLn4/ZQ63-EC (NO ADAPTER, NO CORD)
P1050667-030	KIT ACC QLn4/ZQ63-VC (no adapter, no cord)
P1050667-031	KIT ACC QLn4/ZQ63 METAL BELT CLIP
P1050667-032	KIT ACC QLn4/ZQ63 Handi-Mount (compact, flexible RAM arm) with Base Plate
P1050667-033	KIT ACC QLn4/ZQ63 Handi-Mount (compact, flexible RAM arm) without Base Plate
P1050667-034	KIT ACC QLn4/ZQ63 ASSY HARD CASE W/METAL BELT CLIP
P1050667-035	KIT ACC QLn4/ZQ63 Mobile Mount for Forklifts (with U-arm bracket and fanfold bin)
P1050667-037	KIT ACC QLn4/ZQ63 MOBILE MOUNT PLATE
P1050667-038	KIT ACC QLn/ZQ6 DESKTOP STAND
P1050667-041	KIT ACC QLn4/ZQ63 BATTERY ELIMINATOR NO ADAPTER
P1050667-047	KIT ACC QLn4/ZQ63 RAM MOUNT PLATE
P1031365-064	Kit ACC SC2 Li-ION SMART CHARGER, UK (type G) cord
P1031365-065	Kit ACC SC2 Li-ION SMART CHARGER, EU/CHILE (type C) cord
P1031365-066	Kit ACC SC2 Li-ION SMART CHARGER, AUSTRALIA (type I) cord
P1031365-067	Kit ACC SC2 Li-ION SMART CHARGER, BRAZIL
P1031365-068	Kit ACC SC2 Li-ION SMART CHARGER, CHINA CORD
P1031365-083	KIT ACC,QLn/ZQ5/ZQ6,AC ADAPTER, ARGENTINA CORD
P1031365-088	KIT ACC SC2 LI-ION SMART CHARGER, ISREAL CORD
P1031365-089	KIT,ACC,SC2 LI-ION SMART CHARGER,ARGENTINA CORD
P1031365-093	KIT ACC,QLn/ZQ5/ZQ6,AC ADAPTER,TAIWAN CORD

Part Number	Description
P1031365-094	KIT ACC,QLn/ZQ5/ZQ6,AC ADAPTER,JAPAN CORD
P1031365-095	KIT ACC SC2 LI-ION SMART CHARGER, TAIWAN CORD
P1031365-096	KIT ACC SC2 LI-ION SMART CHARGER, JAPAN CORD
SG-MPP-Q4HLSTR1-01	KIT,WAIST,STRAP,QLn420

Installing Drivers and Connecting to a Windows-Based Computer

To use your printer with a Microsoft Windows-based computer, you must first install the correct drivers.



IMPORTANT: You may connect your printer to your computer using any available connections. However, do not connect any cables from your computer to the printer until you are instructed to do so. If you connect them at the wrong time, your printer will not install the correct printer drivers. To recover from incorrect driver installation, see [What to Do If You Forget to Install Printer Drivers First](#) on page 27.

Installing the Drivers

Follow these steps to install the correct drivers.

1. Navigate to zebra.com/drivers.
2. Click **Printers**.
3. Select your printer model.
4. On the printer product page, click **Drivers**.
5. Download the appropriate driver for Windows.

The driver executable file (such as `zd86423827-certified.exe`) is added to your Download folder.

6. Run the executable file and follow the prompts.

When the setup is complete, you may add specific printers (see [Running the Printer Installation Wizard](#)).

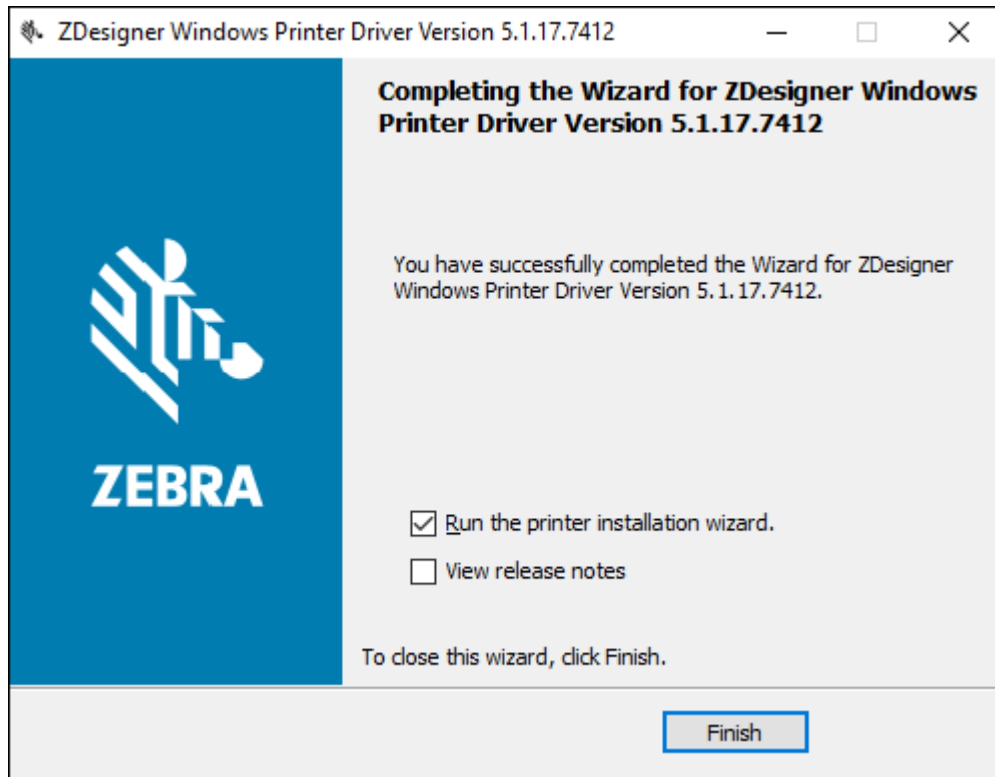

What to Do If You Forget to Install Printer Drivers First

If you plug in your Zebra printer before installing the drivers, the printer displays as an Unspecified device.

1. Follow the instructions in [Installing Drivers and Connecting to a Windows-Based Computer](#) on page 26 to download and install the drivers.
2. Right-click on the Windows menu and select Device Manager.
 - Alternatively, enter Device Manager in the Windows search bar located in the Taskbar.

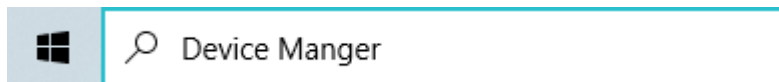

3. Click **Devices and Printers**.

In the following example, the ZQ220 Plus is an incorrectly installed Zebra printer.
4. Find **Printers** from the list and select the arrow to expand the list.

5. Right-click on ZDesigner ZQ220 Plus (CPCL) to open the menu.

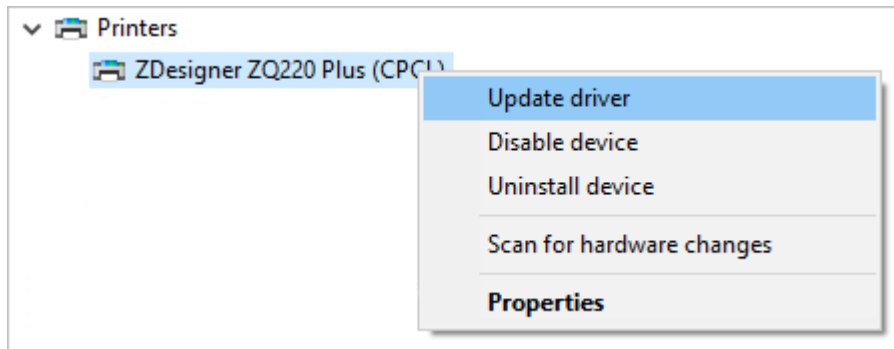

6. Click **Update Driver**.

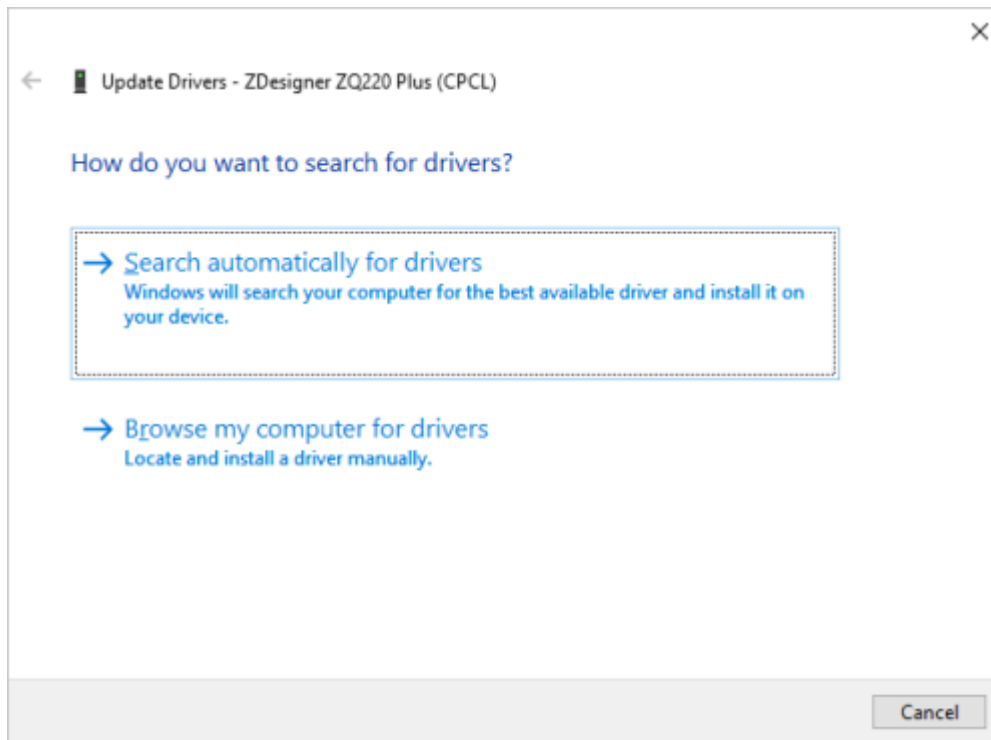

7. Click **Browse my computer for driver software**.
8. Click **Browse...** and navigate to the Downloads folder.

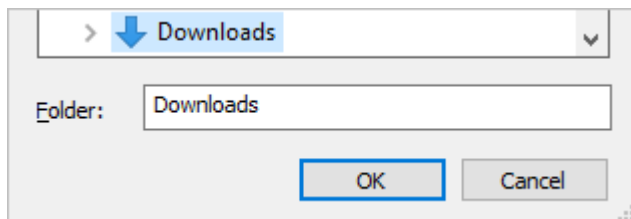

9. Click **OK** to select the folder.

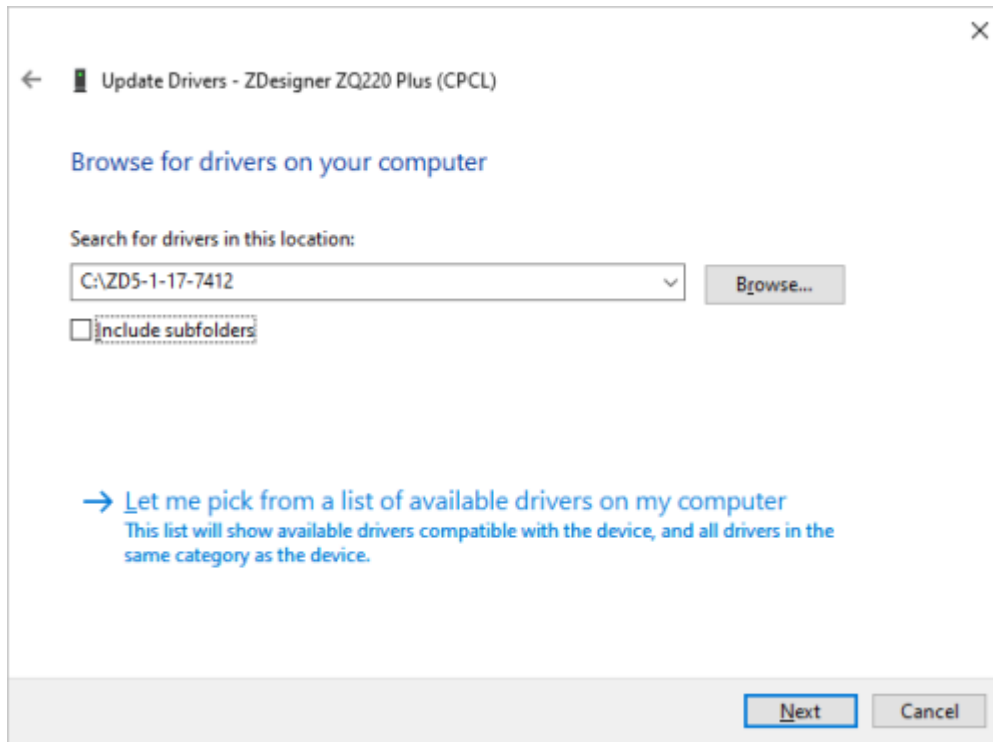

10. Click **Next**.

The device is updated with the correct drivers.

Zebra Setup Utilities

Before configuring your printer for use on a Local Area Network (LAN), you need some basic information that allows you to establish the network configuration for your printer. Zebra Setup Utilities (ZSU) provides a quick and easy way to configure your printers for various purposes, including setting them up for wireless communications either on a Local Area Network (LAN) or using the international Bluetooth communications standard.

Once Zebra Setup Utilities is downloaded to your computer, attach the USB cable to the printer and computer (go to [Cable Communication](#) on page 37).

Go to zebra.com/support to download Zebra Setup Utilities.

Adding a Printer through Zebra Setup Utilities

If desired, use Zebra Setup Utilities to add printers to Windows using this procedure, after installing the drivers.

1. If necessary, install the Zebra Setup Utilities program.
 - a) Go to zebra.com/setup and download Zebra Setup Utilities for Windows.
 - b) Run the `zsu-xxxxxxx.exe` file that you downloaded.
 - c) Follow the prompts in the InstallAware Wizard.
 - d) In the final screen of the wizard, click the checkbox next to **Run Zebra Setup Utilities now**, and then click **Finish**.
 - e) Follow the prompts in the System Prepare Wizard.
2. If necessary, open the **Zebra Setup Utilities** program.

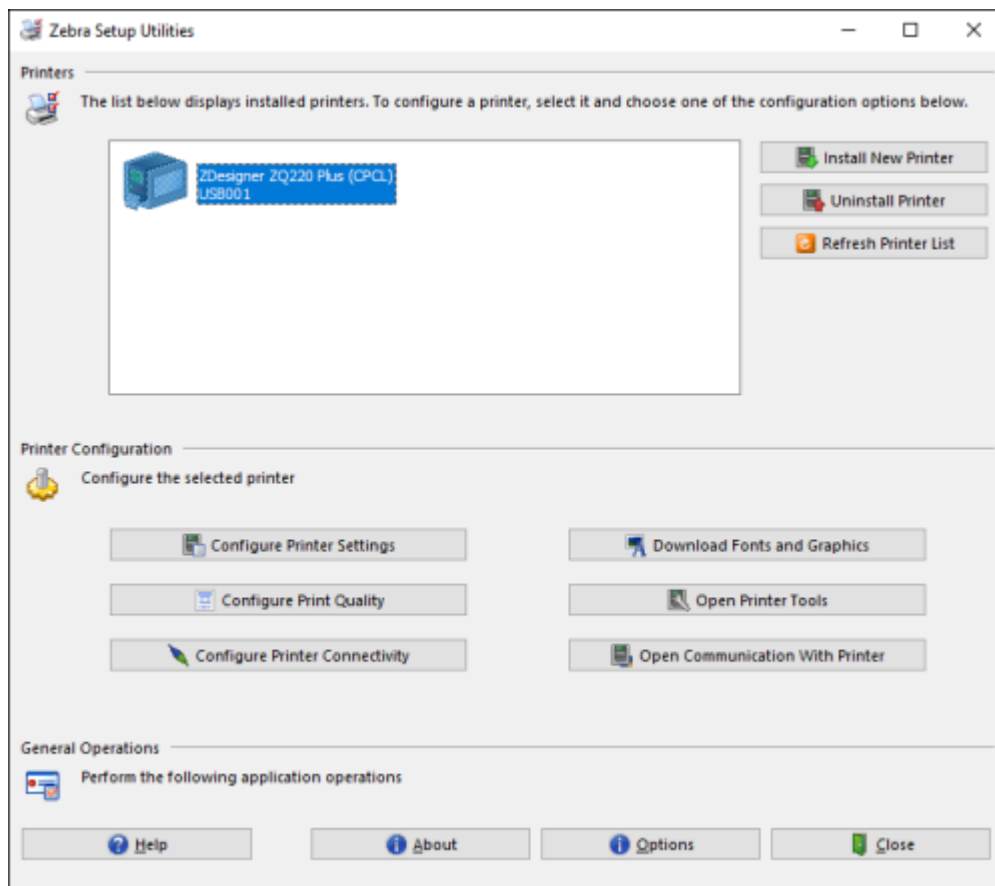

3. Click **Install New Printer**.

The printer driver wizard displays.

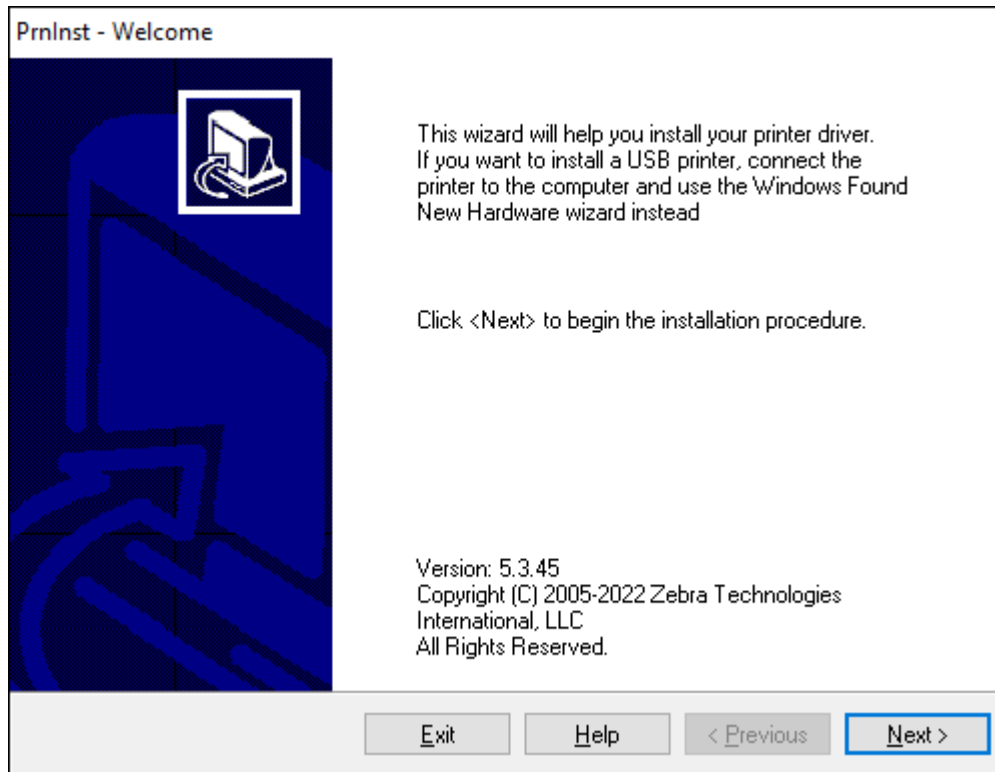

4. Click **Next**.

You are prompted to select an installation option.

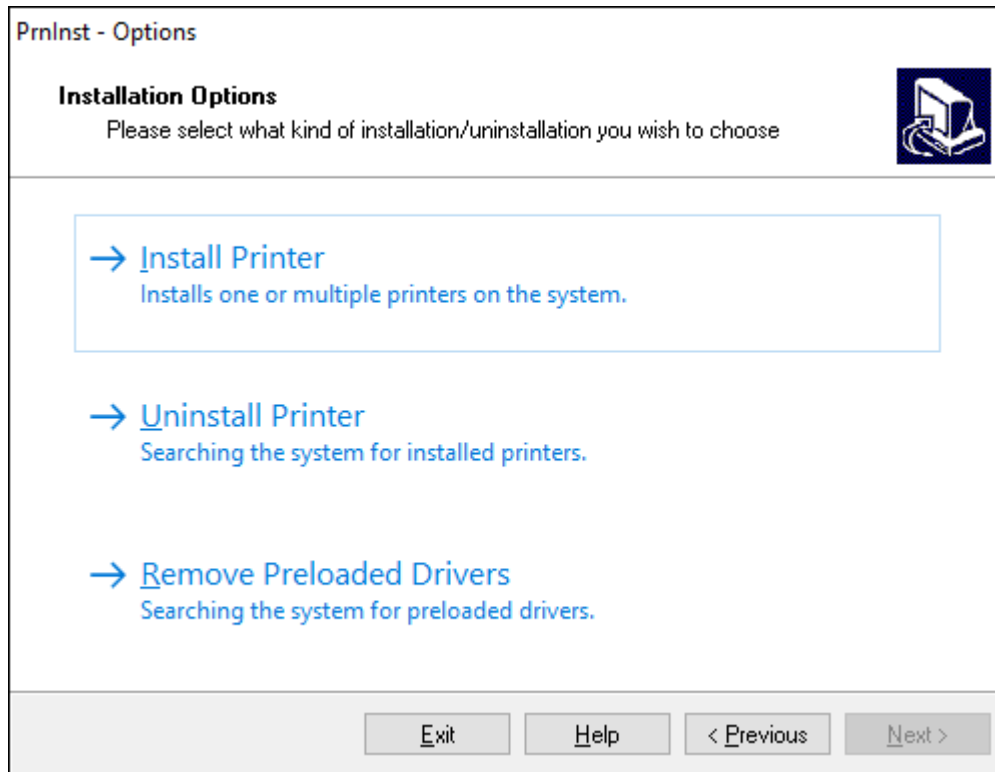

5. Click **Install Printer**.

You are prompted to select a printer type. The model type is located on top of the printer next to the tear bar, or on the part sticker located underneath the printer.

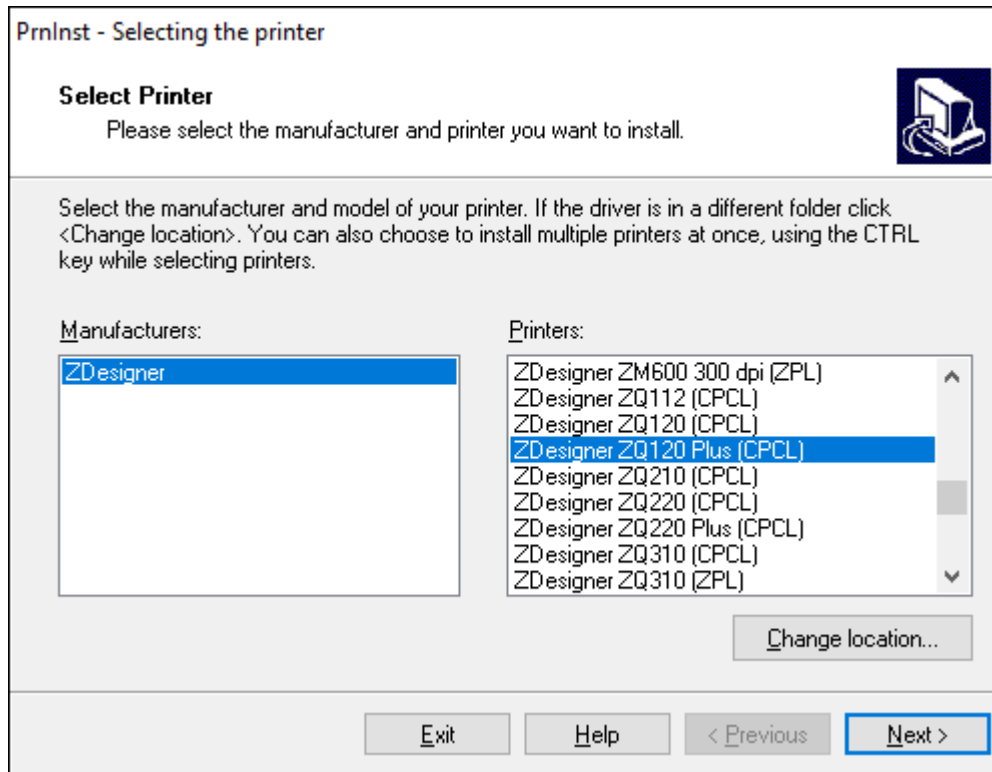

6. Click **Next**.

You are notified that the printer is already installed.

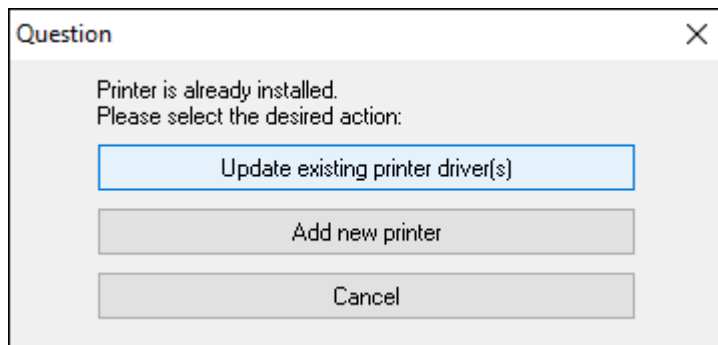

7. Click **Add new printer**.

You are prompted for a printer name, the port to which the printer will be connected, and the language for the printer display. Click **USB001**.

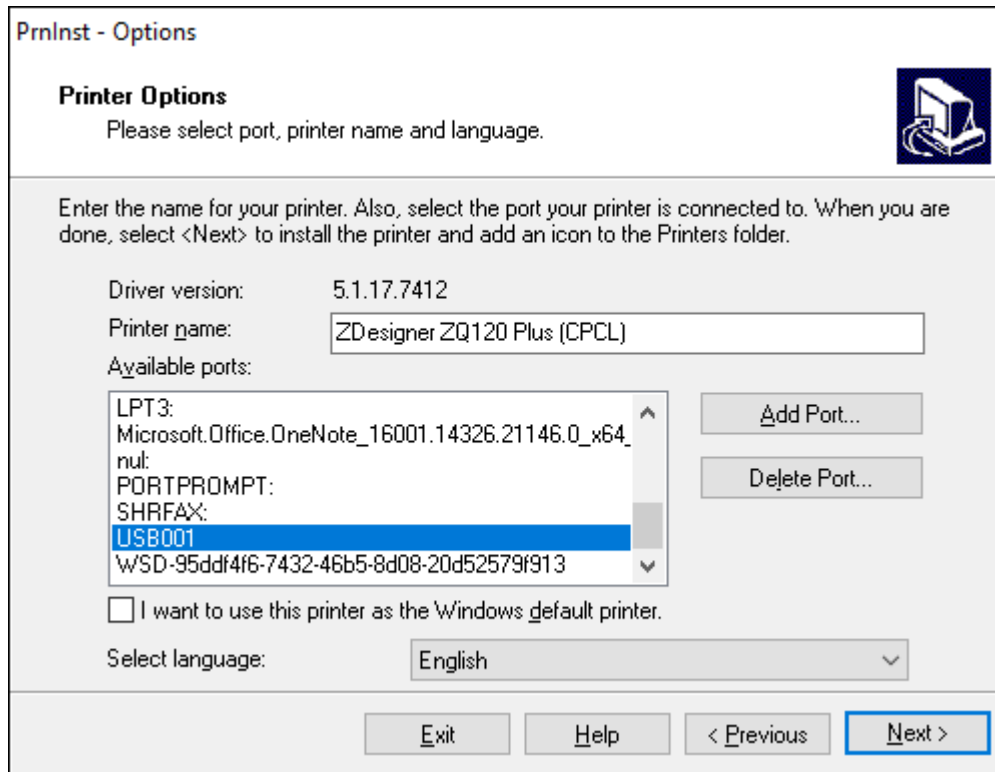

PrnInst - Options

Printer Options
Please select port, printer name and language.

Enter the name for your printer. Also, select the port your printer is connected to. When you are done, select <Next> to install the printer and add an icon to the Printers folder.

Driver version: 5.1.17.7412

Printer name: ZDesigner ZQ120 Plus (CPCL)

Available ports:

- LPT3:
- Microsoft.Office.OneNote_16001.14326.21146.0_x64_nul:
- PORTPROMPT:
- SHRFAX:
- USB001**
- WSD-95ddf4f6-7432-46b5-8d08-20d52579f913

I want to use this printer as the Windows default printer.

Select language: English

Exit Help < Previous **Next >**

8. Click **Next**.

You are prompted to launch other setup wizards.

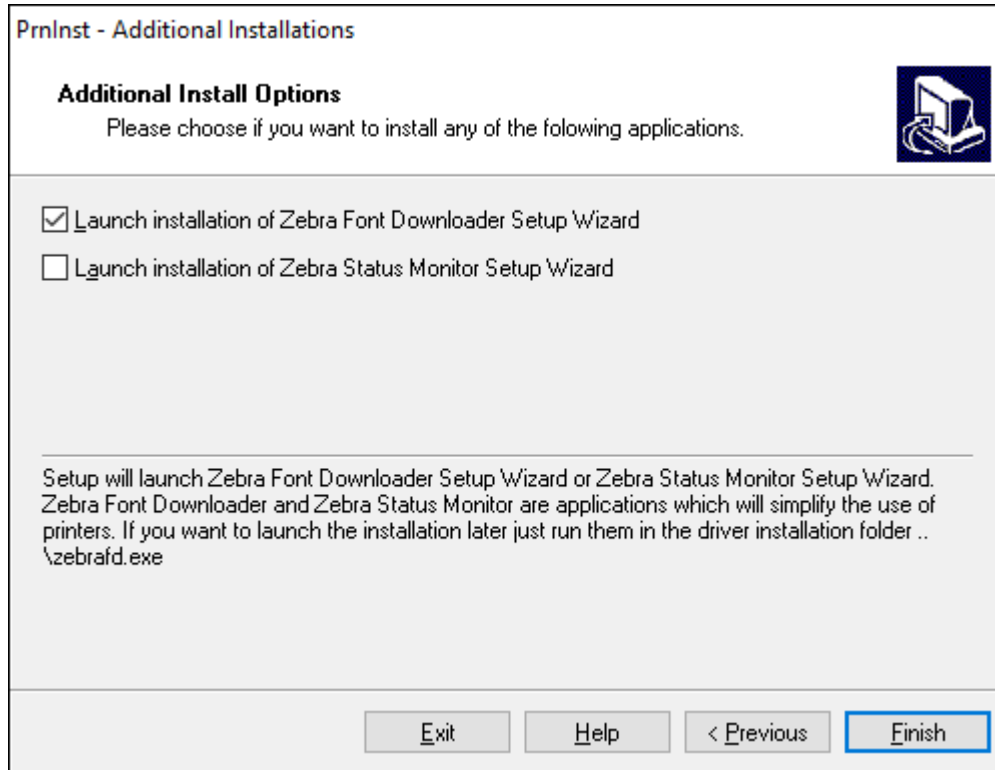

9. Check the desired options, and then click **Finish**.

The printer driver is installed. If you are prompted that other programs might be affected, click the appropriate option to continue.

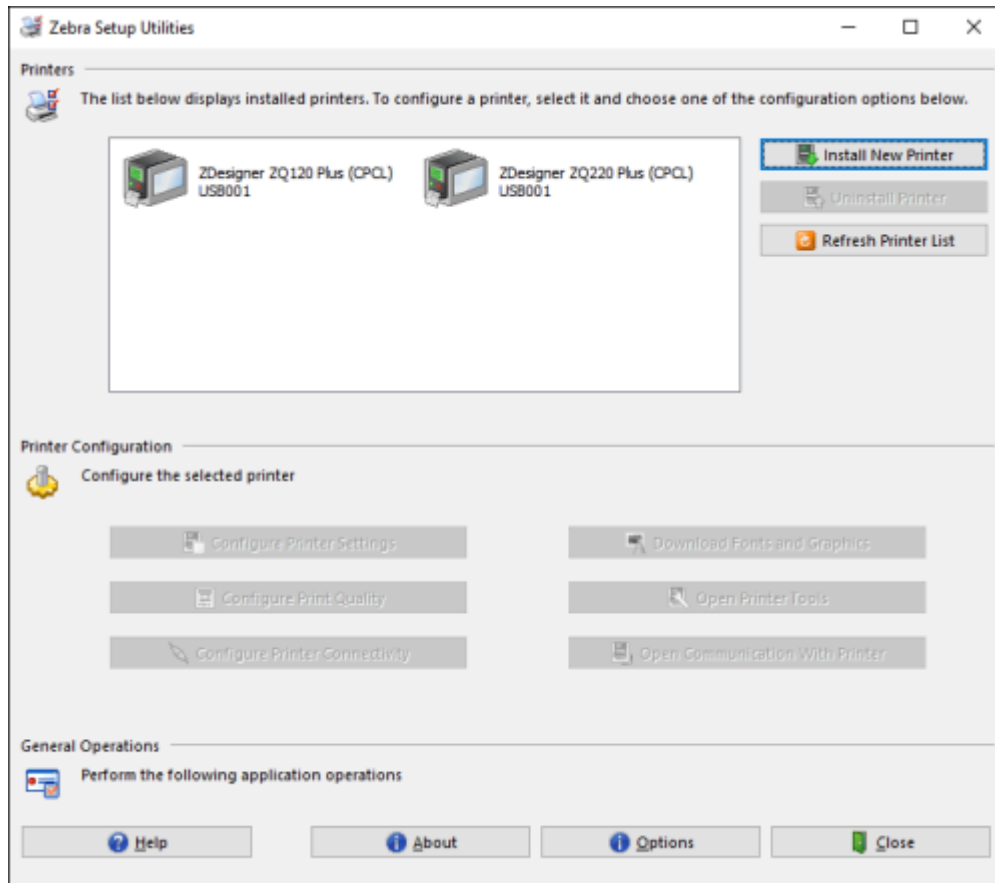

Cable Connection

- By cable via either RS-232C or USB 2.0. Windows drivers supporting printing via Serial, USB, and the network are included in the Zebra Designer Driver, which can be downloaded from zebra.com/drivers.
- By means of a wireless LAN (Local Area Network) per 802.11 specifications (optional).
- By means of the Ethernet when docked on the Ethernet cradle.
- By means of a Bluetooth short-range radio frequency link.

WinMobile®, Blackberry®, and Android devices use standard Bluetooth protocol.

The ZQ600 Plus Series printers are compatible with iOS devices. Therefore, printing via Bluetooth to an Apple device is possible.



Cable Communication

The ZQ600 Plus Series printers can communicate by cable. The specific cable supplied with your printer varies with the host device and your model printer.



NOTE: The printer should be turned off before connecting or disconnecting a communications cable.

Figure 11 Communications Cable

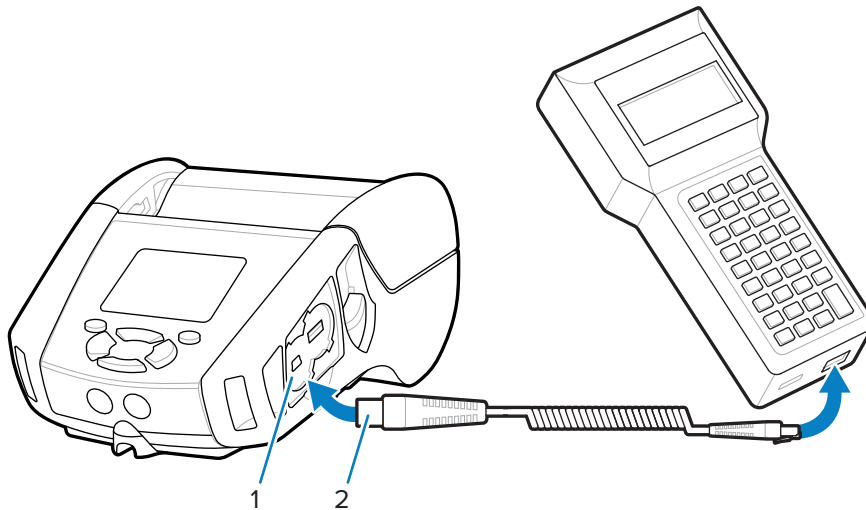

1	Communications port
2	Communications cable

RS-232C

The 14-pin serial connector on your communications cable plugs into the serial communications port on the side of the printer.

USB Communications

The ZQ600 Plus Series printers also have a USB port. The 5-pin connector on the USB cable plugs into the printer. The connectors are keyed to ensure correct alignment; do not try to force the cable if it does not plug in. The other end of the cable must be plugged into the mobile computer or into a serial or USB port on a computer. The ZQ600 Plus Series printers are configured with the USB Open HCI interface driver, allowing them to communicate with Windows-based devices.

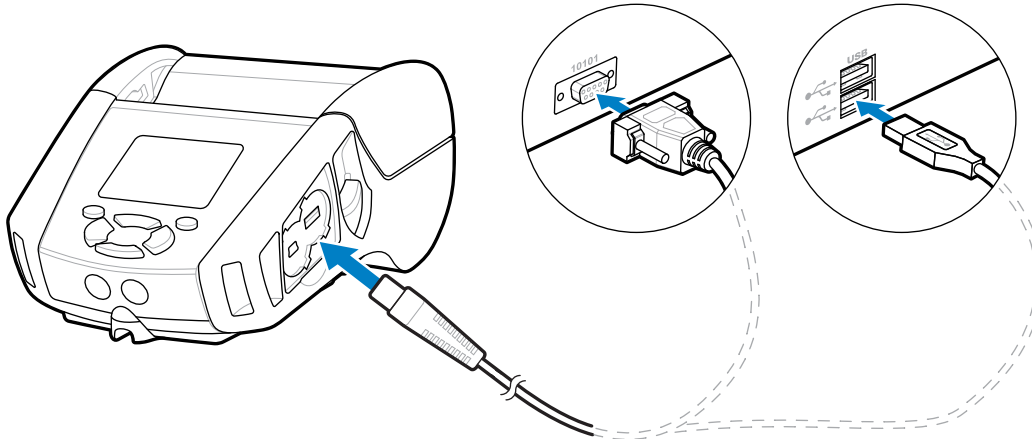
Figure 12 RS-232C or USB Communications Cable to Computer

Zebra Designer Driver uses Windows drivers that support printing via Serial, USB, and the network. Mobile computers and other communication devices may require installing special drivers to use the USB connection. Go to zebra.com/support for further details.

Providing Strain Relief for Communication Cables

Locking communication cables in place provides strain relief and prevents the cable from disconnecting from the printer. To connect either a USB or RS-232 communications cable to the printer permanently:

1. Access the communications port on the side of the printer next to the latch release lever.
2. Plug the connector into the appropriate port and align the plastic locking cap with the cutouts.

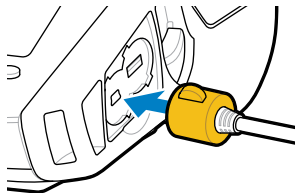

3. Rotate the locking cap clockwise to lock the cable in place. (Rotate counterclockwise to unlock the cable.)

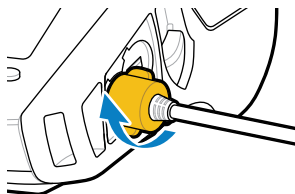

The cable is locked in place.



NOTE: Only one cable can be present in the USB/RS-232 communications port at a time for strain relief purposes.

Using Batteries

The ZQ600 Plus Series printers use a Li-Ion battery pack with integrated intelligence and data storage capabilities meeting Power Precision+ (PP+) functionality. The ZQ610 Plus and ZQ620 Plus use a 2-cell battery pack, and the ZQ630 Plus uses a 4-cell battery pack. This intelligent battery collects real-time battery metrics to maximize battery life and ensure every battery is healthy and can hold a full charge. The intelligent battery tracks and maintains the metrics required to provide real-time visibility into more meaningful battery statistics, such as total cycle usage of the battery, whether the battery is old and should be retired, or how long it takes a battery to fully charge.

Printer	Operating Temperature	Charging Temperature	Storage Temperature
ZQ610 Plus	-20 to 60°C	0–40°C	-25 to 60°C
ZQ620 Plus	(-4 to 140°F)	(32–104°F)	(-13 to 140°F)
ZQ610 Plus-HC ZQ620 Plus-HC	0–50°C (32–122°F)		
ZQ630 Plus	-20 to 50°C (-4 to 122°F)	0–40°C (32–104°F)	-25 to 65°C (-13 to 149°F)



IMPORTANT:

- For optimal charging results, only use Zebra smart battery packs.
- Charge batteries at room temperature with the device powered off.
- Ideal charging conditions are within 5-40°C (41-104°F).
- The device consistently performs battery charging in a safe and intelligent manner. At higher temperatures, the device may intermittently enable and disable battery charging for brief periods to maintain the battery within acceptable temperature limits. In the presence of abnormal temperatures, the device utilizes LED indicators and displays alerts to notify you when charging cannot be initiated.

The smart battery's health has three states: Good, Replace, and Poor. The printer's ability to function is contingent upon battery health, which is communicated to you through the display interface.

Number of Charge Cycles	Health	Power-Up Message
Less than 300	Good	None
300 to 599	Replace	Battery Diminished, Consider Replacing*
550 to 599	Replace	Warning-Battery Is Past Useful Life*
600 or more	Poor	Replace Battery, Shutting Down**

* Warning accompanied by one long beep.

** Warning flashes on and off, accompanied by a beep once every second. After 30 seconds, the printer shuts down.

Battery Safety



CAUTION: Avoid accidental short-circuiting of any battery. Allowing battery terminals to contact conductive material will create a short circuit which could cause burns and other injuries or could start a fire.



IMPORTANT: Always dispose of used batteries properly.



CAUTION—PRODUCT DAMAGE: Use of any charger not approved specifically by Zebra for use with its batteries could cause damage to the battery pack or the printer and will void the warranty.



CAUTION: Do not incinerate, disassemble, short circuit, or expose to temperatures above 65°C (149°F).

Extending Battery Life

- Never expose the battery to direct sunlight or temperatures over 40°C (104°F) when charging.
- Always use a Zebra charger designed specifically for Lithium-Ion batteries. Any other kind of charger may damage the battery.
- Use the correct media for your printing requirements. An authorized Zebra reseller can help you determine the optimum media for your application.
- If you print the same text or graphic on every label, consider using a pre-printed label.
- Choose the correct print darkness and print speed for your media.
- Use software handshaking (XON/XOFF) whenever possible.
- Remove the battery if the printer is not used for a day or more, and if you are not performing a maintenance charge.
- Consider purchasing an extra battery.
- Remember that any rechargeable battery loses its ability to maintain a charge over time. It can only be recharged a finite number of times before it must be replaced. Always dispose of batteries properly (go to [Product and Battery Recycling](#)).

Removing the Battery

This section describes how to remove the battery from the printer.



NOTE: Batteries are shipped in Sleep mode to preserve their maximum capacity while in storage prior to initial use.

1. If a belt clip is present on the bottom of the printer, do one of the following:
 - Rotate the clip to provide clearance for the battery.
 - Remove the belt clip completely.

2. Depress the latch on the battery pack (where indicated).

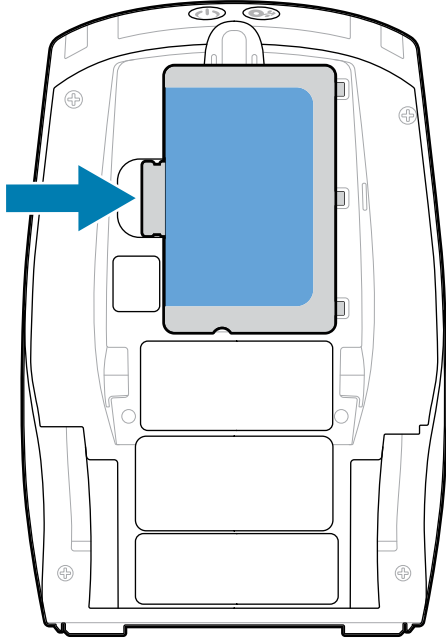

3. Rotate the pack away from the battery well, and then lift the battery up and out of the printer.

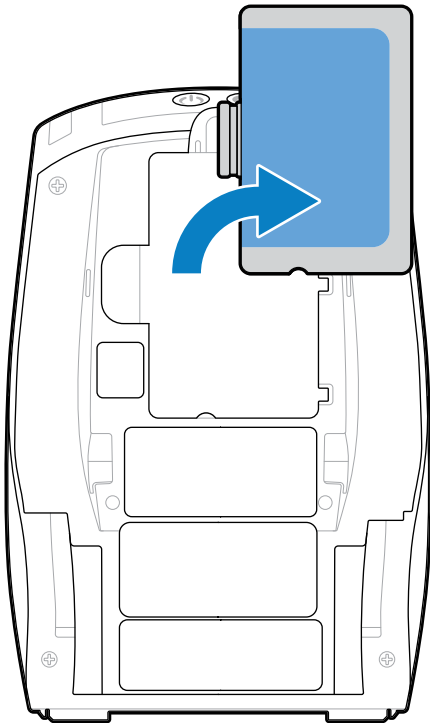

Removing the Battery Tape Insulator

This section describes how to remove the battery tape insulator.

1. Pull up on the tape insulator tab located on the bottom of the battery pack.

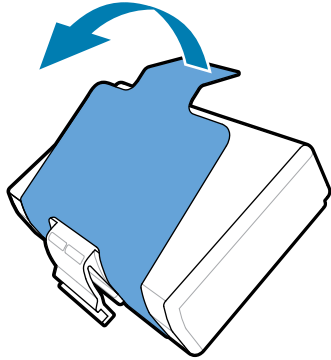

2. Peel back the tape insulator and remove it from the top of the battery pack. Discard upon removal.

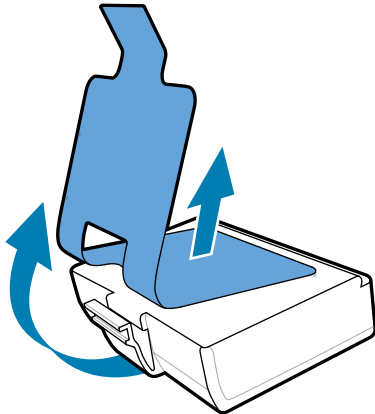

NOTE: The battery can explode, leak, or catch fire if improperly charged or exposed to high temperatures. Do not disassemble, crush, puncture, short external contacts, or dispose in fire or water. Charge on a Zebra approved Lithium-Ion charger only.

Installing the Battery

This section provides instructions on how to properly install the battery.

1. Locate the battery compartment on the bottom of the printer.
2. Swivel the belt clip (if present) to access the battery compartment, or remove the belt clip completely.

3. Angle the battery pack and insert it into the battery compartment.

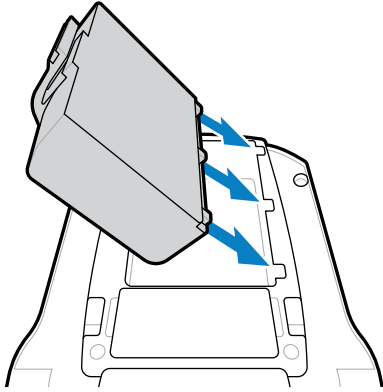

4. Rotate the battery into the compartment until it locks in place and is sitting flush with the printer.

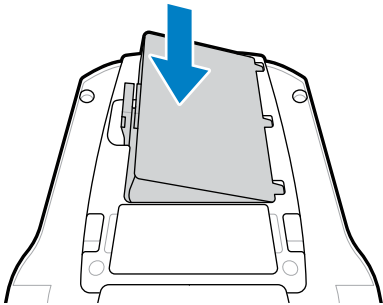

Battery Charging and Cradles

This section provides information on how to effectively manage and utilize the printer's battery, as well as details on compatible battery cradles for charging and storage purposes.

Charging the Battery

This section describes how to charge the battery using an AC Power Adapter.

1. Connect the appropriate AC power cord for your location to the adapter.

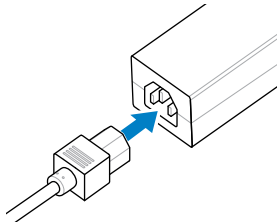

2. Open the protective cover on the printer to expose the DC input charger jack, and then plug the barrel plug from the AC adapter into the charger jack on the printer.

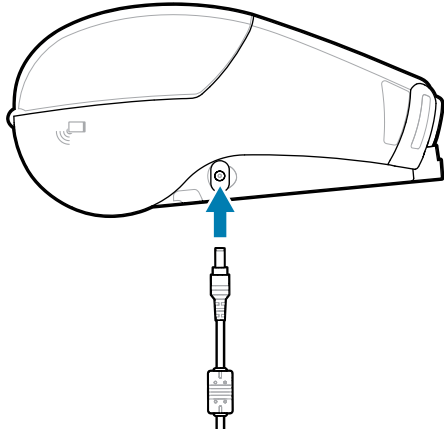

3. Plug the power cord into an electrical socket.

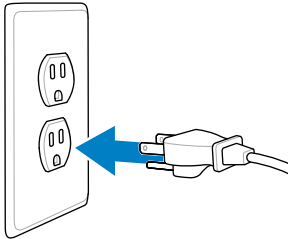

The printer powers up and begins charging. The printer can be left on or turned off at this point. Charging continues in either state.



IMPORTANT: While it is possible to charge the battery when using the printer, charge time increases under this condition.

Charger Safety



CAUTION-PRODUCT DAMAGE: Do not place any charger in locations where liquids or metallic objects may be dropped into the charging bays.

Smart Charger 2 - Single Battery Charger

The Smart Charger 2 (SC2) is a charging system utilized for the 2-cell and 4-cell lithium-ion smart batteries that power the ZQ610 Plus and ZQ620 Plus printers.

Figure 13 Smart Charger 2

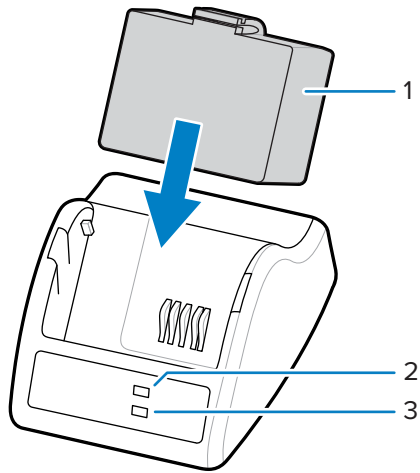

1	Smart Battery
2	Charge Status LED Indicator
3	Health Status LED Indicator

Smart Charger 2 Dimensions

Height	Width	Length
65.1 mm (2.56 in.)	101.5 mm (4 in.)	120.9 mm (4.75 in.)

Smart Charger 2 - Charging Status Indicators

The SC2 uses an LED indicator to indicate the charge state in either green, yellow, or amber as detailed below.

DC Power Input	Indicator	Battery Status
Present	Green	Battery not present
Present	Green	Fully charged
Present	Yellow	Charging
Present	Amber	Fault
Present	Off	Present and Battery Health = POOR

The battery charging icon  indicates the charging status. Charge time for all batteries is 2 hours.

Smart Charger 2 - Battery Health Indicator

The Smart Charger 2 features a tri-color (Yellow/Green/Amber) LED indicating the health of the battery pack. The battery health assessment begins when the battery is inserted into the charger, leading to the illumination of the corresponding LED as demonstrated. The LED will remain illuminated as long as input power is applied.

Battery	Indicator	Health Status
None or non-smart	Off	Not applicable
Smart battery present	Green	Good
Smart battery present	Yellow	Capacity diminished
Smart battery present	Flashing yellow	Past useful life
Smart battery present	Amber	Unusable - Replace (recycle battery)



NOTE: Refer to the Smart Charger 2 (SC2) for Mobile Printers User Guide for more information.

Quad Charger

The UCLI72-4 Quad Charger charges up to four 2-cell and 4-cell lithium-ion smart batteries used in the ZQ610 Plus and ZQ620 Plus printers.

Figure 14 Quad Charger

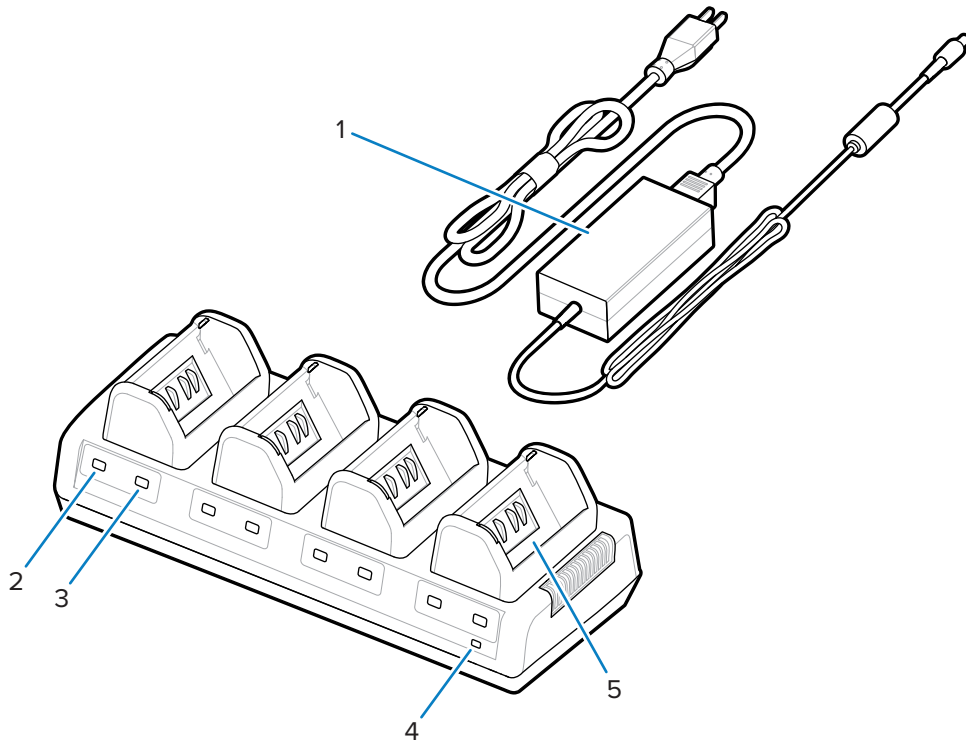

1	Power Supply
2	Amber Indicator
3	Green Indicator
4	Power Indicator
5	Charge Bay

Using the Quad Charger

1. Using the power supply, insert the barrel jack connector into the DC port on the printer and the power cord into an electrical outlet.
The power indicator light on the front panel turns on.
2. Insert the battery into any of the four charging bays in the orientation shown.

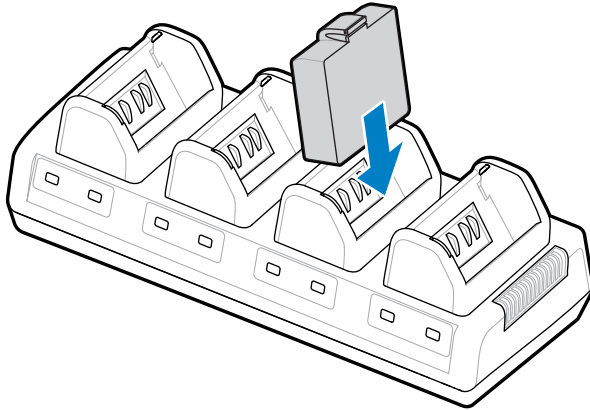

3. Rotate the battery into the compartment until it secures in place.

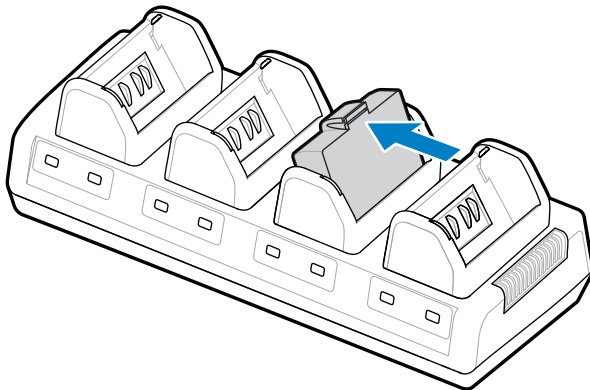

The amber indicator beneath the charging battery turns on when the battery is properly installed.

Quad Charger Status Indicators

Use the indicators located under the battery to monitor the charging process as outlined in the table.

Amber	Green	Battery Status
On	Off	Charging
On	Flashing	80% charged (OK to use)
Off	On	Fully charged
Flashing	Off	There is a fault. Replace the battery.



IMPORTANT: A fault condition is caused by a problem with the battery, typically when the battery is too hot or cold to charge reliably. Charge the battery when it is at the room's ambient temperature. If the amber indicator continues to flash, recycle the battery (go to [Product and Battery Recycling](#)).

Partially depleted battery packs require less time to fully charge. It is advisable to charge the battery completely before use to preserve battery life.



NOTE: For your safety, the Quad Charger stops charging batteries after 6 hours, regardless of the charge state. If your battery does not fully charge within that time, recycle the battery.



IMPORTANT: Do not block the ventilating slots on the top and bottom covers. Make sure to connect the charger to a power source that will not inadvertently shut off.

Ethernet and Charging Cradle

The ethernet cradle is an expansion base intended for use with the devices. A four-bay or single-bay cradle option is available for both the ZQ610 Plus and ZQ620 Plus, and a single-bay option specifically for the ZQ630 Plus. The cradles provide charging power to the docked printer and provide a standard 10/100 Mb/s ethernet port for communication to the printer. The cradles also supply battery charging power to the docked printer and act as a supplementary power source.

The cradles feature two LEDs indicating the status of the cradle:

- Solid green indicates when power is provided to the input of the cradle.
- Blinking green indicates ethernet activity.

The cradle allows you to dock the printer easily and remove it with the push of a button. The printer remains operable while docked; for example, the display is viewable, the charge LED status is viewable, and printer controls and data entry are available. The printer still prints while docked, and you can also replace the media.



NOTE:

- Remove the docking contacts cover on the bottom of the printer before docking the printer in the cradle.
- Clean the docking contacts with a Zebra cleaning pen to remove any residue left behind by the label.

LED Status Indicator

LED Status	Indication
Solid Green	Power On
Blinking Green	Ethernet Activity

4-Bay Ethernet Cradle (ZQ610 Plus/ZQ620 Plus)

The 4-Bay Ethernet Cradle provides charging and ethernet connectivity for the ZQ610 Plus and ZQ620 Plus.

Figure 15 4-Bay Ethernet Cradle

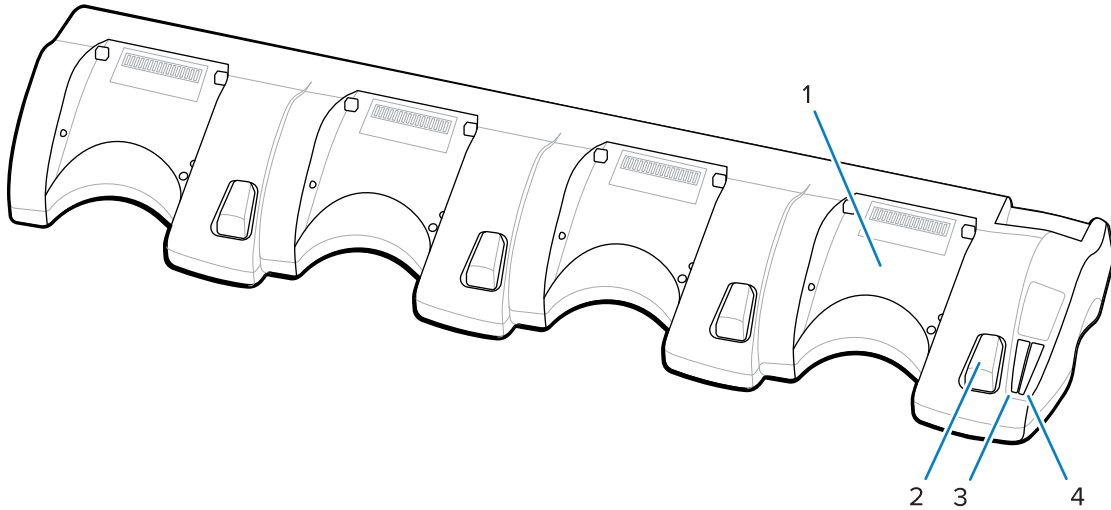

1	Docking Bay
2	Release Button
3	Ethernet Status Indicator
4	Power Status Indicator

4-Bay Ethernet Cradle Dimensions

Height	Width	Length
66.7 mm (2.62 in.)	579.99 mm (22.83 in.)	150.57 mm (5.93 in.)

Single-Bay Ethernet Cradle (ZQ610 Plus/ZQ620 Plus)

The Single-Bay Ethernet Cradle provides charging and ethernet connectivity for the ZQ610 Plus and ZQ620 Plus.

Figure 16 ZQ610 Plus/ZQ620 Plus Single-Bay Ethernet Cradle

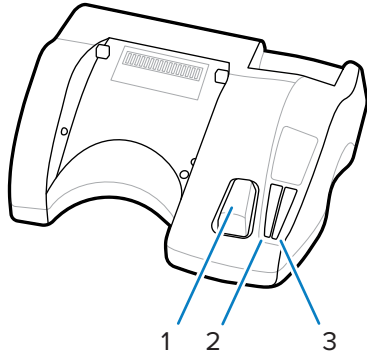

1	Release Button
2	Ethernet Status Indicator
3	Power Status Indicator

Single-Bay Ethernet Cradle Dimensions (ZQ610 Plus/ZQ620 Plus)

Cradle	Height	Width	Length
Single Bay Cradle	66.7 mm (2.62 in.)	171.28 mm (6.74 in.)	150.57 mm (5.93 in.)

ZQ630 Plus Single-Bay Ethernet Cradle

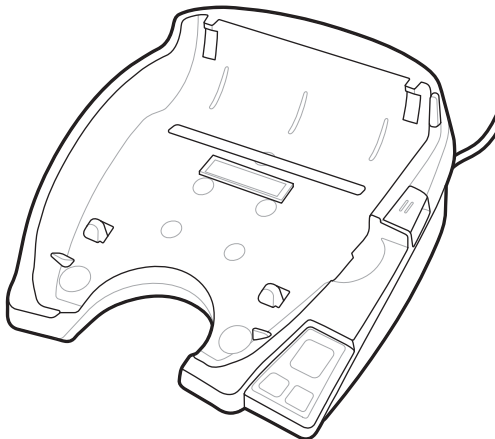

Height	Width	Length
66.2mm (2.6 in.)	200.6mm (7.9 in.)	219.61 mm (8.64 in.)

Printer Operation with Cradle

This section describes how the printer functions while placed within the cradle.

- The ZQ630 Plus printer charges when placed in its cradle.
- Docking the printer in the cradle automatically turns it on, ensuring it can be managed remotely.
- When the printer detects input power from the cradle and the presence of a live ethernet link, it automatically connects to the ethernet network.
- The Wi-Fi turns off when the ethernet link is active. It turns back on when the ethernet link is no longer active.
- The interface remains active for printers with a Bluetooth radio while the printer is in the cradle.
- The serial and USB ports remain active while the printer is in its cradle.
- The DC input barrel jack connector cannot be used while the printer is in the cradle. The DC barrel jack should be plugged directly into the cradle instead.



NOTE: The printer provides overvoltage protection, so no damage occurs when voltages from 0–36V are applied at the DC Power jack. If the voltage is greater than 36V, the DC line fuse permanently opens reducing a fire hazard. The battery only charges when 12VDC is applied using the Zebra AC adapter.

1-Slot Battery Charger

Use Case: Home Office/Small Business

The 1-Slot Battery Charger provides you with a single, spare battery charging solution. Similar to the 3-Slot Battery Charger, the single charger charges a 4-cell battery within 6 hours.

Figure 17 1-Slot Battery Charger

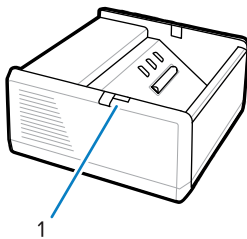

1	LED Indicator
---	---------------

3-Slot Battery Charger

Use Case: Settlement Room

The 3-Slot Battery Charger is a charging system for use with the ZQ600 Plus series batteries.

- It charges 2-cell lithium-ion batteries used in the ZQ610 Plus and ZQ620 plus.
- It charges 4-cell lithium-ion batteries used in the ZQ630 Plus.
- The 3-slot charger is capable of charging three 4-cell batteries simultaneously within 6 hours and three 2-cell batteries in less than four hours.
- It can either be used as a standalone charger or mounted on a 5-slot share cradle.



NOTE: For more information about accessories, go to zebra.com/zq600plus-info.

Figure 18 3-Slot Battery Charger

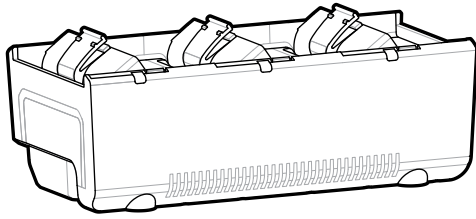

1- and 3-Slot Battery Charger Status Indicators

Both the 1-slot and 3-slot battery chargers use an LED indicator locator next to each slot to indicate the charge state in either green, red, or amber.

Charging Status Indicators

Mode	Charging Indication	Description
Charge Fault		Fast blinking red.
Charging (Healthy)		Solid amber
Charge Done (Healthy)		Solid green
Charging (Unhealthy)		Solid red
Charging Done (Unhealthy)		Solid red
Best Battery (Charging)		Alternates between solid and bright bursts of amber.
Best Battery (Charge Done)		Alternates between solid and bright bursts of green.

Loading Media

You can operate the ZQ600 Plus Series printers in one of two different modes: Tear-Off or Peel-Off. Tear-Off mode allows you to tear off each label (or a strip of labels) after it is printed. In Peel-Off mode, the backing material is peeled away from the label as it is printed. When printing batches, the next one is printed after you remove the label.

Loading Media in Tear-Off Mode

This procedure describes loading media in Tear-Off mode.

1. Open the printer.
 - a) Press the Latch Release button (1) on the side of the printer.
The media cover releases.
 - b) Rotate the media cover (2) backward completely, exposing the media compartment and adjustable media supports.

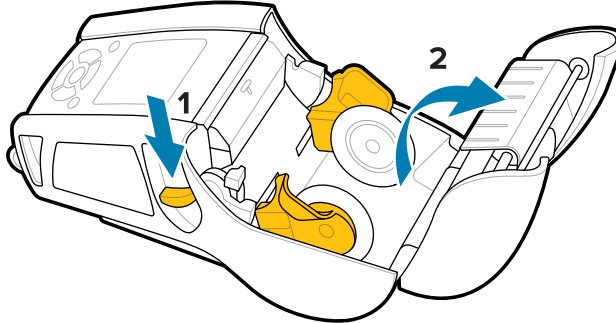

2. Pull the media supports apart and insert the roll of media between the supports in the orientation shown.

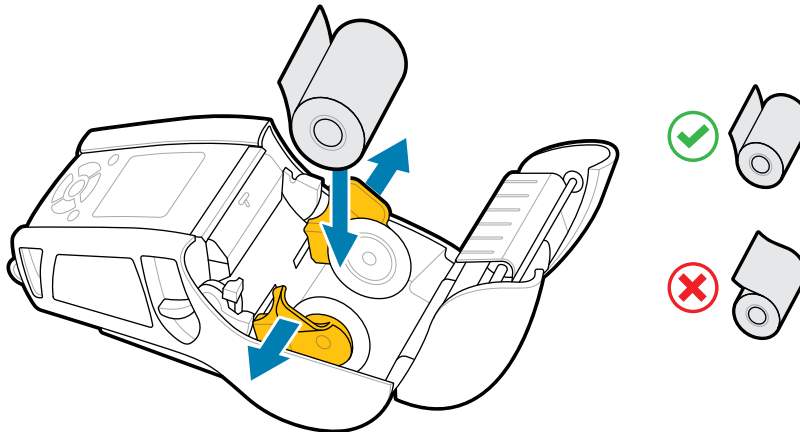

The supports secure the media in place and adjust to the width of the media. The media roll should be able to spin freely on the supports.

3. Close the media cover.

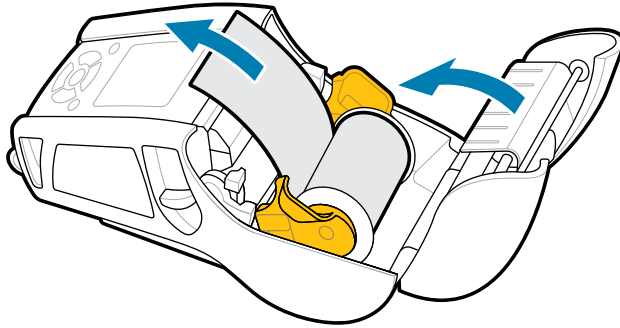

NOTE: Refer to the Programming Guide for information on changing the setting to adjust the media feed length via a Set-Get-Do (SGD).

Loading Media in Peel-Off Mode (ZQ610 Plus/ZQ620 Plus)

This section describes loading media into the ZQ610 Plus and ZQ620 Plus printers in Peel-Off Mode.

1. Peel a few labels off the backing.
2. Open the printer.
 - a) Press the latch release button (1) on the side of the printer.
The media cover releases.
 - b) Rotate the media cover (2) backward completely, exposing the media compartment and adjustable media supports.

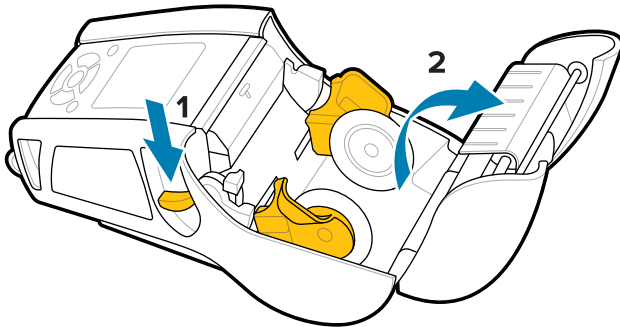

3. Pull the media supports apart and insert the roll of media between the supports in the orientation shown.

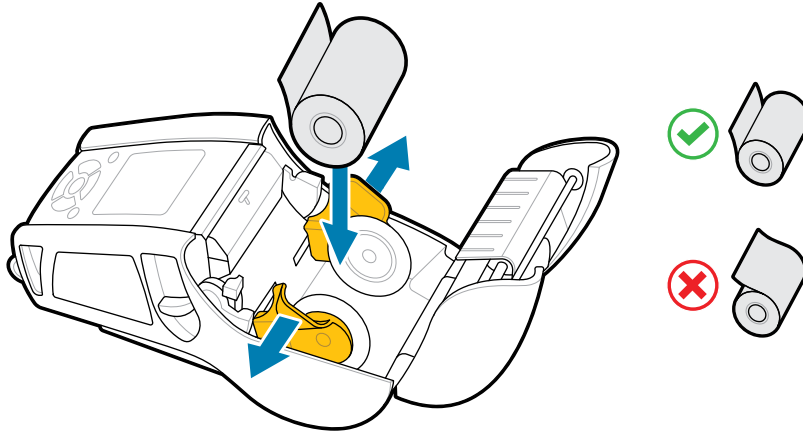

4. Push the peeler lever up to release the peeler bail into the up position.

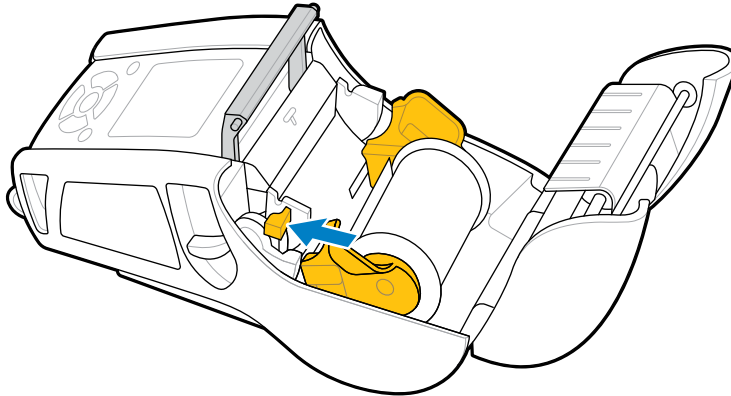

The media feeds toward the peeler bail.

5. Close the media cover.

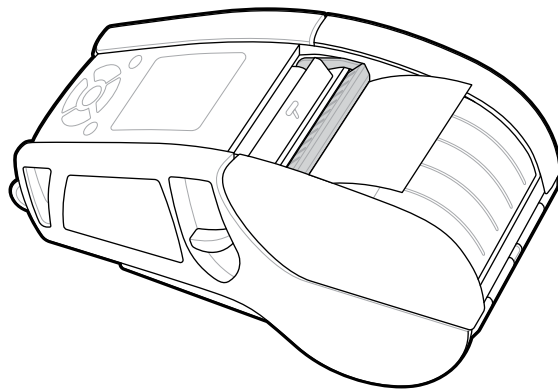

The peeler bail folds down. The printer is now primed to remove labels from the roll automatically.

6. Press **POWER** to turn on the device, or press **FEED** if the device is already on.

The printer advances the media to the next label if printing labels. If you print on journal media, the printer advances a short strip of media.

Disengaging the Peeler Bail

To disengage the peeler bail:

1. Open the media cover as previously described. The peeler bail automatically pops up.
2. Push the peeler bail down until it locks into place.

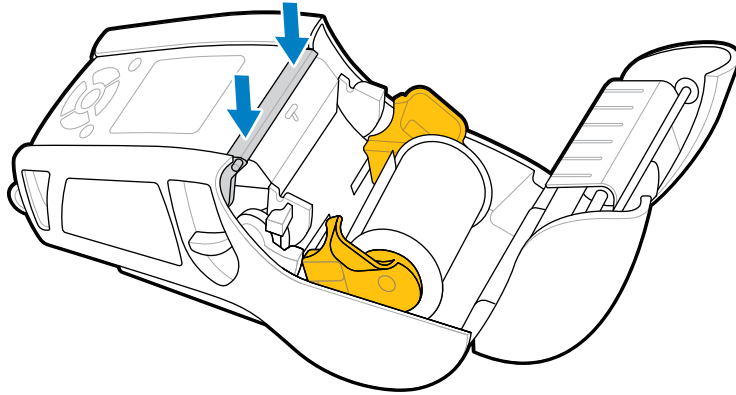

3. Close the media cover.

Loading Media in Peel-Off Mode (ZQ630 Plus)

This section describes loading media into the ZQ630 Plus printer in Peel-Off Mode.

1. Peel a few labels off the backing.
2. Open the printer.
 - a) Press the latch release button (1) on the side of the printer.
The media cover releases.
 - b) Rotate the media cover (2) backward completely, exposing the media compartment and adjustable media supports.

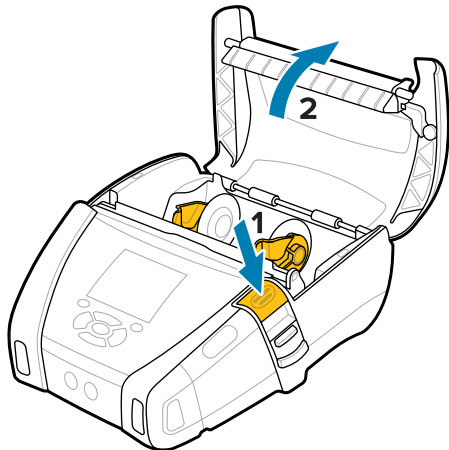

3. Pull the media supports apart and insert the roll of media between the supports in the orientation shown.

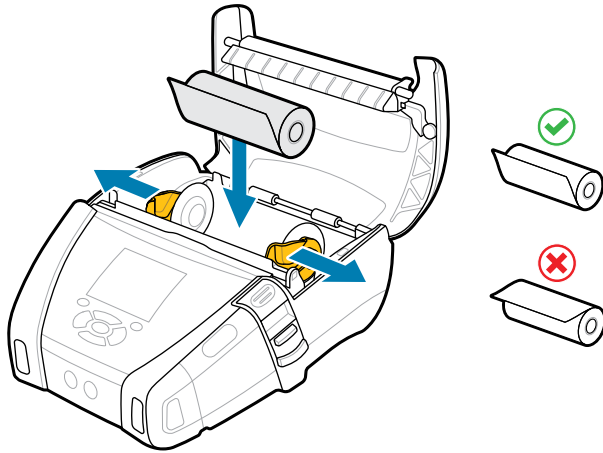

4. Close the media cover.

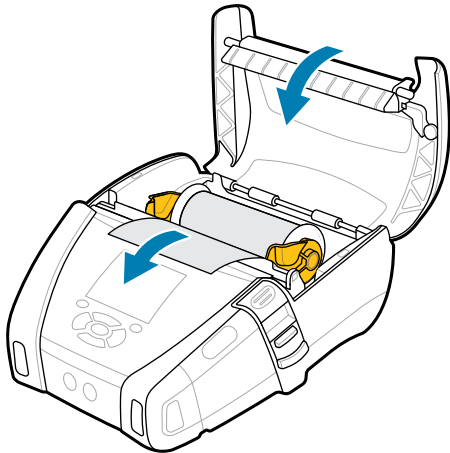

5. Pull the peeler lever up until it locks into place.

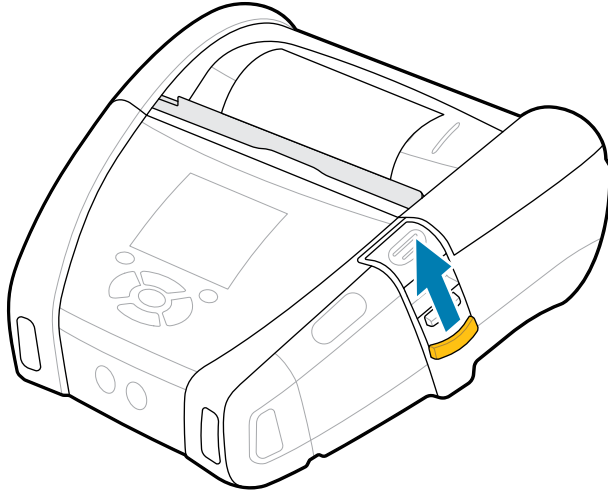

The peeler bail folds backward. The printer is now primed to remove labels from the roll automatically.

6. Press **POWER** to turn on the device, or press **FEED** if the device is already on.

The printer advances the media to the next label if printing labels. If you are printing on journal media, the printer advances a short strip of media.

Disengaging the Peeler Bail

To disengage the peeler bail, push the peeler bail button inward and then down.

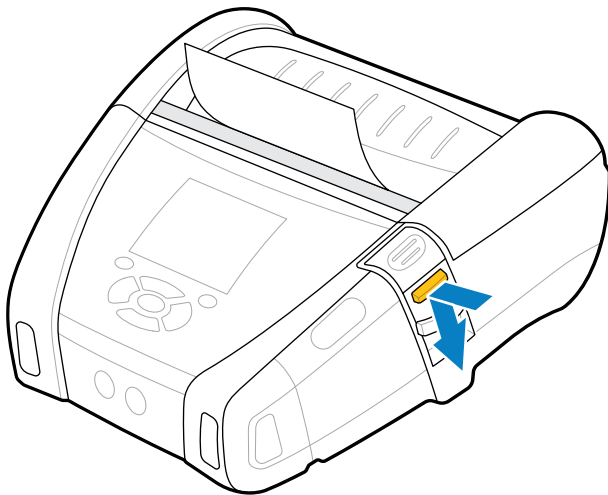

The peeler bail snaps forward to its original position and is now disengaged.

Printing a Test Label

Before connecting the printer to your computer or mobile computer, ensure the printer is in proper working order. Do this by printing a configuration label using the Two-Key method. Analyzing the information

on these labels can help you to troubleshoot potential issues. For more information, go to [Printing a Configuration Label](#) on page 110.

Wearing the Printer

Mobile printer accessories offer valuable features that enhance portability, making it easier to use the printer while on the go.

Swivel Belt Clip

The ZQ600 Plus Series printers come with a swivel belt clip.

Figure 19 Printer with the Belt Clip

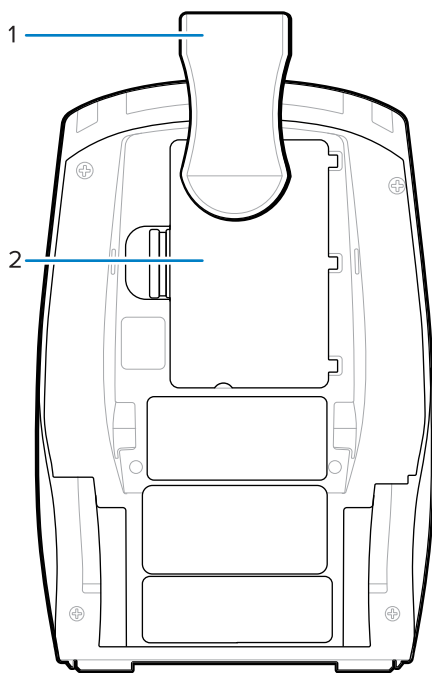

1	Belt Clip
2	Battery Pack

To use:

1. Remove the battery pack.
2. Insert the ball on the back of the belt clip into the socket at the bottom of the printer.
3. Insert the battery pack.
4. Hook the clip over your belt, ensuring the clip is securely attached to the belt.

The belt clip pivots, allowing you to move freely while wearing the printer.

Metal Belt Clip

The ZQ630 Plus printer provides an alternative metal belt clip option that offers increased sturdiness.

The clip is securely attached to the printer using two Philips pan head screws. It can also be used independently or in conjunction with the hard case. For more information, go to zebra.com/accessories.

Figure 20 Metal Belt Clip Without Hard Case

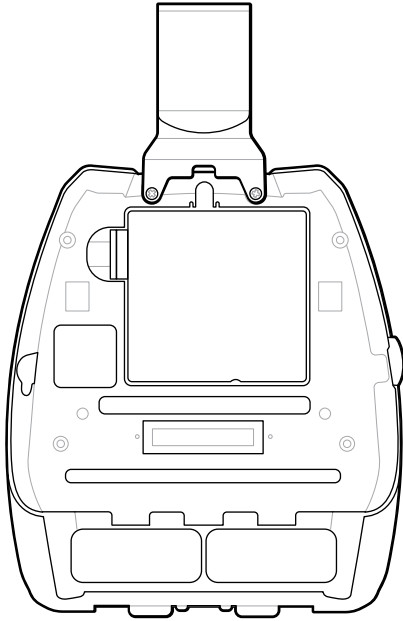
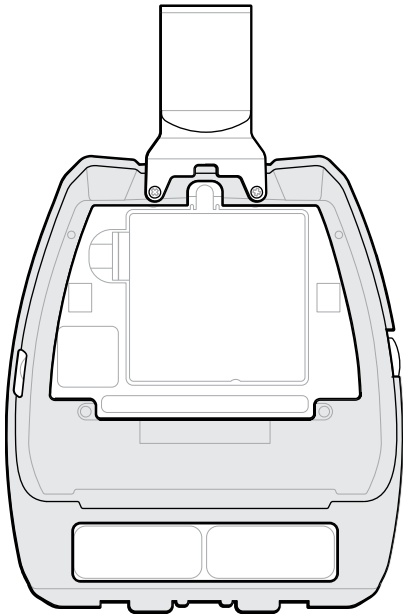

Figure 21 Metal Belt Clip with Hard Case



Adjustable Shoulder Strap

If your printer is equipped with the shoulder strap option, follow the instructions below on how to use it.

1. Pass the end of the shoulder strap through the strap slot on the printer's front side, and then loop it around the strap attachment point.

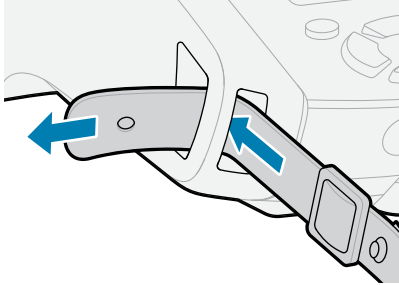

2. Insert the hole on the end of the strap over the metal fastener to secure it.

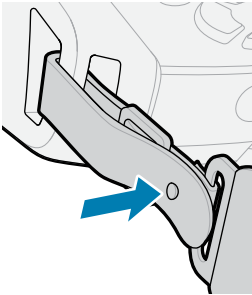

-
-
3. Repeat Steps 1 and 2 on the opposite side of the printer.

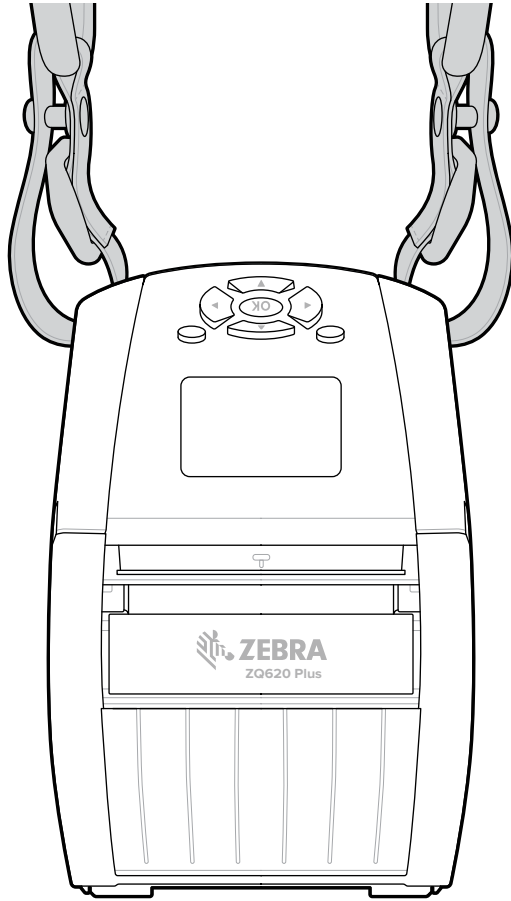

Soft Case

The ZQ600 Plus Series printers' soft case option allows you to carry the printer from your belt.

1. Lift up the top flap of the soft case, which is secured with a self-fastener.

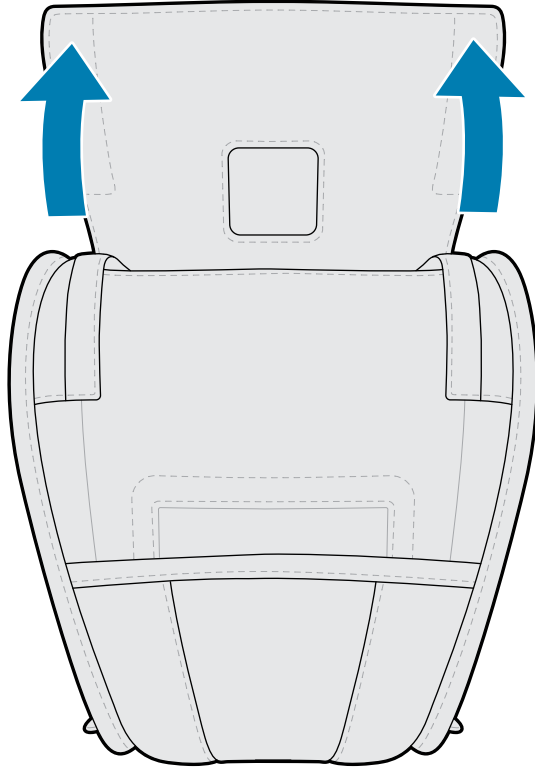

2. Slide the printer into the case so the LCD display is visible through the plastic window.

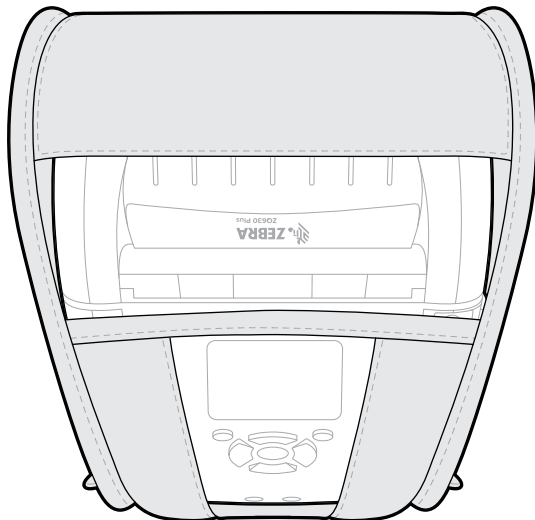

NOTE: The shoulder strap option can be used with the soft case by securing the ends of the shoulder strap on the two metal rings on the soft case.

Hand Strap

The ZQ600 Plus series printer hand strap accessory attaches to the printer's strap attachment point to provide you with a convenient and secure method of carrying the printer.

1. Insert the loop on the end of the strap through the strap slot on the front of the printer.

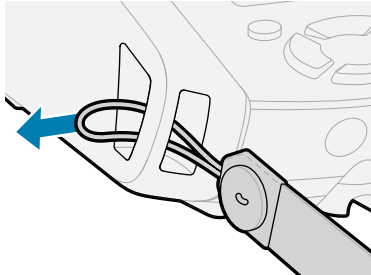

2. Loop the end of the strap back around the strap attachment point and secure it over the button.

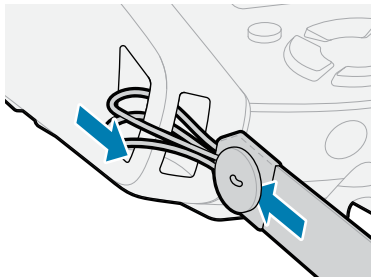

3. Repeat this process for the opposite end of the strap.

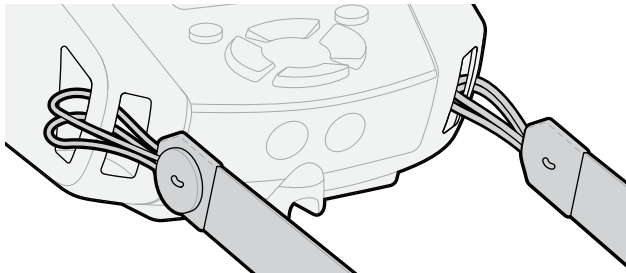

Hard Case

The ZQ630 Plus printer has a two-piece hard case option. It allows you to wear the printer from your belt with the metal belt clip (included) while also providing increased protection for the printer. The case opens and closes on a hinge located on the back. The metal belt clip is mounted to the hard case and printer with two screws. If no belt clip is used, two shorter screws are used to hold the printer to the hard case.

1. Insert the printer into the bottom half of the hard case shell.

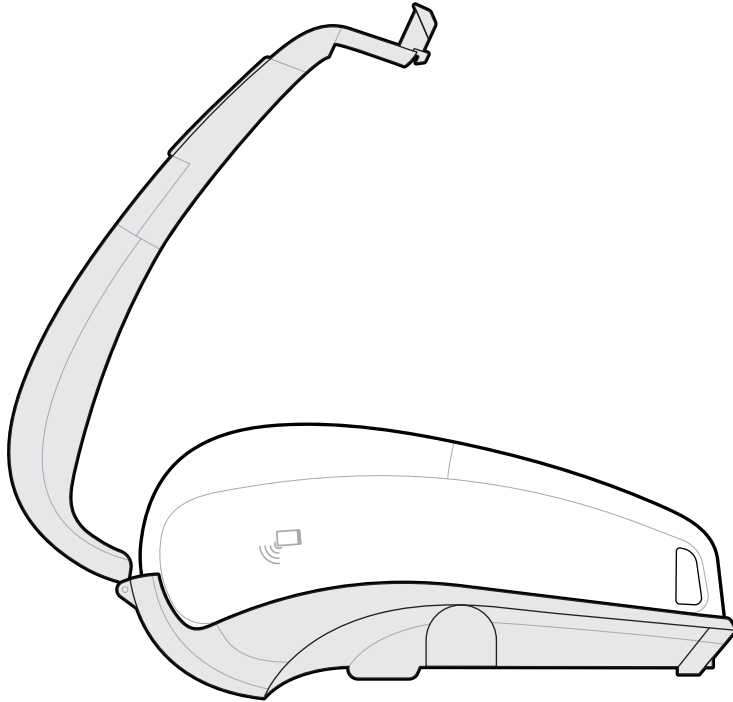

2. Rotate the top half of the hard case shell over the printer's top and snap shut.

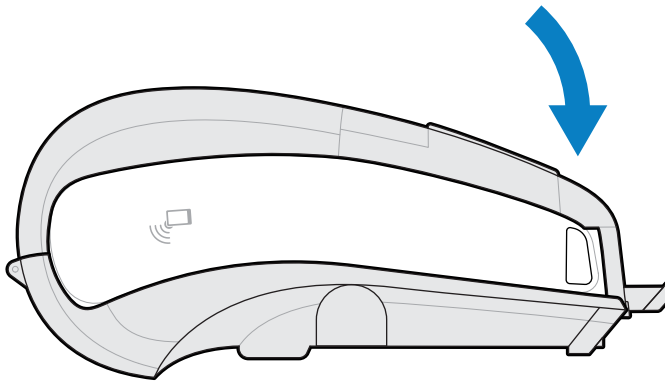

3. Use a #1 Phillips head driver to secure the two 6-32 x 5/8 screws to the bottom of the hard case.

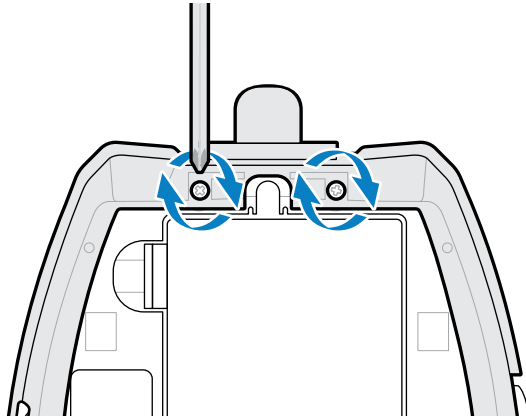

Waist Holster

The ZQ630 Plus printer has a waist holster option allowing you to carry the printer around your waist for easy access.

1. Unsnap the fastener on the waist strap.

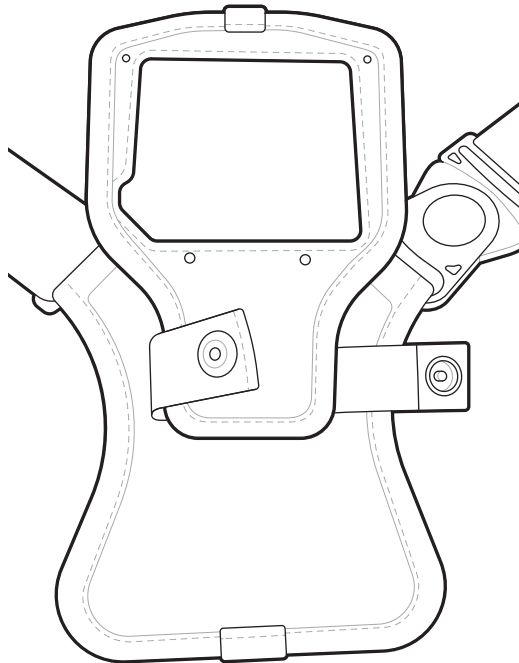

2. Unlock the male D swivel clip on the waist strap from the female D clip on the printer mount pad to remove it.

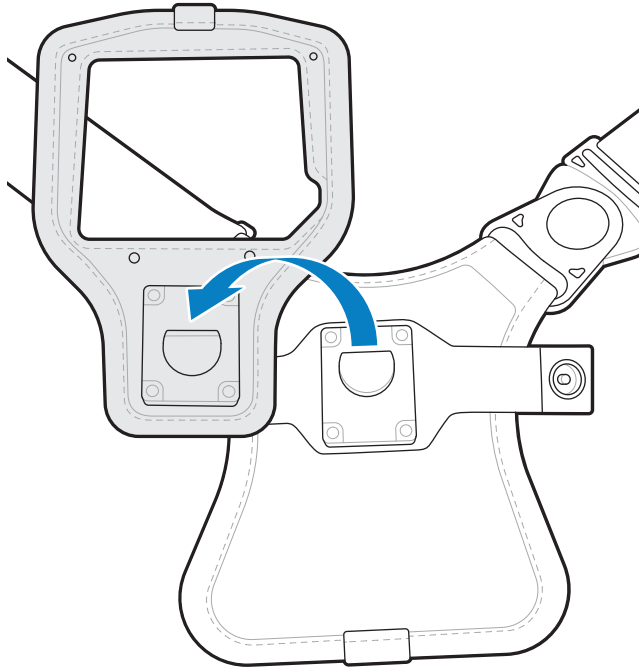

3. Align the holes on the mount pad with the mounting holes on the bottom of the printer (circled).

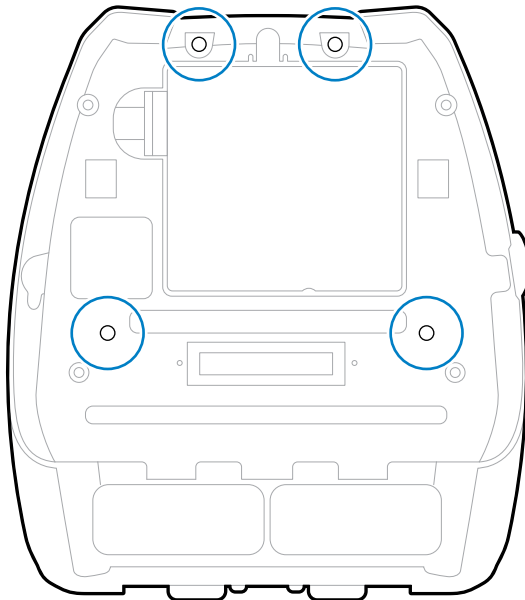

4. Use a 4mm hex driver on the two 6-32 x 0.375 in. screws and two #6 washers to attach the mount pad to the top of the printer (circled).

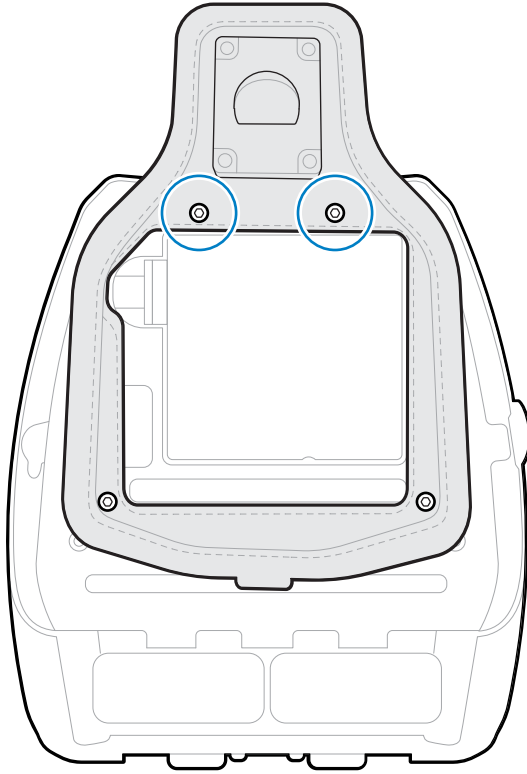

5. Attach the two 6-32 x 0.625 in. screws and washers to the bottom of the mount pad (circled).

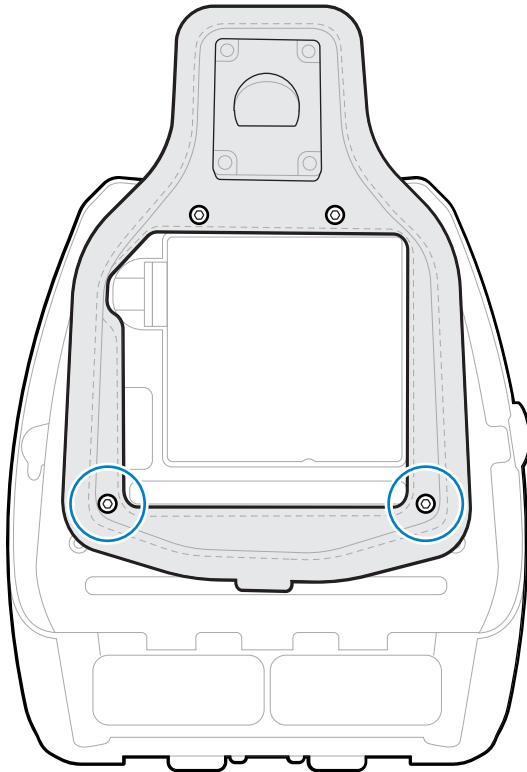

6. Connect the male D swivel clip on the waist strap to the female D clip on the printer mount pad.

7. Snap the fasteners to secure (opposite side), and then rotate the waist strap 180°.

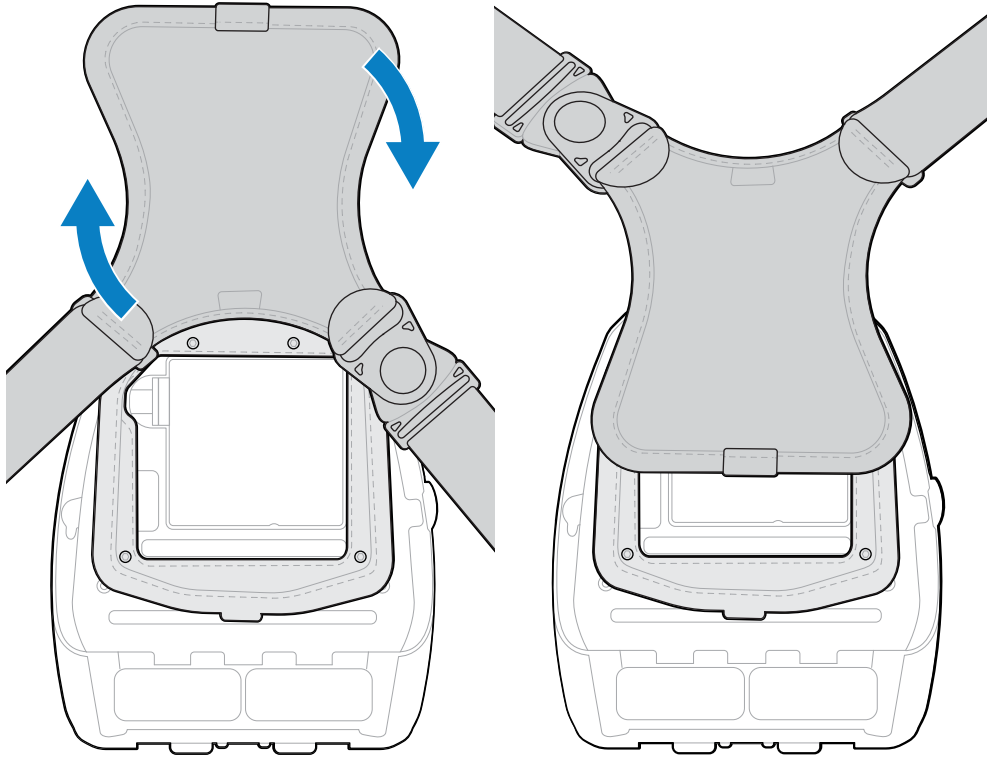

8. Unsnap the waist strap and adjust it to the desired length.
9. Wrap the waist strap around your waist and snap the fastener in place to secure it.
The printer hangs comfortably below the hip.

Configuring the Printer

This section assists you with configuration and adjustments to the printer.

Changing Printer Settings - User Menus





The following section presents the printer settings that you can change and identifies the tools for changing them.

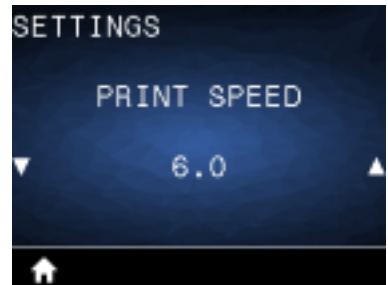



Settings Menu

This section provides details about the printer's Settings menu.

Print Setting	Description	
Darkness	Set the darkness to the lowest setting that provides good print quality. If you set darkness too high, the label image may print unclearly, bar codes may not scan correctly, or the printhead may wear prematurely. SGD: <code>print.tone_zpl</code>	
Print Speed	Select the speed for printing a label (given in inches per second). Slower print speeds typically yield better print quality. SGD: <code>media.speed</code>	

Configuring the Printer

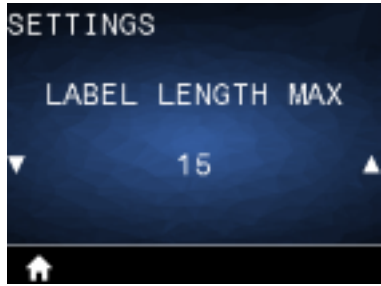
Print Setting	Description	
Media Type	Select the type of media that you are using. SGD: <code>ezpl.media_type</code>	
Tear Off	If necessary, adjust the position of the media over the tear bar after printing. SGD: <code>ezpl.tear_off</code>	
Print Width	Specify the width of the labels being used. The default value is the maximum width for the printer based on the printhead's DPI value. SGD: <code>ezpl.print_width</code>	
Print Mode	Select a print mode that is compatible with your printer options. SGD: <code>ezpl.print_mode</code>	
Label Top	If necessary, shift the position of the image vertically on the label. <ul style="list-style-type: none"> Negative numbers move the image higher on the label (toward the printhead). Positive numbers move the image farther down on the label (away from the printhead) by the specified number of dots. SGD: <code>zpl.label_top</code>	





Print Setting	Description	
Left Position	<p>If necessary, shift the print position horizontally on the label. Positive numbers move the left edge of the image toward the center of the label by the number of dots selected, while negative numbers move the left edge of the image toward the left edge of the label.</p> <p>SGD: <code>zpl.left_position</code></p>	
Reprint Mode	<p>When reprint mode is enabled, you can reprint the last label printed either by issuing certain commands or by pressing the DOWN ARROW on the keypad.</p> <p>SGD: <code>ezpl.reprint_mode</code></p>	
Label Length Max	<p>Set the maximum label length to a value that is at least 25.4 mm (1 in.) greater than the actual label length plus the interlabel gap. If you set the value to one that is smaller than the label length, the printer assumes that continuous media is loaded, and the printer cannot calibrate.</p> <p>SGD: <code>ezpl.label_length_max</code></p>	
Language	<p>If necessary, change the language that the printer displays.</p>	
		<p> NOTE: To facilitate easier selection, the available options for this parameter are displayed in the language you can read.</p>

Tools Menu

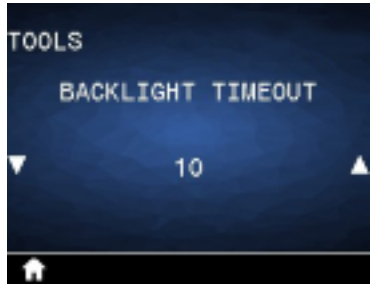
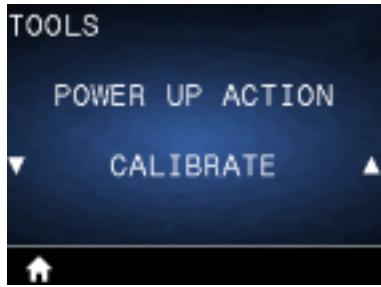
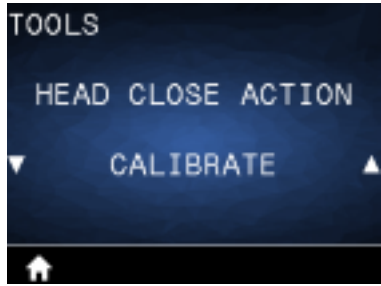
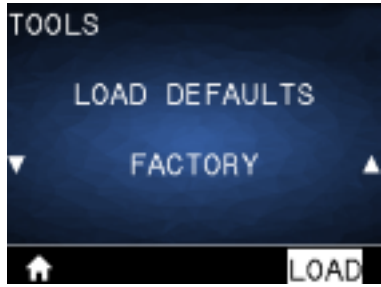
This section provides details about the printer's Tool menu.

Configuring the Printer

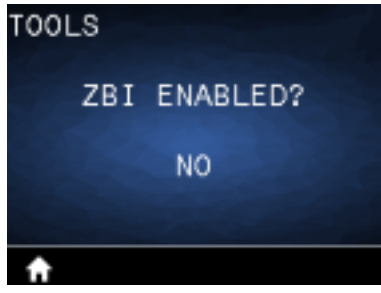



Tools Setting	Description	
Print Information	Prints a printer configuration label, sensor profile, barcode information, font information, images, formats, two-key report, and network settings. SGD: <code>device.user_vars.display_wmlsg_printlist</code>	
Backlight Timeout	Sets the duration of the LCD backlight in seconds. SGD: <code>display.backlight_on_time</code>	
Power Up Action	Set the action for the printer to take during the power-up sequence, for example, no motion, calibrate, etc. SGD: <code>ezpl.power_up_action</code>	
Head Close Action	Set the action for the printer to take when you close the printhead, for example, feed, calibrate, etc. SGD: <code>ezpl.head_close_action</code>	
Load Defaults	Restore specific printer, print server, and network settings back to the factory defaults. Use care when loading defaults because you need to reload all settings that you changed manually. This menu item is available through two user menus with different default values for each. SGD: <code>ezpl.load_defaults</code>	

Tools Setting	Description	
Label Length Cal	Calibrate the printer to adjust the length of the label.	
Diagnostic Mode	Use this diagnostic tool to cause the printer to output the hexadecimal values for all data received by the printer. SGD: <code>device.user_vars.display_diagnostic_list</code>	
ZBI Enabled?	This menu item indicates if the Zebra Basic Interpreter (ZBI 2.0TM.) option is enabled on your printer. If you would like to purchase this option, contact your Zebra reseller for more information. SGD: <code>zbi.key</code>	
Password Protect	Select the level of password protection for user menu items. The default printer password is 1234. SGD: <code>display.password.level</code>	



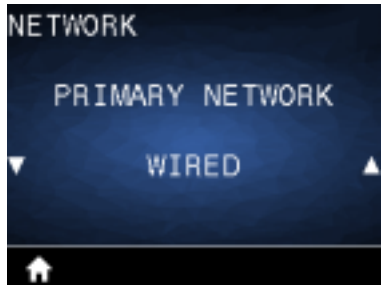

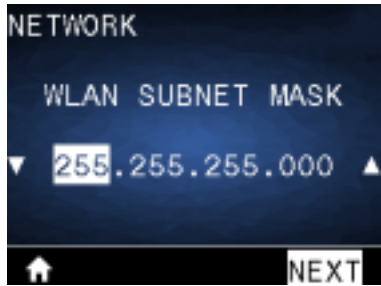
Network Menu

This section provides details about the printer's Network menu.



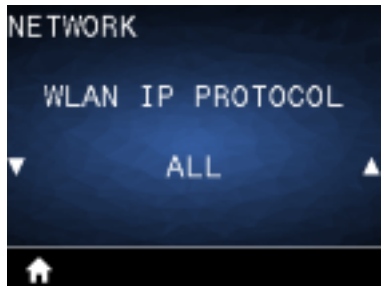

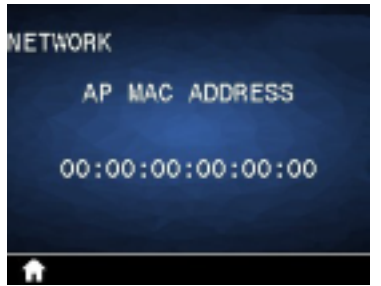
Configuring the Printer

Network Setting	Description	
Active Print Server	<p>Informs you of the presence of an active server. Only one print server can be installed at a time, therefore the print server installed is the active print server.</p> <p>SGD: ip.active_network</p>	
Primary Network	<p>View or modify whether the wireless print server is considered primary. You may select which one is primary.</p> <p>SGD: ip.primary_network</p>	
WLAN IP Address	<p>View, and if necessary, change the printer's WLAN IP address.</p> <p>SGD: wlan.ip.addr</p>	
WLAN Subnet Mask	<p>View, and if necessary, change the WLAN subnet mask.</p> <p>SGD: wlan.ip.netmask</p>	
WLAN Gateway	<p>View, and if necessary, change the default WLAN gateway.</p> <p>SGD: wlan.ip.gateway</p>	



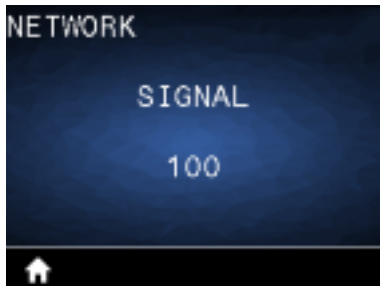

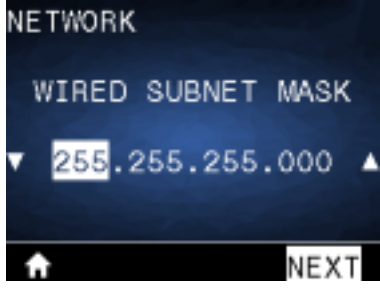
Configuring the Printer

Network Setting	Description	
WLAN IP Protocol	<p>This parameter tells if you (permanent) or the server (dynamic) selects the WLAN IP address.</p> <p>SGD: wlan.ip.protocol</p>	 <p>The screenshot shows a dark blue screen with the word 'NETWORK' at the top. Below it, 'WLAN IP PROTOCOL' is displayed. At the bottom, the value 'ALL' is shown between two small white triangles. A white home icon is visible at the very bottom of the screen.</p>
WLAN MAC Address	<p>View the WLAN Media Access Control (MAC) address of the wireless print server that is installed in the printer.</p> <p>SGD: wlan.mac_addr</p>	 <p>The screenshot shows a dark blue screen with 'NETWORK' at the top. Below it, 'WLAN MAC ADDRESS' is displayed. At the bottom, the MAC address 'AC:3F:A4:89:17:B8' is shown. A white home icon is visible at the very bottom of the screen.</p>
ESSID	<p>The Extended Service Set Identification (ESSID) is an identifier for your wireless network. This setting, which cannot be modified from the control panel, gives the ESSID for the current wireless configuration.</p> <p>SGD: wlan.essid</p>	 <p>The screenshot shows a dark blue screen with 'NETWORK' at the top. Below it, 'ESSID' is displayed. At the bottom, the value '125' is shown. A white home icon is visible at the very bottom of the screen.</p>
AP MAC Address	<p>View the AP MAC address associated with the printer.</p> <p>SGD: wlan.bssid</p>	 <p>The screenshot shows a dark blue screen with 'NETWORK' at the top. Below it, 'AP MAC ADDRESS' is displayed. At the bottom, the MAC address '00:00:00:00:00:00' is shown. A white home icon is visible at the very bottom of the screen.</p>
Channel	<p>View the wireless channel being used when the wireless network is active and authenticated.</p> <p>SGD: wlan.channel</p>	 <p>The screenshot shows a dark blue screen with 'NETWORK' at the top. Below it, 'CHANNEL' is displayed. At the bottom, the value '1' is shown. A white home icon is visible at the very bottom of the screen.</p>

Configuring the Printer

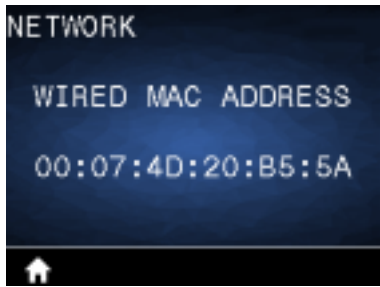
Network Setting	Description	
Signal	View the wireless signal strength when the wireless network is active and authenticated. SGD: wlan.signal_strength	
Wired IP Address	View, and if necessary, change the printer's wired IP address. SGD: internal_wired.ip.addr	
Wired Subnet Mask	View, and if necessary, change the printer's wired subnet mask. SGD: internal_wired.ip.netmask	
Wired Gateway	View, and if necessary, change the wired gateway setting. SGD: internal_wired.ip.gateway	
Wired IP Protocol	This parameter tells if you (permanent) or the server (dynamic) selects the IP address. If a dynamic option is chosen, this parameter tells the method(s) by which the wired or wireless server receives the IP address from the server. SGD: internal_wired.ip.protocol	



Configuring the Printer

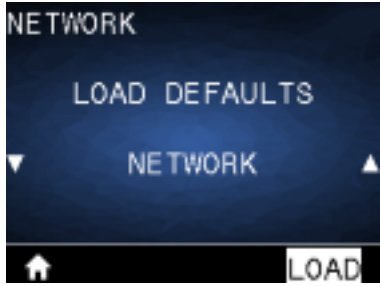



Network Setting	Description	
Wired MAC Address	View, and if necessary, change the printer's network signal. SGD: <code>internal_wired.mac_addr</code>	
IP Port	This printer setting refers to the internal wired print servers port number that the TCP print service is listening on. Normal TCP communications from the host should be directed to this port. SGD: <code>ip.port</code>	
IP Alternate Port	This command sets the port number of the alternate TCP port. SGD: <code>ip.port_alterate</code>	
Print Information	Print the specified information on one or more labels. This menu item is available through three user menus with different default values for each. SGD: <code>device.user_vars.display_wmlsgd_printlist</code>	
Reset Network	This option resets the wired or wireless print server and saves any changes that you made to any network settings.	



Network Setting	Description	
Visibility Agent	<p>When the printer is connected to a wired or wireless network, it attempts to connect to Zebra's Asset Visibility Service via the Cloud-based Zebra Printer Connector using an encrypted, certificate-authenticated web socket connection. The printer sends Discovery Data and Settings and Alerts Data. Data printed via any label format is NOT transmitted. To opt out of this feature, disable this setting.</p> <p>SGD: <code>weblink.zebra_connector.enable</code></p>	
Load Defaults	<p>Restore specific printer, print server, and network settings back to the factory defaults. Use care when loading defaults because you need to reload all settings that you changed manually. This menu item is available through two user menus with different default values for each.</p> <p>SGD: <code>ezpl.load_defaults</code></p>	

RFID Menu

This section provides details about the printer's RFID menu.

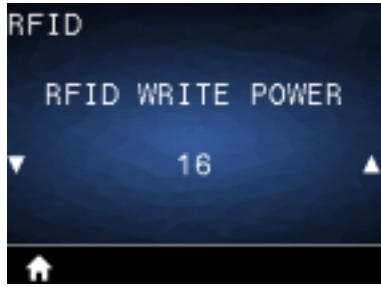

RFID Setting	Description	
RFID Status	<p>Display the status of the RFID subsystem of the printer.</p> <p>SGD: <code>rfid.error.response</code></p>	
RFID Calibrate	<p>Initiate tag calibration for RFID media. (Not the same as media calibration.) During the process, the printer moves the media, calibrates the RFID tag position, and determines the optimal settings for the RFID media being used.</p> <p>SGD: <code>rfid.tag.calibrate</code></p>	



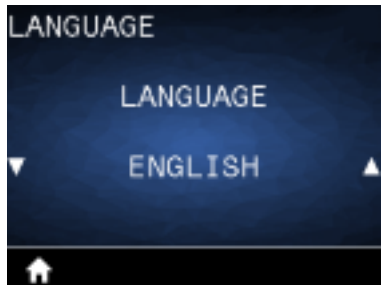

RFID Setting	Description	
Read RFID Data	Read and return the specified tag data from the RFID tag. SGD: <code>rfid.tag.read.content</code> & <code>rfid.tag.read.execute</code>	
RFID Test	During the RFID test, the printer attempts to read and write to a transponder. SGD: <code>rfid.tag.test</code> & <code>rfid.tag.test.execute</code>	
RFID Programming Position	If the desired programming position (read/write position) is not achieved through RFID tag calibration, a value may be specified. SGD: <code>rfid.position.program</code>	
RFID Read Power	If the desired read power is not achieved through RFID tag calibration, a value may be specified. SGD: <code>rfid.reader_1.power.read</code>	
RFID Write Power	If the desired write power is not achieved through RFID tag calibration, a value may be specified. SGD: <code>rfid.reader_1.power.write</code>	

RFID Setting	Description	
RFID Valid Count	Resets the RFID valid label counter to zero. SGD: <code>odometer.rfid.valid_ resettable</code>	
RFID Void Count	Resets the RFID void label counter to zero. SGD: <code>odometer.rfid.void_ resettable</code>	

Language Menu

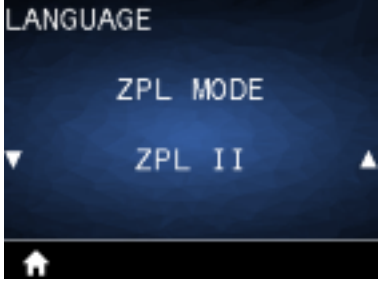

This section provides information about the printer's Language menu.

Language Setting		
Language	If necessary, change the language that the printer displays. SGD: <code>display.language</code>	
	 NOTE: The available options for this parameter are displayed in the language you are able to read.	
Command Language	View or select the appropriate command language. SGD: <code>device.languages</code>	

Language Setting		
<p>Command Char</p>	<p>The format command prefix is a two-digit hex value used as a parameter place marker in ZPL/ZPL II format instructions. The printer looks for this hex character to indicate the start of a ZPL/ZPL II format instruction. Set the format command character to match what is used in your label formats.</p> <p>SGD: <code>zpl.format_prefix</code></p>	
<p>Control Char</p>	<p>Set the control prefix character to match what is used in your label formats.</p> <p>SGD: <code>zpl.command_prefix</code></p>	
<p>Delimiter Char</p>	<p>The delimiter character is a two-digit hex value used as a parameter place marker in ZPL/ZPL II format instructions. Set the delimiter character to match what is used in your label formats.</p> <p>SGD: <code>zpl.delimiter</code></p>	
<p>ZPL Mode</p>	<p>Select the mode that matches what is used in your label formats. This printer accepts label formats written in either ZPL or ZPL II, eliminating the need to rewrite any ZPL formats that already exist. The printer remains in the selected mode until it is changed in one of the ways listed here.</p> <p>SGD: <code>zpl.zpl_mode</code></p>	
<p>Virtual Device</p>	<p>If any Virtual Device apps are installed on your printer, you may view or enable/ disable them from this user menu. For more information about Virtual Devices, go to the User Guide for the appropriate Virtual Device, or contact your local reseller.</p> <p>SGD: <code>apl.selector</code></p>	

Sensors Menu

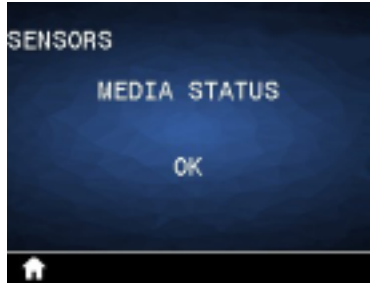

This section provides information about the printer's Sensors menu.

Sensors Setting	Description	
Media Status	<p>Informs you of the presence or absence of media in the printer.</p> <p>SGD: <code>media.status</code></p>	
Take Label	<p>Set the intensity of the take label LED.</p> <p>SGD: <code>ezpl.take_label</code></p>	
	<p> NOTE: This value is set during sensor calibration. Do not change this setting unless you are told to do so by Zebra Technical Support or by an authorized service technician.</p>	

Communications Menu



This section provides information about the printer's Communications menu.

Sensors Setting	Description	
Halt on Error	<p>Informs you of the presence or absence of media in the printer.</p>	

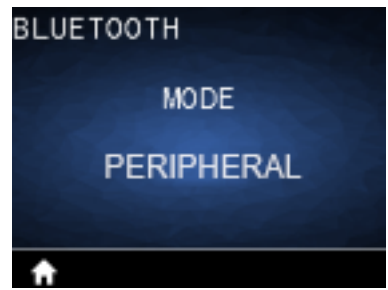

Sensors Setting	Description	
MFI Capability	This option detects whether the device is compatible with of Apple "Made for iPhone/iPad/iPod" devices.	
	 NOTE: This value is set during sensor calibration. Do not change this setting unless you are told to do so by Zebra Technical Support or by an authorized service technician.	

Bluetooth Menu

This section provides information about the printer's Bluetooth menu.

Bluetooth Setting	Description	
Bluetooth Address	View the Bluetooth address for the presence of a BT radio. SGD: bluetooth.address	
Mode	View the Bluetooth connection pair printer's device type—PERIPHERAL always displays.	
Discovery	Select if the printer is "Discoverable" for Bluetooth device pairing. View the discovery status, for example, ON or OFF. SGD: bluetooth.discoverable	

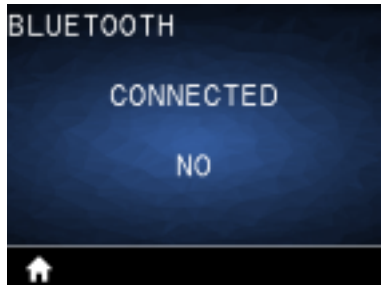

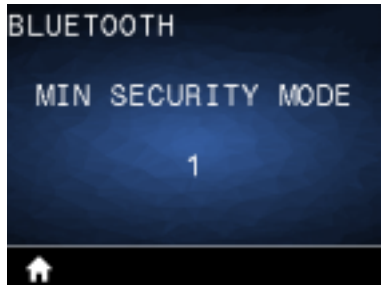

Configuring the Printer

Bluetooth Setting	Description	
Connected	View the connection status of the BT radio, for example, YES or NO. SGD: <code>bluetooth.connected</code>	
BT Spec Version	View the Bluetooth operational specification level. SGD: <code>bluetooth.radio_version</code>	
Minimum Security Mode	View, and change if necessary, the minimum level of applied security of the BT radio. SGD: <code>bluetooth.minimum_security_mode</code>	

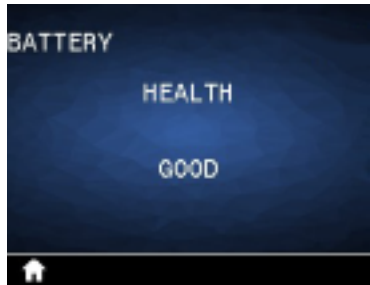

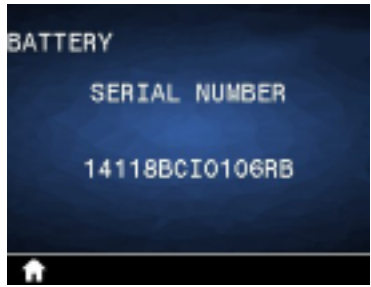

Battery Menu

This section provides details about the printer's Battery menu.

Battery Setting	Description	
Health	Indicates the current health of the battery, for example, Good, Past Useful Life, etc. SGD: <code>power.health</code>	

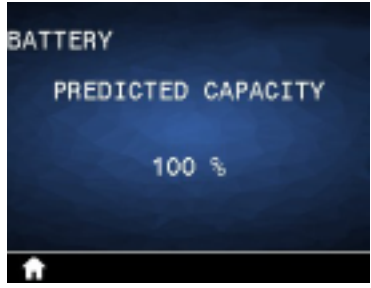
Battery Setting	Description	
Cycle Count	View the current charging cycle count of the battery. SGD: <code>power.cycle_count</code>	
Serial Number	Indicates the serial number of the battery pack. SGD: <code>power.serial_number_string</code>	
Timeout (Seconds)	View, and if necessary, change the battery timeout. SGD: <code>power.inactivity_timeout_ alt</code>	
Voltage	View the current voltage level of the battery pack. SGD: <code>power.voltage</code>	
Warning	SGD: <code>power.low_battery_warning</code>	

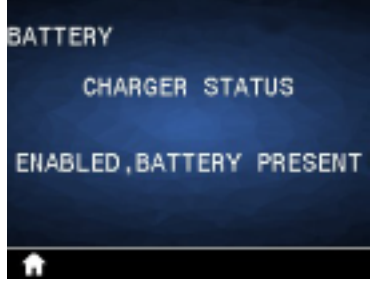
Configuring the Printer

Battery Setting	Description	
DTR Control	SGD: <code>power.dtr_power_off</code>	
Predicted Capacity	SGD: <code>power.relative_state_of_ charge</code>	
Battery Capacity	Battery capacity measured in MAH. SGD: <code>power.remaining_capacity</code>	
Charger Status	Indicates the presence of a battery charger. SGD: <code>power.chrgr_status</code>	
Battery Health	SGD: <code>power.percent_health</code>	

RFID Calibration

RFID calibration sets communication parameters for your tag type. This procedure must be done after the printer is calibrated for the media (length and gap settings), typically a label length calibration. During the RFID calibration process, the printer moves the media, calibrates the RFID tag position, and determines the optimal settings for the RFID media being used.

These settings include the programming position and the read/write power level to use. To restore the printer's default programming position at any time, use the Restore option in the `rfid.tag.calibrate` SGD command.

Do not remove any labels or tags from the liner (label backing or 'web'). This allows the printer to determine RFID settings that do not encode adjacent tags.

Always a Label Length Calibration and RFID Calibration when you change media type. However, this step is unnecessary when replacing an empty roll of the same media.

RFID Calibration Process

Before calibrating, load RFID media into the printer and perform the label length calibration.

1. Press **FEED** once to advance one label.
2. Select Home using **LEFT SELECT**. Navigate to the RFID menu and press **OK**.
3. Use **LEFT ARROW** and **RIGHT ARROW** to select the RFID CALIBRATE procedure, and then press **OK**.

The printer slowly feeds a label while adjusting the location and RFID read/write communication settings for your chosen RFID tag/label. In some cases, the printer feeds an additional label when calibration has been completed successfully with the display message reading: READY.

4. Remove the excess media.

Media calibration finishes and you are ready to print.

Using the Printer

This section describes utilizing the printer effectively, from creating labels to pairing the printer to a personal device.

Creating Labels

Zebra offers multiple methods for label creation, including utilizing specialized software, employing the appropriate programming commands, and providing guidance on label design considerations. These approaches will help you efficiently generate labels that meet your requirements while ensuring compatibility with Zebra's resources and standards.

Using Label Design Content

Select and install the software that you will use to create label formats for your printer.

One option is ZebraDesigner, which you can download from zebra.com/zebradesigner. You can choose to use ZebraDesigner Essentials for free or purchase ZebraDesigner Professional for a more robust toolset.

Figure 22 Sample ZebraDesigner Essentials Screen

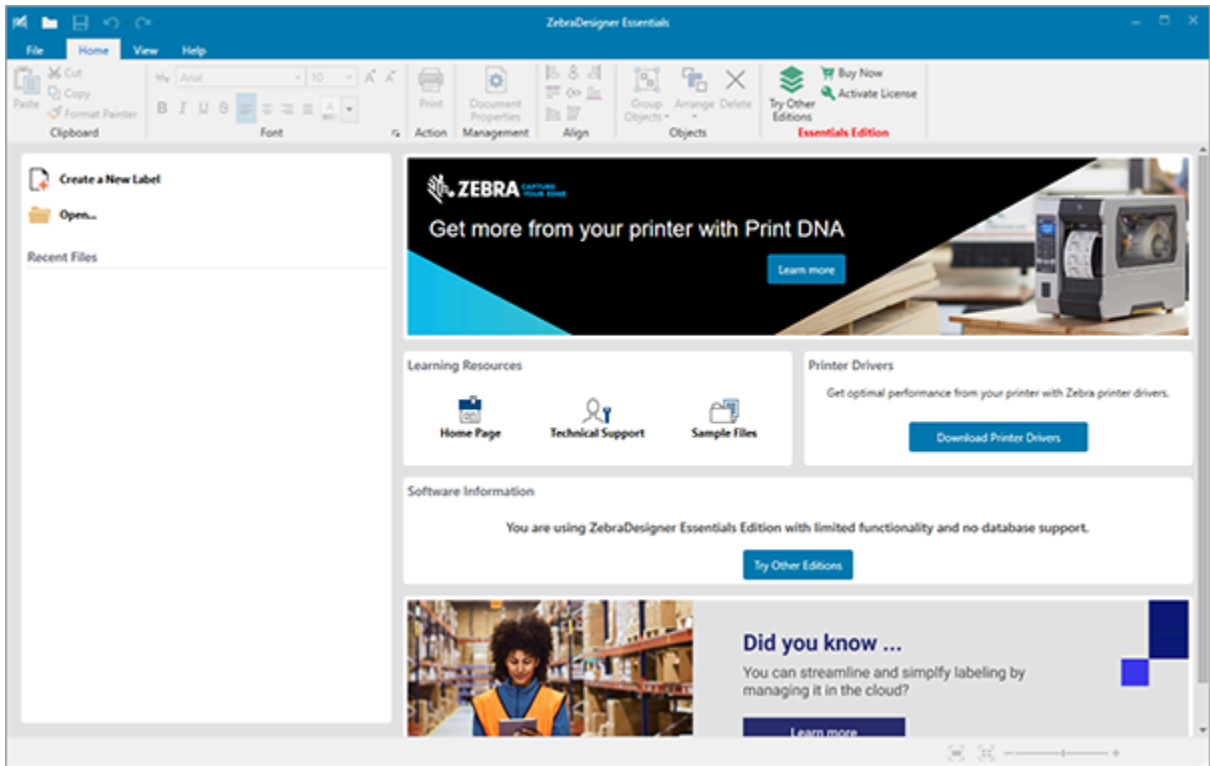

Using ZPL/CPCL/EPL Commands

The ZQ600 Plus series printers use Zebra's CPCL, ZPL, or EPL Programming languages designed for mobile printing applications. CPCL and ZPL are fully described in:

- ZPL & CPCL Printer Driver for OPOS Application Programmer's Guide.
- ZPL II, ZBI 2, Set-Get-Do Mirror, WML Programming Guide (Zebra Programming Guide).

Label Design Considerations

The following examples provide guidelines for designing labels for the printers, specifically for Gap Media, Black Bar Media, and Journal Media. The illustrations for each media type define recommended tolerances, keep-out zones, and safe printing zones designed to avoid any vertical registration issues during printing. Dimensions are determined based on product registration capabilities and Zebra-recommended media tolerances.

Figure 23 Gap Media

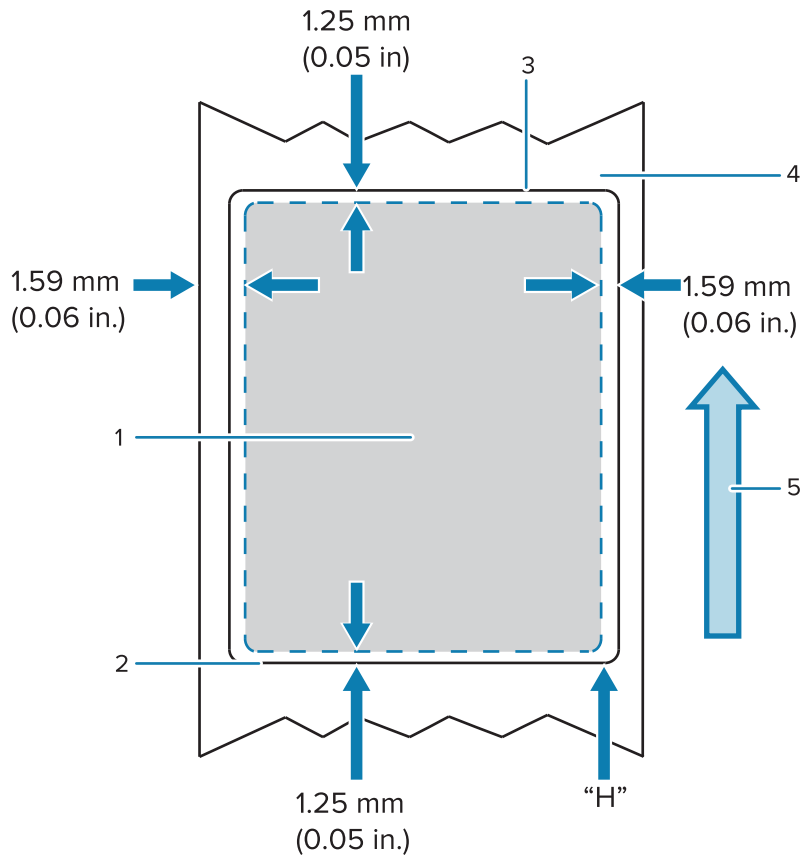

1	Safe Printing Zone
2	Bottom Edge of Die-Cut Label
3	Top Edge of Die-Cut Label
4	CPCL Label Height
5	Media Feed Direction



NOTE: Maximum Label Height = "H" = 2.5 mm (0.10 in.)

Figure 24 Journal Media

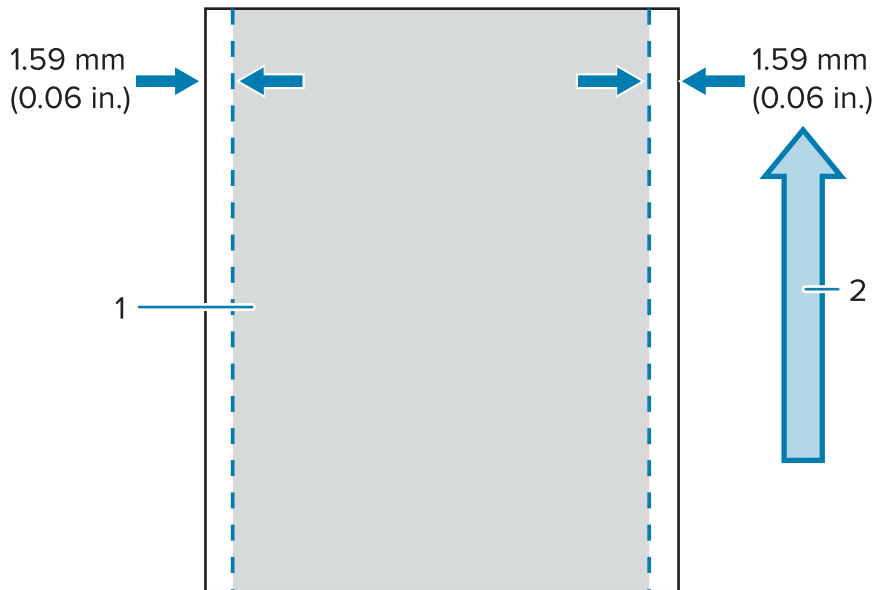

1	Safe Printing Zone
2	Media Feed Direction

Figure 25 Black Bar Media

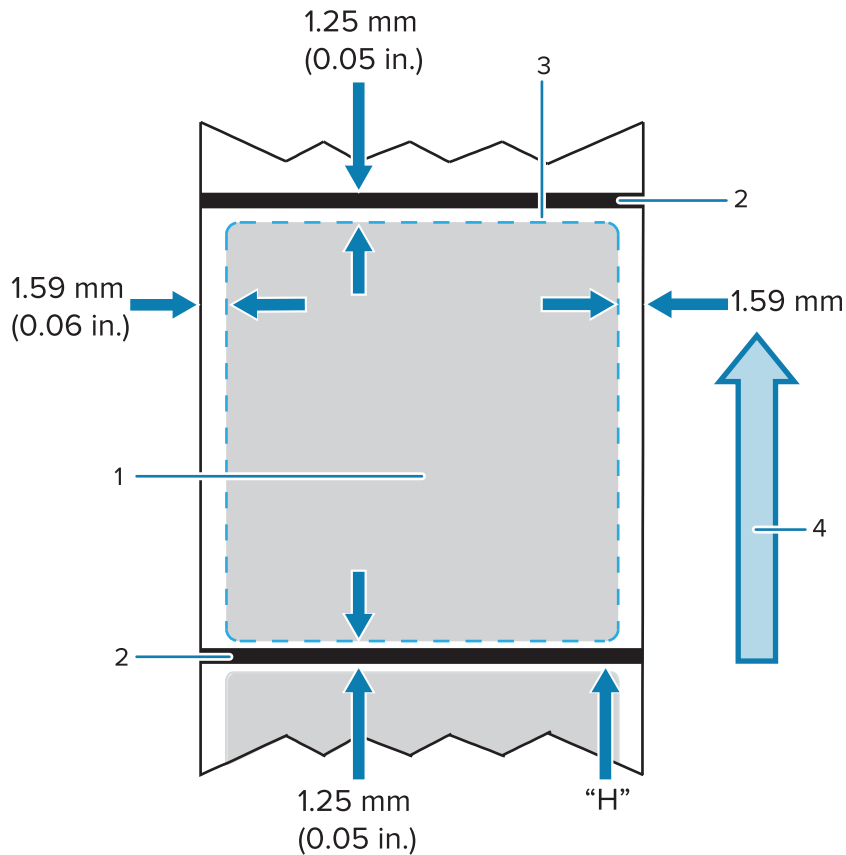

1	Safe Printing Zone
2	Black Bars
3	CPCL Label Height
4	Media Feed Direction



NOTE: Maximum Label Height = "H" = 2.5 mm (0.10 in)

Using Pre-Printed Receipt Media

ZQ600 Plus series printers support the alignment of pre-printed receipts by using the out-of-paper sensor located near the printhead.

Black Mark Dimensions (Receipt Media)

The reflective media black marks (or black bar/marks) should extend past the centerline of the roll on the front side of the paper.

- Minimum mark width: 15 mm (0.59 in.) perpendicular to the edge of the media, and centered within the width of the roll.
- Mark length: 4.8–6.0 mm (0.19–0.24 in.) parallel to the edge of the media.

Label Areas

The media/black bar sensor detects the dark, pre-printed bar on the media, so a path in the center of the paper must be kept free of dark, pre-printed graphics.



NOTE: Dark, pre-printed graphics refer to any symbols, barcodes, text and/or colored areas that have been applied to the receipt paper rolls before they have ever been used in the printer.

Figure 26 Label Areas

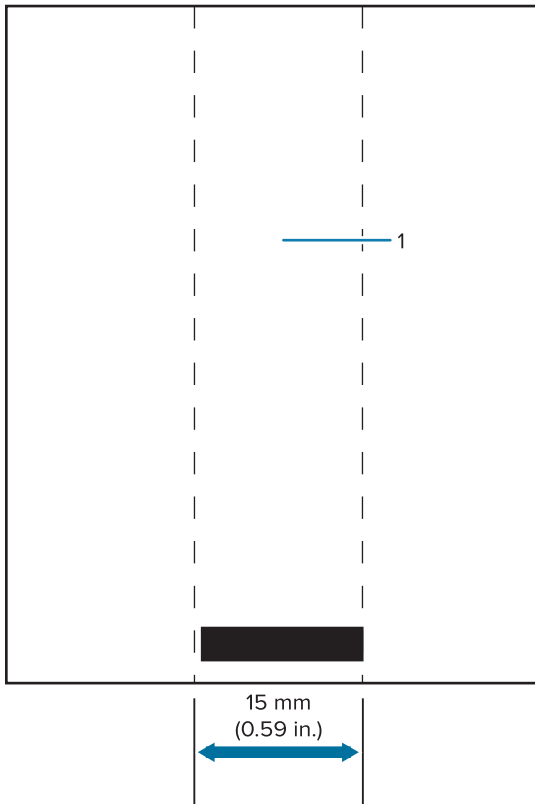

1	Center Label Area Path
---	------------------------





NOTE:

Keep dark color pre-printed graphics, barcodes, and text out of the path of the sensor.

Label Design Examples

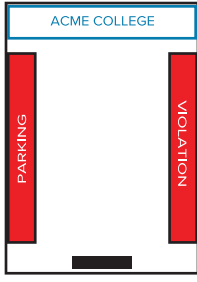
This section shows examples of labels with and without problems.

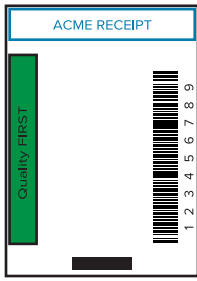
Problem Label Designs	Good Label Designs
	
<p>The dark colors, pre-printed text, and graphics are in the path of the black bar at the bottom of the receipt.</p>	<p>The center path to the black bar is free of dark colors, pre-printed text, and graphics.</p>
	



NOTE: Complete information on using pre-printed receipt paper can be found in the FORM command in the CPCL Programming Guide at zebra.com/manuals.

Keep-Out Areas

At times, incomplete printing of text and/or graphics appear because minimum margins are not provided during label design. The recommended minimum margins, or keep-out areas are shown below.

Figure 27 Keep-Out Areas

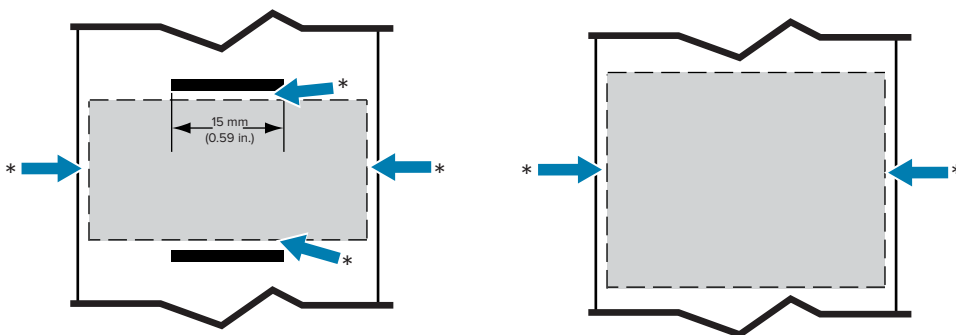

NOTE: The length of each continuous receipt is determined by the data sent to the printer.

Wireless Communications with Bluetooth

Bluetooth is a worldwide standard for the exchange of data between two devices via radio frequencies. This form of point-to-point communication does not require access points or other infrastructure. Bluetooth

radios are relatively low powered to help prevent interference with other devices running at similar radio frequencies. This limits the range of a Bluetooth device to about 10 meters (32 feet). The default for the ZQ630 Plus is Class 2, but the range can be set to Class 1 via a SGD (`bluetooth.power_class`) to increase power. Both the printer and the device it communicates with must follow the Bluetooth standard.

Bluetooth Networking Overview

Each Bluetooth-enabled ZQ600 Plus series printer is identified by a unique Bluetooth Device Address (BDADDR). This address resembles a MAC address whereby the first three bytes are vendor, and the last three bytes are device (for example, 00:22:58:3C:B8:CB). This address is labeled on the back of the printer via a barcode for ease of pairing. (For the dual radio, the MAC address label only represents WiFi MAC address (go to [Basic Drawing and Information about Parts](#) on page 9)). To exchange data, two Bluetooth-enabled devices must establish a connection. Bluetooth software is always running in the background, ready to respond to connection requests. One device (known as the client) must request/initiate a connection with another. The second device (the server) then accepts or rejects the connection. A Bluetooth-enabled ZQ600 Plus series printer normally acts as a peripheral, creating a miniature network with the host sometimes referred to as a “piconet”. Discovery identifies Bluetooth devices that are available for pairing whereby the controller device broadcasts a discovery request and devices respond. If a device is not discoverable, the controller cannot pair unless it knows the BDADDR or has previously paired with the device. If both devices support Bluetooth 2.1 or higher, they use Security Level 4 Secure Simple Pairing (SSP), a mandatory security architecture that features two association models: Numeric Comparison and Just Works (no user confirmation).

Bluetooth Security Modes

<p>Security Mode 1</p> <p>If a BT \geq 2.1 device is pairing with a BT \leq 2.0 device, it falls back to BT 2.0 compatibility mode and behaves the same as BT 2.0. If both devices are BT \geq 2.1, Secure Simple Pairing must be used according to the BT spec.</p>
<p>Security Mode 2</p> <p>If a BT \geq 2.1 device is pairing with a BT \leq 2.0 device, it falls back to BT 2.0 compatibility mode and behaves the same as BT 2.0. If both devices are BT \geq 2.1, Secure Simple Pairing must be used according to the BT spec.</p>
<p>Security Mode 3</p> <p>If a BT \geq 2.1 device is pairing with a BT \leq 2.0 device, it falls back to BT 2.0 compatibility mode and behaves the same as BT 2.0. If both devices are BT \geq 2.1, Secure Simple Pairing must be used according to the BT spec.</p>
<p>Security Pairing 4: Simple Secure Pairing</p> <p>Simple Secure Pairing: a new security architecture introduced supported in BT \geq 2.1. Service-level enforced, similar to mode 2. Mandatory when both devices are BT \geq 2.1. There are four association models currently supported by mode 4. Security requirements for services must be classified as one of the following: authenticated link key required, unauthenticated link key required, or no security required. SSP improves security through the addition of ECDH public key cryptography for protection against passive eavesdropping and man-in-the-middle (MITM) attacks during pairing.</p>

Numeric Comparison	Just Works
Designed for situation where both devices are capable of displaying a six-digit number and allowing user to enter “yes” or “no” response. During pairing, user enters “yes” if number displayed on both devices matches to complete pairing. Differs from the use of PINs in legacy (BT<=2.0) pairing because the number displayed for comparison is not used for subsequent link key generation, so even if it is viewed or captured by an attacker, it could not be used to determine the resulting link or encryption key.	Designed for situation where one (or both) of the pairing devices has neither a display nor keyboard for entering digits (for example, Bluetooth headset). It performs authentication step 1 in the same manner as as numeric comparison, but you cannot verify that both values match, so MITM (man-in-the-middle) protection is not provided. This is the only model in SSP that does not provide authenticated link keys.

Each mode, except for Just Works, has Man-In-The-Middle (MITM) protection, meaning no third device can view the data being passed between the two devices involved. The SSP mode is usually negotiated automatically based on the capabilities of both the controller and follower. Lower security modes can be disabled via the `bluetooth.minimum_security_mode`. The `bluetooth.minimum_security_mode` SGD sets the lowest security level at which the printer establishes a Bluetooth connection. The printer always connects at a higher security level if requested by the controller device. To change the security mode and security settings in the ZQ630 Plus printer, use Zebra Setup Utilities.

Bluetooth Minimum Security Modes

Security Mode	Bluetooth Version of Controller Devices (>2.1)
<code>bluetooth.minimum_security_mode=1</code>	Secure Simple Pairing
<code>bluetooth.minimum_security_mode=2</code>	Just Works/Numeric Comparison
<code>bluetooth.minimum_security_mode=3</code>	
<code>bluetooth.minimum_security_mode=4</code>	
<code>bluetooth.bluetooth_PIN</code>	Not used



IMPORTANT: The `bluetooth.minimum_security_mode` SGD sets the lowest security level at which the printer establishes a Bluetooth connection. The printer always connects at a higher security level if requested by the controller device.

The ZQ600 Plus Series printers also feature bonding for Bluetooth. The printer caches pairing info so devices stay paired through power cycles and disconnects. This eliminates the need to re-pair on every connection establishment.

The `bluetooth.bonding` SGD is on by default.

WLAN Overview

The ZQ600 Plus Series has dual radios that use industry-standard Wi-Fi and Bluetooth protocols. Zebra offers you a choice between a device equipped with Wi-Fi 6 dual radio (802.11ax + Bluetooth 5.3) or Wi-Fi 5 dual radio (802.11ac + Bluetooth 4.2). They have the FCC ID number on the serial number label on the back of the unit.

- The ZQ600 Plus Series Wireless Network Printers with the Zebra 802.11 WLAN radio module are identified by the Wireless Network Printer text on the serial number label on the back of the printer.

- These printers allow communication as a node within a wireless local area network (WLAN). Methods of establishing communications with the printer vary with each application.

More information and LAN configuration utilities are included in the ZebraNet Bridge Enterprise™ program (version 2.8 and later).

Zebra Setup Utilities (ZSU) and Zebra Mobile Setup Utility are used to configure WLAN communications settings. Both ZebraNet Bridge Enterprise and ZSU may be downloaded from the Zebra website.

Figure 28 BT/WLAN Communications

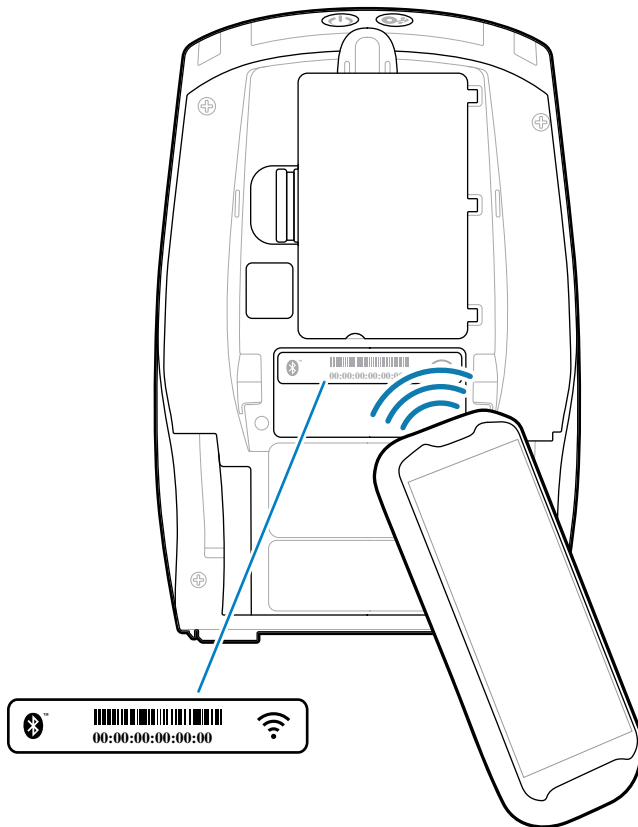

Print Touch/NFC

The ZQ600 Plus Series printers support Print Touch - also known as Near Field Communication (NFC), which is a passive NFC tag that complies with the Android Standard Tag format. The NFC tag is programmed from the factory and supports Bluetooth pairing to enable a tablet, smartphone, or mobile computer to automatically pair with the printer via a Bluetooth connection (within the bounds of the security profile being used).

Figure 29 Near Field Communication (NFC) Pairing

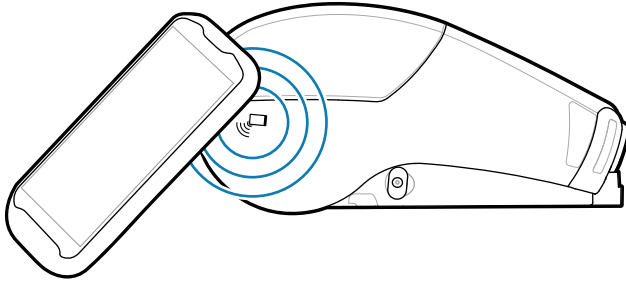

The NFC tag also supports app launching, where an app developed either by Zebra or a third party launches on an NFC-enabled smartphone, tablet, or mobile computer. Similarly, the NFC tag enables launching to a web support page via a tablet, smartphone, or mobile computer.

Devices using NFC are active or passive. A passive device contains information that other devices can read, but the NFC tag does not read any information itself. An active device, such as a smartphone, can read the information on the printer's NFC tag, but the tag itself only transmits data to authorized devices.

NFC Use Cases

Below are a few instances demonstrating passive NFC technology.

- Bluetooth Pairing – causes a tablet, smart phone or mobile computer to automatically pair with the printer via a Bluetooth connection within the bounds of the security profile being used. The profile contains the BT address and serial number of the printer.
- App launching – causes an app, developed either by Zebra or a third party, to be executed on a smart phone, tablet or mobile computer.
- Web site launching – causes a smart phone, tablet or mobile computer to display a web site developed by Zebra or a third party developer



NOTE: Tapping the Zebra Print Touch icon with an NFC enabled smartphone provides instant access to printer-specific information. For more information about NFC and Zebra products, go to zebra.com/nfc. Pairing Bluetooth applications by NFC is also possible. Go to zebra.com/sdk for more information.

Radio Frequency Identification (RFID)



NOTE: RFID is an optional feature on the ZQ630 Plus and is a factory-installed option only.

The ZQ630 Plus printer is equipped with an RFID encoder/reader that is integrated into the printer's printhead assembly. The ZQ630 Plus encodes (writes) information on ultra-thin UHF RFID transponders that are embedded in "smart" labels, tickets, and tags. The printer encodes the information, verifies proper encoding, and prints bar codes, graphics, and/or text on the label's surface. The ZQ630 Plus printer uses Zebra's extensive set of RFID commands running under ZPL programming language.

The RFID transponder is sometimes called the RFID tag or an inlay. The transponder is usually made of an antenna that is bonded to an integrated circuit (IC) chip. The IC chip contains the RF circuit, coders, decoders, and memory. If you hold an RFID label up to the light, you can see the transponder's antenna, and you can feel a bump in the label where the IC chip is located. The ZQ630 Plus can encode and verify EPC (Electronic Product Code) Generation 2 Class 1 UHF passive RFID tags, in addition to printing human readable text and conventional 1- and 2-D barcode information on Zebra supplied RFID thermal transfer

media. EPC is a product numbering standard that can be used to identify a variety of items by using RFID technology. EPC Generation 2 tags offer advantages over other tag types. The tag identification (TID) memory in a Generation 2 tag includes the chip manufacturer and model number information, which can be used to identify which optional features are present on the tag. These optional features include those for data content and security.

Gen 2 tags typically have a 96-bit EPC identifier, which is different from the 64-bit identifiers common in early EPC tags. The 96-bit EPC code links to an online database, providing a secure way of sharing product-specific information along the supply chain. Gen 2 tags also support much larger data structures. The size of user memory available (if any) varies by the model and manufacturer of the tag.

Encoding and printing of an RFID label usually are completed on the first try, but some failures may occur. If you experience consistent encoding failures, it may signal a problem with the RFID tags, your label formats, or with the transponder placement. If an RFID tag cannot be encoded, VOID is printed on the label. The printer then attempts to read/encode “n” labels before the next format is attempted, where “n” is specified by the ZPL programming language `^RS` command. Acceptable values of “n” are 1–10 and the default is 3. After printing the defined number of voided RFID labels, the printer default is No Action (Label format causing the error is dropped).

While you do not have control of where on the label the VOID is printed, you can control the length of the image. The start of the VOID image is always at the program position (or F0 if a backward program position). More information on the `^RS` command may be found in the RFID Programming Guide 3 available on zebra.com.

Maintaining the Printer

This section provides routine cleaning and maintenance procedures.

Recommended Cleaning Schedule

Routine preventive maintenance is a crucial part of normal printer operation. By taking good care of your printer, you can minimize the potential problems that you might have with it and help to achieve and to maintain your standards for print quality.

Specific cleaning procedures are provided on the following pages. This table shows the recommended cleaning schedule. These intervals are intended as guidelines only. You may have to clean more often, depending on your application and media.



NOTE:

- Avoid possible personal injury or damage to the printer.
- Never insert any pointed or sharp objects into the printer.
- Always turn off the printer before performing any cleaning procedures.
- Use care when working near the tear bars, as the edges are very sharp.



WARNING: The printhead can get very hot after prolonged printing. Allow it to cool off before attempting any cleaning procedures.



IMPORTANT: Only use a Zebra cleaning pen (not supplied with the printer) or a cotton swab with 90% medical-grade alcohol for cleaning the printhead.



CAUTION: Use only cleaning agents specified in the following tables. Zebra is not responsible for damage caused by the use of cleaning fluids on this printer.

Area	Method	Interval
Printhead	Use a Zebra cleaning pen to swab the thin gray line on the printhead, cleaning the print elements from the center to the outside edges of the printhead.	After every five rolls of media (or more often, if needed). When using linerless type media, cleaning is required after every roll of media.
Platen Surface (Linered)	Rotate the platen roller and clean it thoroughly with a fiber-free swab or lint-free, clean, damp cloth lightly moistened	After every five rolls of media (or more often, if needed)

Area	Method	Interval
	with medical-grade alcohol (90% pure or better).	
Platen Surface (Linerless)	Rotate the platen roller and clean with a fiber-free swab and 1 part liquid soap and 25 parts water. Use pure water to clean after soap/water mixture.	Clean the platen only if there is an issue during printing; for example, the media does not release from the platen (see the note below the table).
Scraper (Linerless Units Only)	Use the adhesive side of the media to clean the scraper on linerless units.	After every five rolls of media (or more often, if needed).
Tear Bar	Clean thoroughly with 90% medical-grade alcohol and a cotton swab.	As needed
Printer Exterior	Water-dampened cloth or 90% medical-grade alcohol wipe.	As needed
Printer Interior	Gently brush out the printer. Ensure the Bar Sensor and Gap Sensor windows are free of dust.	As needed
Interior of units with Linerless Platens	Clean thoroughly with 90% medical-grade alcohol and a fiber-free swab.	After every five rolls of media (or more often, if needed).



NOTE: This is an emergency procedure only to remove foreign contaminants (oils, dirt) from the platen that can damage the printhead or other printer components. This procedure will shorten or even exhaust the linerless platen's useable life. If the linerless media continues to jam after cleaning and feeding 1–2 m (3–5 ft.) of media, replace the platen.

Cleaning the Linerless Printer (ZQ610 Plus/ZQ620 Plus)

Figure 30 Cleaning the Linerless Printer (ZQ610 Plus/ZQ620 Plus)

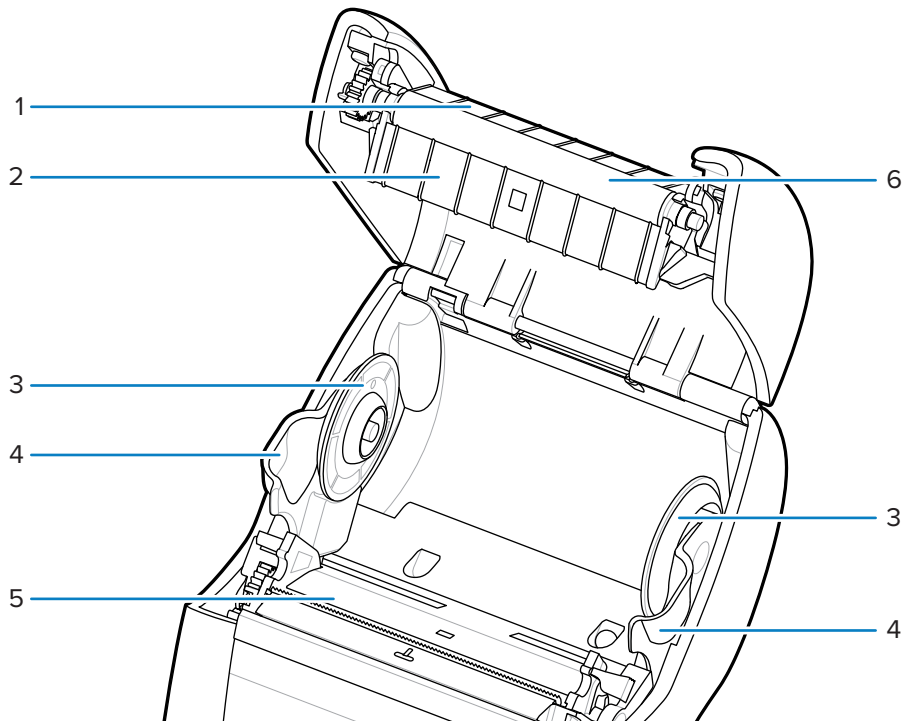

1	Scraper
2	Platen Holder
3	Media Support Disks
4	Media Support
5	Printhead Elements
6	Platen Roller

Cleaning the Linerless Printer (ZQ630 Plus)

Figure 31 Cleaning the Linerless Printer (ZQ630 Plus)

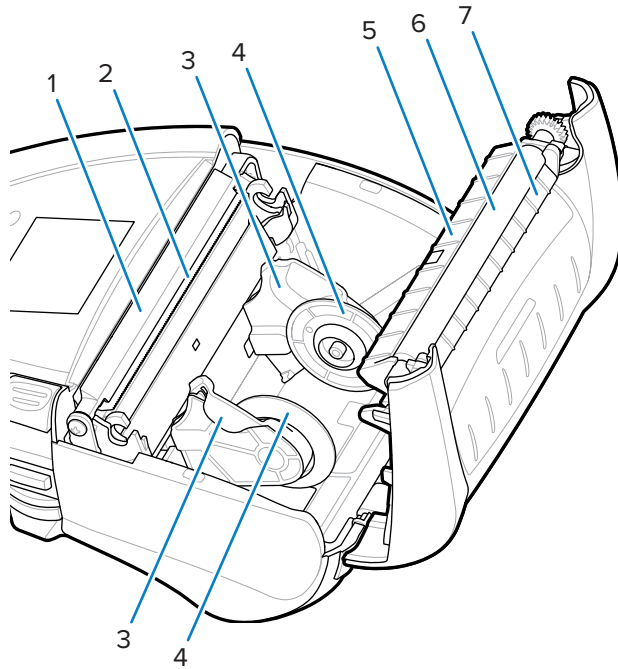

1	Peeler Bail
2	Printhead Elements
3	Media Supports
4	Media Support Disks
5	Platen Holder
6	Platen Roller
7	Scraper

Troubleshooting

This section provides diagnostic tests and other information that may help you to optimize printing or to troubleshoot issues with your printer.

Go to zebra.com/zq600plus-info for access to videos and additional online information designed to assist you.

Contacting Technical Support

If you have a problem using the printer, contact your facility's technical or systems support. If there is a problem with the printer, they will contact the Zebra Global Customer Support Center at zebra.com/support.

Gather the following information before contacting Zebra Global Customer Support:

- Serial number of the unit
- Model number or product name
- Product Configuration Code (PCC) (15-digit number found on the label on the back of the unit and in the configuration label)

Zebra responds to calls by e-mail, telephone, or fax within the time limits set forth in service agreements. If your problem cannot be solved by Zebra Global Customer Support, you may need to return your equipment for servicing and will be given specific directions.

If you purchased your product from a Zebra business partner, please contact that business partner for support.

Error Indicators

Mobile printer error indicators are designed to alert you to any issues or malfunctions that may arise during printing. The indicators provide visual cues such as flashing lights or specific color patterns to indicate the nature of the error, helping you to diagnose and resolve the problem.

Error Messages

The ZQ600 Plus series printers displays various blinking alerts, such as Media Out, Media Cover Open, or Battery Low. These alerts are broken up into Errors, Warnings, and Info with different color mapping used to differentiate one from the other.

Display Item	INFO	WARNING	ERROR
Foreground Color (Text)	White	Black	White
Background Color	Green	Yellow	Red

You can respond to actions by pressing **LEFT SELECT** or **RIGHT SELECT** . When the problem is resolved, the alert message clears.

Alert Messages

Message	Type	Color
AckAlertOptionBoardInvalid	Warning	Yellow
AckAlertYN1	Info	Green
AckAlertNoUsbDriveFound	Warning	Yellow
AckAlertAllFilesPrinted	Info	Green
AckAlertAllFilesStored	Info	Green
AckAlertTooManyUsbHostDevices	Warning	Yellow
AckAlertUnsupportedUsbHostDevice	Warning	Yellow
AckAlertUnsupportedUsbHostFilesystem	Warning	Yellow
AckAlertErrorPrintingFile	Error	Red
AckAlertErrorStoringFile	Error	Red
AckAlertErrorPrintingFileContinue	Error	Red
AckAlertErrorStoringFileContinue	Error	Red
AckAlertFirmwareFoundContinue	Info	Green
AckAlertUsbMirrorAutoPrompt	Info	Green
AckAlertUseUsbMemoryDevicePrompt	Info	Green
AckAlertBluetoothPairingPassKey	Info	Green
AckAlertInvalidZplTemplateFile	Error	Red
AckAlertCoreDumpPresent	Info	Green
AckAlertInvalidComplianceFile	Error	Red
AckAlertHeadElementTestFailed	Error	Red
AckAlertUsbPowerError	Error	Red
AckAlertFileSystemWriteError	Error	Red
AckAlertAvalancheError	Error	Red
AckAlertAvalancheTextMessage	Info	Green
AvalanchePerformingUpdate	Info	Green

Troubleshooting

Message	Type	Color
AvalancheUpdateComplete	Info	Green
BatteryHealthReplace	Warning	Yellow
BatteryHealthNearDeath	Warning	Yellow
BatteryHealthShutdown	Error	Red
BatteryAuthenticationFail	Error	Red
BatteryOverTemp	Warning	Yellow
BatteryUnderTemp	Warning	Yellow
BatteryChargeFault	Error	Red
BatteryLow	Warning	Yellow
BatteryRemoved	Warning	Yellow
BadFirmwareDownload	Error	Red
BatchCount	Info	Green
BluetoothPinInvalid	Error	Red
BluetoothPairing	Info	Green
BluetoothPairingAccepted	Info	Green
BluetoothPairingRejected	Error	Red
BluetoothPairingFailed	Error	Red
BluetoothDisplayPasskey	Info	Green
CancelAll	Info	Green
CancelOne	Info	Green
CalibrationMediaInput	Info	Green
CalibrationMediaRunning	Info	Green
CalibrationRibbonRunning	Info	Green
CalibrationRibbonInput	Info	Green
CountryCodeNotSelected	Warning	Yellow
CutError	Error	Red
DownloadingOptionBoardFirmware	Info	Green
DownloadingFirmware	Info	Green
HeadOpen	Error	Red
HeadOverTemp	Warning	Yellow
HeadUnderTemp	Warning	Yellow
HeadCold	Warning	Yellow
HeadAuthenticationFailed	Error	Red
HeadThermistorFault	Error	Red
HeadIdentificationFailed	Error	Red

Troubleshooting

Message	Type	Color
HeadMaintenanceNeeded	Info	Green
MediaLow	Info	Green
MediaOut	Error	Red
MirroringFile	Info	Green
Mirroring	Info	Green
MirroringApplication	Info	Green
MirroringCommands	Info	Green
MirroringFeedback	Info	Green
MirrorProcessingFinished	Info	Green
MotorOverTemp	Warning	Yellow
MagCardReaderActive	Info	Green
OutOfMemoryStoringGraphic	Error	Red
OutOfMemoryStoringFont	Error	Red
OutOfMemoryStoringFormat	Error	Red
OutOfMemoryStoringBitmap	Error	Red
OperationProgress	Info	Green
OptionalAlertKeyP2	Info	Green
PaperJam	Warning	Yellow
PasswordInvalid	Error	Red
PauseRequest	Warning	Yellow
PrinterError	Error	Red
PowerOff	Info	Green
PowerReset	Info	Green
PowerSleep	Info	Green
PowerSupplyError	Error	Red
PrintHeadShutdown	Warning	Yellow
ReplaceHead	Error	Red
RfidError	Error	Red
RfidNotPresent	Info	Green
RibbonOut	Error	Red
RibbonIn	Warning	Yellow
RibbonLow	Info	Green
StartingApplication	Info	Green
WlanLossSignal	Warning	Yellow
WlanResumeSignal	Info	Green

Message	Type	Color
WlanInvalidChannels	Error	Red
WlanInvalidSecurityMode	Error	Red
WmlError	Error	Red
WritingFirmwareToFlash	Info	Green

Printing a Configuration Label

1. Turn the printer off.
2. Load the media compartment with journal media (media with no black bars or gaps on the back).
3. Press and hold **FEED**, and then press and release **POWER**.
4. When printing starts, release **FEED**.

The unit:

- Prints a line of interlocking “x” characters ensuring all printhead elements work.
- Prints out the version of software loaded in the printer.
- Prints the report.

The report indicates the model, serial number, baud rate, and other detailed information on the printer’s configuration and parameter settings.

Configuration Label Example

Below are a few examples of images showcasing the configuration label printout.

Figure 32 Configuration Label Example (1/3)

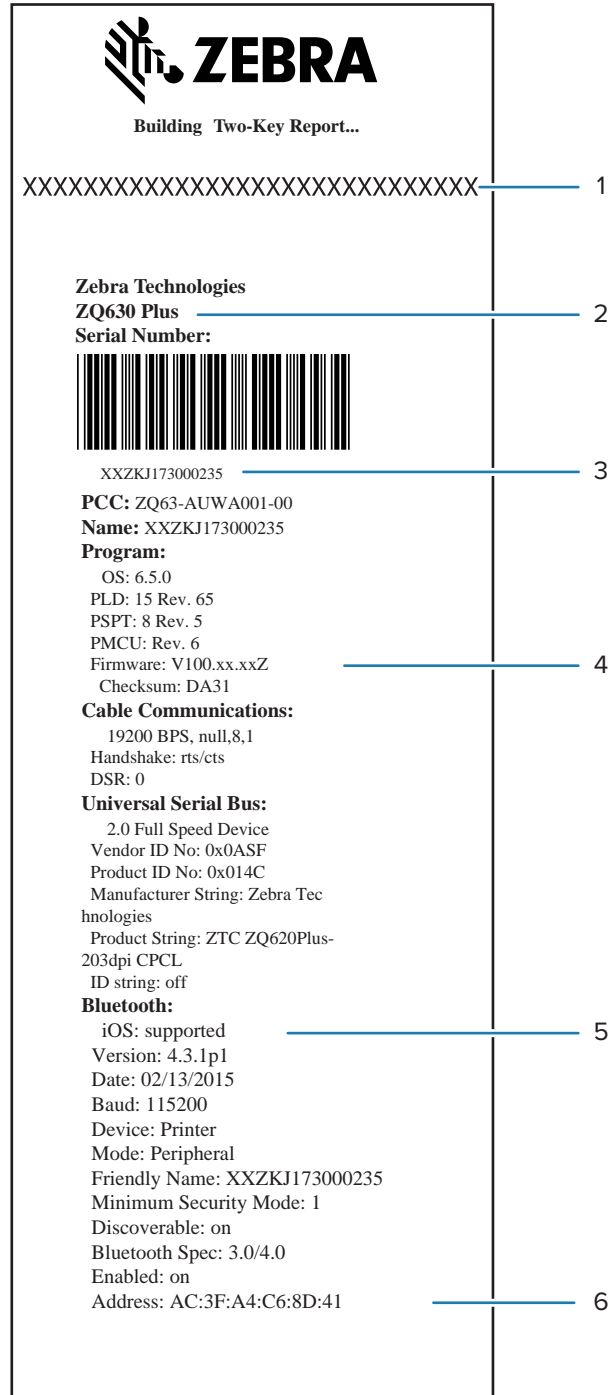
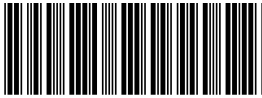

Figure 33 Configuration Labe Example (2/3)



AC3FA4C68D41

Wireless:

- Radio: 802.11 a/b/g/n/ac
- Region: usa/canada
- Country: usa/canada
- Enabled: on
- MAC Address: ac:3f:a4:C6:8D:40
- IP Address: 0.0.0.0
- Netmask: 255.255.255.0
- Gateway: 0.0.0.0
- Operating Mode: infrastructure
- International Mode: off
- Preamble Length: long
- Security: none
- Stored ESSID: 125
- Associated: no
- DHCP: on
- DHCP CID type: 1
- DHCP CID: ac3fa4c68d40
- Power Save: on

Ethernet:

- MAC Address: 00:07:4D:7A:7B:26
- IP Address: 0.0.0.0
- Netmask: 255.255.255.0
- Gateway: 0.0.0.0
- DHCP: on
- DHCP CID type: 1
- DHCP CID: 00074D7A7B26

Active Network Information:

- Active Network: Unknown
- IP Address: 0.0.0.0
- Netmask: 255.255.255.0
- Gateway: 0.0.0.0
- TCP Port: 6101
- Alternate TCP Port: 9100
- TCP JSON Config Port: 9200
- UDP Port: 6101
- Remote Server:
- Remote Server Port: 10013
- TCP: on
- UDP: on
- LPD: on
- DHCP: on
- BOOTP: on
- FTP: on
- HTTP: on
- SMTP: on
- POP3: on
- SNMP: on
- TELNET: on
- MIRROR: off
- UDP Discovery: on
- Weblink:
- DHCP CID type: 1
- DHCP CID: ac3fa4c68d40

Peripherals:

- LCD: Installed

7

8

9

10

Figure 34 Configuration Labe Example (3/3)

```

Power Management:
  In-activity Timeout:36000 Secs
  Low-battery Timeout:60 Secs
  Remote (DTR) pwr-off:Disabled
  Voltage      :8.54
  Low-bat Warning  :6.93(176)
  Low-bat Shut-down :6.53(166)
    Power On Cycles  :23
  Battery Health   :good
  Battery Cycle Count:NA
Memory:
  Flash :134217728 Bytes
  RAM   :8388608 Bytes
Label:
  Width :576 dots, 72 mm
  Height:65535 dots, 8191 mm
Sensors: (Adj)
  Pres[DAC:128,Thr:60,Cur:0]
    Label Removed
  Media [91 (576 dots)]
  Black Bar [DAC:136,Thr:70,Cur:0
]
  Gap [DAC:130,Thr:50,Cur:96]
  Temperature :27C (62)
  Voltage     :8.0V (255)
Resident Fonts:
  Font  Sizes Chars
  -----
  0     0-6  20-FF
  1     0    20-80
  2     0-1  20-59
  4     0-7  20-FF
  5     0-3  20-FF
  6     0    20-44
  7     0-1  20-FF
File Directory:
  File      Size
  -----
  E:2KEY.TXT      3507
  E:TT0003M_.TTF 169188
  134044672 Bytes Free
Command Language:
  CCL Key '!'[21]
ZPL Configuration Information:
  Rewind.....Print Mode
  Mark.....Media Type
  30.0.....Darkness
  +00.....Tear Off Adjust
  2030.....Label Length
  72mm.....Print Width
  7Eh.....Control Prefix
  2Ch.....Delimiter
  00.....Top Position
  No Motion..Media Power Up
  Feed...Media Head Closed
  00.....Left Margin
  576.....Dots per row
  End ZPL Configuration
  Print-head test: OK
  End of report

Press FEED key to
enter DUMP mode

```

11

12

13

14



15

1	Printhead test
2	Device name
3	Printer serial number
4	Firmware version
5	MFI support
6	Bluetooth radio address
7	802.11 option installed
8	Ethernet information
9	Network information
10	Peripherals installed
11	Flash and RAM memory installed
12	Maximum label size
13	Resident human-readable fonts
14	Files loaded in printer memory (includes pre-scaled or scalable fonts)
15	CPCL and ZPL programming languages supported

Troubleshooting Issues

This section provides information for troubleshooting the printers.

Issue	Recommended Solution
No power	<ul style="list-style-type: none"> • Check that the battery is installed properly. • Recharge or replace the battery as necessary.
Media does not feed	<ul style="list-style-type: none"> • Ensure that the media cover is closed and latched. • Check the spindle holding media for any binding. • Ensure the most recently printed label is removed (only in Peel mode). • Ensure the label sensor is not blocked.
Poor or faded print	<ul style="list-style-type: none"> • Clean the printhead. • Check the quality of media.
Partial or missing print	<ul style="list-style-type: none"> • Clean the printhead. • Check the media quality.
Garbled print	<ul style="list-style-type: none"> • Check the media alignment. • Clean printhead.

Issue	Recommended Solution
	<ul style="list-style-type: none"> • Ensure the media cover is properly closed and latched.
No print	<ul style="list-style-type: none"> • Check the baud rate. • Replace the battery. • Check the cable to the host device. • Establish RF Link and/or restore LAN associativity. • Invalid label format or command structure. Place the printer in Communications Diagnostic (Hex Dump) Mode to diagnose the problem.
Reduced battery charge life	<ul style="list-style-type: none"> • If the battery is over 1 year old, the short charge life may be due to normal aging. • Check the battery's health. • Replace the battery.
 flashing	<ul style="list-style-type: none"> • The blinking green Data icon is normal while data is being received.
 or  flashing	<ul style="list-style-type: none"> • Check that the media is loaded and that the media cover is closed and securely latched.
Communication Error	<ul style="list-style-type: none"> • Check the baud rate. • Replace the cable to the host device.
Label jam	<ul style="list-style-type: none"> • Open the head release latch and media cover. • Remove and reinstall media.
Skip labels	<ul style="list-style-type: none"> • Check media for top-of-form sense marks or label gaps. • Check that the maximum print field has not been exceeded on the label. • Ensure the bar or gap sensor is not blocked or malfunctioning.
Blank LCD screen	<ul style="list-style-type: none"> • Make sure the printer is turned on. • No application loaded or application corrupted: reload the program.
No NFC connection	<ul style="list-style-type: none"> • Ensure smartphone is positioned 7.62 cm (3 inches) or closer to the Print Touch icon on the side of the printer.

Communication Issues

If there is a problem transferring data between the computer and the printer, put the printer in Communications Diagnostics mode (also referred to as DUMP mode). The printer prints ASCII characters and its text representation (or the period '.', if not a printable character) from data received from the host computer.

To enter Communications Diagnostics Mode:

1. Print a configuration label as previously described.

At the end of the diagnostics report, the printer prints “Press FEED key to enter DUMP mode”.

2. Press **FEED**. The printer prints “Entering DUMP mode”.



NOTE: If **FEED** is not pressed within 3 seconds, the printer prints “DUMP mode not entered” and resumes normal operation.

The printer is in DUMP mode and prints the ASCII hex codes of any data sent to it and their text representation (or “.” if not a printable character).

A file with a .dmp extension containing the ASCII information is created and stored in the printer’s memory. It can be viewed, cloned, or deleted using the ZebraNet Bridge application. For more information on ZebraNet Bridge, go to zebra.com/zebranetbridge.

To terminate the Communications Diagnostics Mode and return the printer to normal operations:

1. Turn the printer off.
2. Wait 5 seconds.
3. Turn the printer on.

Specifications

This section lists general printer specifications, printing specifications, and media specifications.

Printer Specifications

This section provides printer specifications.

Parameter	ZQ610 Plus	ZQ620 Plus	ZQ630 Plus
Height	72.4 mm (2.85 in.)	76.9 mm (3.03 in.)	82.5 mm (3.25 in.)
Width	91.4 mm (3.6 in.)	117.9 mm (4.64 in.)	165.1 mm (6.5 in.)
Depth	170.9 mm (6.73 in.)	173.7 mm (6.84 in.)	186.7 mm (7.35 in.)
Weight with battery	0.6 kg (1.33 lbs)	0.73 kg (1.6 lbs)	1.113 kg (2.45 lbs)
Mounting hole spacing	58.928 mm (2.32 in.)	58.928 mm (2.32 in.)	101.6 mm (4.0 in.)
	Uses two M2.5 x 0.45 screws		
Temperature*	Operating: -20–50°C (-4–122°F)		
	Healthcare Units: 0–50°C (32–122°F)		
	Storage: -25–65°C (-13–149°F)		
	Charging: 0–40°C (32–104°F)		
Relative Humidity	Operating/Storage: 10–90% non-condensing		
Intrusion Protection (IP) Rating	IP54		

*With or without RFID option

Power Specifications

This section provides power specifications.

Specifications

Parameter	ZQ610 Plus	ZQ620 Plus	ZQ630 Plus
Battery	Smart Battery (2- or 4-cell) Lithium-Ion 3250 mAH 7.4 VDC (nominal) 2.45 Ahr min.	Smart Battery (2- or 4-cell) Lithium-Ion 3250 mAH 7.4 VDC (nominal) 2.45 Ahr min.	Smart Battery (4-cell) Lithium-Ion 6600 mAH 7.4 VDC (nominal) 6.8 Ahr min.
	4-cell Extended Smart Battery (optional)	4-cell Extended Smart Battery (optional)	

Communication Interface Specifications

This section provides communication interface specifications.

Parameter	ZQ600 Plus Series Printers
Flash Memory	512 MB*
RAM Memory	256 MB*
Standard Communications	RS-232 serial port (14 Pin serial connector) Configurable Baud rate (from 9600 to 115.2 Kbps), parity and data bits. Software (X-ON/X-OFF) or hardware (DTR/STR) communication handshake protocols.
Wireless Communication Options	<ul style="list-style-type: none"> • Wi-Fi 6 dual radio (802.11ax + Bluetooth 5.3 including Classic and BLE) • Wi-Fi 5 dual radio (802.11ac + Bluetooth 4.2 including Classic and BLE) • Bluetooth 4.2 including Classic and BLE
Real-Time Clock (RTC)	Time and date under application control. Refer to the ZPL Programming Manual for RTC commands.
Ethernet	10 or 100 mps Ethernet auto detect when docked in cradle.

* Printing a configuration label will retrieve your device's memory configuration. Go to [Printing a Configuration Label](#) on page 110 for more information.

Media Specifications

This section provides media specifications.

Parameter	ZQ610 Plus	ZQ620 Plus	ZQ630 Plus
Media Width	25.4–55.37 mm (1–2.18 in.)	25.4–79.4 mm (1–3.125 in.)	50.8–111 mm (2–4.4 in.) lined 50.8–109 mm (2–4.3 in.) linerless
Max/Min Label Length	25.4–55.37 mm (1–2.18 in.)	12.7–812.8 mm (0.5–32 in.)	12.7–812.8 mm (0.5–32 in.) maximum

Specifications

Parameter	ZQ610 Plus	ZQ620 Plus	ZQ630 Plus
Black Bar Sensor to Printhead Burnline Distance	13.46 mm (0.53 in.)	15.87 ± 0.635 mm (0.62 ± 0.025 in.)	15.87 ± 0.635 mm (0.62 ± 0.025 in.)
Media Thickness (except tag)	2.3–6.5 mils (0.05842–0.1651 mm)	2.3–6.5 mils (0.05842–0.1651 mm)	3.2–7.5 mils (0.08128–0.1905 mm)
Max Tag Thickness	2.3–5.5 mils (0.0542–0.1397 mm)	2.3–5.5 mils (0.0542–0.1397 mm)	5.5 mils (0.1397 mm) or less
Max Label Roll Outer Diameter	55.8 mm (2.2 in.)	66.8 mm (2.6 in.)	66.8 mm (2.6 in.)
Inner Core Diameters*	19 or 35.05 mm (0.75 or 1.38 in.)	19 or 35.05 mm (0.75 or 1.38 in.)	19.05 or 34.925 mm (0.75 or 1.375 in.)
Black Mark Location	Center the reflective media black marks on the media roll.		
Black Mark Dimensions	Min mark width: 12.7 mm (0.5 in.) Mark length: 3–11 mm (0.12–0.43 in.)	Min mark width: 12.7 mm (0.5 in.) Mark length: 3–11 mm (0.12–0.43 in.)	Min mark width: 12.7 mm (0.5 in.) Mark length: 2.4–11 mm (0.09–0.43 in.)

*The ZQ600 Plus Series printers support coreless media, which is 19 mm (0.75 in.) in inner diameter.



NOTE: Use Zebra brand direct thermal media that is outside wound. Media may be reflective (black mark) sensing, or transmissive (gap) sensing, diecut, continuous or linerless. For die-cut labels, use only full auto dies.

ZPL Font and Barcode Specifications and Commands

This section provides the ZPL fonts and barcodes and details their associated specifications and commands.

Font and Barcode Items	Specifications and Commands
Standard Fonts	15 bit-mapped fonts; 1 scalable font (CG Trimvirate Bold Condensed*)
Available Optional Fonts	Zebra offers font kits covering multiple languages including Simplified and Traditional Chinese, Japanese, Korean, Hebrew/Arabic, and others.
Linear Barcodes and 2D Barcodes Available	Barcode (CPCL Command) Aztec (^B0) Codabar (^BK) Codablock (^BB) Code 11 (^B1) Code 39 (^B3) Code 49 (B4)

Specifications

Font and Barcode Items	Specifications and Commands
	Code 93 (^BA) Code 128 (^BC) DataMatrix (^BX) EAN-8 (^B8) EAN-13 (^BE) GS1 DataBar Omnidirectional (^BR) Industrial 2 of 5 (^BI) Interleaved 2 of 5 (^B2) ISBT-128 (^BC) LOGMARS (^BL) Micro-PDF417 (^BF) MSI (^BM) PDF-417 (^B7) Planet Code (^B5) Plessey (^BP) Postnet (^BZ) Standard 2 of 5 (^BJ) TLC39 (^BT) UPC/EAN extensions (^BS) UPC-A (^BU) UPC-E (^B9) Maxi Code (^BD) QR Code (^BQ)
Rotational Angles	0°, 90°, 180°, and 270°

* Downloadable optional bit-mapped and scalable fonts via ZebraNet Bridge Enterprise software. For more information, go to zebra.com/zebranetbridge.

CPCL Font and Barcode Specifications and Commands

This section provides the CPCL fonts and barcodes and details their associated specifications and commands.

Font and Barcode Items	Specifications and Commands
Standard Fonts	25 bit-mapped fonts; 1 scalable font (CG Trimvirate Bold Condensed*)

Specifications

Font and Barcode Items	Specifications and Commands
Available Optional Fonts	<p>Optional International character sets: Chinese 16 x 16 (trad), 16 x 16 (simplified), 24 x 24 (simplified) Japanese 16 x 16, 24 x 24</p>
Linear Bar Codes Available	<p>Barcode (CPCL Commands) Aztec (AZTEC) Codabar (CODABAR, CODABAR 16) UCC/EAN 128 (UCCEAN128) Code 39 (39, 39C, F39, F39C) Code 93 (93) Code 128 (128) EAN 8, 13, 2 and 5 digit extensions (EAN8, EAN82, EAN85, EAN13, EAN132, and EAN135) EAN-8 Composite (EAN8) EAN-13 Composite (EAN13) Plessey (PLESSEY) Interleaved 2 of 5 (I2OF5) MSI (MSI, MSI10, MSI110) FIM/POSTNET (FIM) TLC39 (TLC39) UCC Composite A/B/C (128(Auto)) UPCA, 2 and 5 digit extensions (UPCA2 and UPCA5) UPCA Composite (UPCA) UPCE, 2 and 5 digit extensions (UPCE2 and UPCE5) UPCE Composite (UPCE) MaxiCode (MAXICODE) PDF 417 (PDF-417) Datamatrix (using ZPL emulation) (DATAMATRIX) QR Code (QR)</p>
2D Bar Codes Available	<p>RSS: RSS-14 (RSS-Subtype 1) RSS-14 Truncated (RSS-Subtype 2) RSS-14 Stacked (RSS-Subtype 3) RSS-14 Stacked Omnidirectional (RSS-Subtype 4) RSS Limited (RSS-Subtype 5) RSS Expanded (RSS-Subtype 6)</p>
Rotational Angles	0°, 90°, 180°, and 270°

* Contains UFST from Agfa Monotype Corporation. Downloadable optional bitmapped and scalable fonts via ZebraNet Bridge Enterprise software. For more information, go to zebra.com/zebranetbridge.

Communication Ports

This section provides information about communication ports on the printer.

RS-232C

This section provides information about RS-232 communication ports on the printer.

Figure 35 RS-232 Communications Port

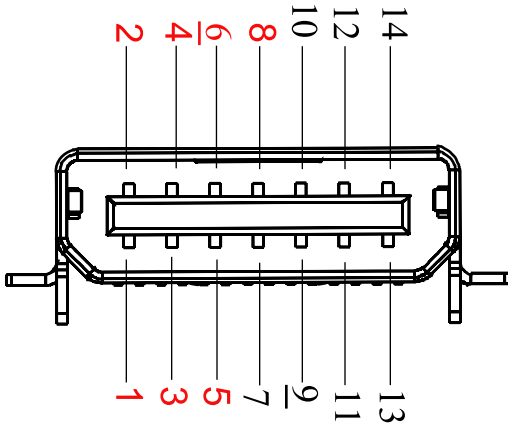

Pin #	Signal Name	Type	Description
1	CTS	input	Clear To Send from host
2	TXD	output	Transmit Data
3	RXD	input	Receive Data
4	DSR	input	Data Set Ready: low to high transition turns the printer on; high to low transition turns the printer off (if enabled).
5	GND		Ground
6	DTR	output	Data Terminal Ready: set high when the printer is on. Switched 5v (300mA max).
7	N/A		Do Not Use
8	RTS	output	Request to Send: set high when the printer is ready to accept a command or data.
9	N/A		Do Not Use
10	N/A		Do Not Use
11	N/A		Do Not Use
12	N/A		Do Not Use
13	N/A		Do Not Use
14	N/A		Do Not Use

USB

This section provides information about USB communication ports on the printer.

Figure 36 USB Communication Port

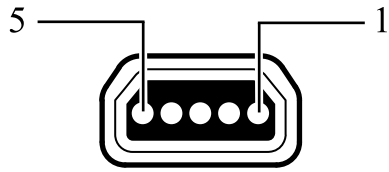

Pin #	Signal Name	Type	Description
1	VBUS	-	USB Bus Power
2	USB-	bi-directional	I/O signals
3	USB+	bi-directional	I/O signals
4	USB_ID	-	Identifies A/B connector
5	Return		Ground



NOTE: Go to zebra.com/accessories to find a comprehensive list of interface cables for all mobile printers.

