

Getting started

Operation

Printing a card

Cleaning

Troubleshooting

Specifications

Appendix A

Appendix B

Appendix C

# User's Manual

*P320 i*



Getting started

Operation

Printing a card

Cleaning

Troubleshooting

Specifications

Appendix A

Appendix B

Appendix C

## ***FOREWORD***

---

This manual contains installation and operation information for the P320i Series card printers manufactured by Zebra Technologies Corporation, Camarillo, California.

## ***RETURN MATERIALS AUTHORIZATION***

---

Before returning any equipment to Zebra Technologies Corporation for in-warranty or out-of-warranty repair, contact Repair Administration for a Return Materials Authorization (RMA) number. Repack the equipment in the original packing material and mark the RMA number clearly on the outside. Ship the equipment, freight prepaid, to the address listed below:

For USA, Latin America, Asia & Pacific:

Zebra Technologies Corporation

Eltron Card Printer Products

1001 Flynn Road

Camarillo, CA. 93012-8706. USA

Phone: +1 (805) 579 1800

Fax: +1 (805) 579 1808

Toll Free in US: (800) 452-4056

For Europe, Middle East-Africa:

Zebra Technologies Corporation

Eltron Card Printer Products

Zone Industrielle, Rue d'Amsterdam

44370 Varades, France

phone: +33 (0) 240 097 070

Fax: +33 (0) 240 834 745

## ***COPYRIGHT NOTICE***

---

This document contains information proprietary to Zebra Technologies Corporation. This document and the information contained within is copyrighted by Zebra Technologies Corporation and may not be duplicated in full or in part by any person without written approval from Zebra. While every effort has been made to keep the information contained within current and accurate as of the date of publication, no guarantee is given or implied that the document is error-free or that it is accurate with regard to any specification. Zebra reserves the right to make changes, for the purpose of product improvement, at any time.

## ***TRADEMARKS***

---

P320i is a service mark and Eltron is a registered trademark of Zebra Technologies Corporation. Windows and MS-DOS are registered trademarks of Microsoft Corp. All other marks are trademarks or registered trademarks of their respective holders.

## Getting started

## Operation

### Printing a card

## Cleaning

## Troubleshooting

## Specifications

## Appendix A

## Appendix B

## Appendix C

## **PRODUCT WARRANTY STATEMENT**

### Printers

All Eltron Card Printers are warranted against defects in material or workmanship for twelve (12) months from the purchase date.

Proof of purchase or shipment date is required to validate the warranty period. The warranty becomes void if the equipment is modified, improperly installed or used, damaged by accident or neglect, or if any parts are improperly installed or replaced by the user.

*Note: Products returned must be packaged in the original or comparable packing and shipping container. In the event equipment is not so packaged, or if shipping damage is evident, it will not be accepted for service under warranty. Surface transportation charges for return to customers in the continental United States is paid by Zebra. Otherwise, Zebra pays CPT (carriage paid to) nearest airport, customer pays customers, duties, taxes, and freight from airport to destination. If Zebra determines that the product returned for warranty service or replacement is not defective as herein defined, the customer will pay all handling and transportation costs.*

### Printheads

Since printhead wear is part of normal operation, the original printhead is covered by a twelve (12) month warranty. Warranty period begins on purchase date.

To qualify for this warranty, the printhead must be returned to the factory or to an authorized service center. Customers are not required to purchase Zebra supplies (media and/or ribbons) for warranty qualification. However, if it is determined that the use of other manufacturer supplies has caused any defect in the printhead for which a warranty claim is made, the user is responsible for Zebra's labor and material charges required to repair the defect. The warranty becomes void if the printhead is physically worn or damaged; also if it is determined that failure to follow the preventive maintenance schedule listed in the User's Guide has caused defect in the thermal printhead for which a warranty claim is made.

### Spare Parts

All parts, maintenance kits, options kits, and accessories are warranted to be free of defects in material and workmanship for 90 days (except where otherwise denoted) from date of purchase. This warranty becomes void if the item is modified, improperly installed or used, or damaged by accident or neglect.

Getting started

Operation

Printing a card

Cleaning

Troubleshooting

Specifications

Appendix A

Appendix B

Appendix C

## DECLARATIONS OF CONFORMITY



European Council Directive		Compliance to Standards	
89/336/EEC modified by 92/31/EEC and 93/68/EEC	EMC Directive	EN 55022-B	RF Emissions control
	EMC Directive	EN 500082-1,1992	Immunity to Electromagnetic Disturbances
73/23/EEC modified by 93/68/EEC	Low voltage Directive	EN 60950	Product safety



**Model:** P320i conforms to the following specification:  
**FCC Part 15, Subpart A, Section 15.107(a) and Section 15.109(a) Class B digital device**

This equipment has been tested and found to comply with the limits for a Class B digital device, pursuant to part 15 of the FCC Rules. These limits are designed to provide reasonable protection against harmful interference in a residential installation. This equipment generates, uses and can radiate radio frequency energy and, if not installed and used in accordance with the instructions, may cause harmful interference to radio communications. However, there is no guarantee that interference will not occur in a particular installation. If this equipment does cause harmful interference to radio or television reception, which can be determined by turning the equipment off and on, the user is encouraged to try to correct the interference's by one or more of the following measures:

- Reorient or relocate the receiving antenna.
- Increase the separation between the equipment and the receiver.
- Connect the equipment into an outlet on a circuit different from that to which the receiver is connected.
- Consult the dealer or an experienced radio/TV technician for help.

The user may find the following booklet, prepared by the Federal Communications Commission, helpful:

How to identify and resolve Radio/TV Interference Problems. This booklet is available from the U.S. Government printing Office, Washington, D.C. 20402, Stock No. 004-000-00345-4.

Use of a shielded cable is required to comply within Class B limits of Part 15 of FCC Rules.

Pursuant to Part 15.21 of the FCC Rules, any changes or modifications to this equipment not expressly approved by Eltron may cause, harmful interference and void the FCC authorization to operate this equipment.

## INDUSTRY CANADA NOTICE

This device complies with Industry Canada ICS-003 class B requirements.

Getting started

Operation

Printing a card

Cleaning

Troubleshooting

Specifications

Appendix A

Appendix B

Appendix C

## INTRODUCTION

Thank you for choosing the Eltron P320i Plastic Card Printer.

These printers produce cards ideal for personalized identification, access control, visitor, membership, promotion and luggage card, badges and tags.

This manual guides you to an efficient start up and operation of your new Card Printer.

## P320i PRINTER MODELS

Eltron's Product Numbers tell the story:

Here is a quick review of Eltron's Card Printer Series numbering and lettering system to help you.

Eltron's P320i Plastic Card Printer Series employ Dye Sublimation and Resin Thermal Transfer Technologies. Model numbers include identifiers that specify options and items in the Ship-Away kits.

Please refer to the Eltron Card Printer Products Price List for available options by printer type.

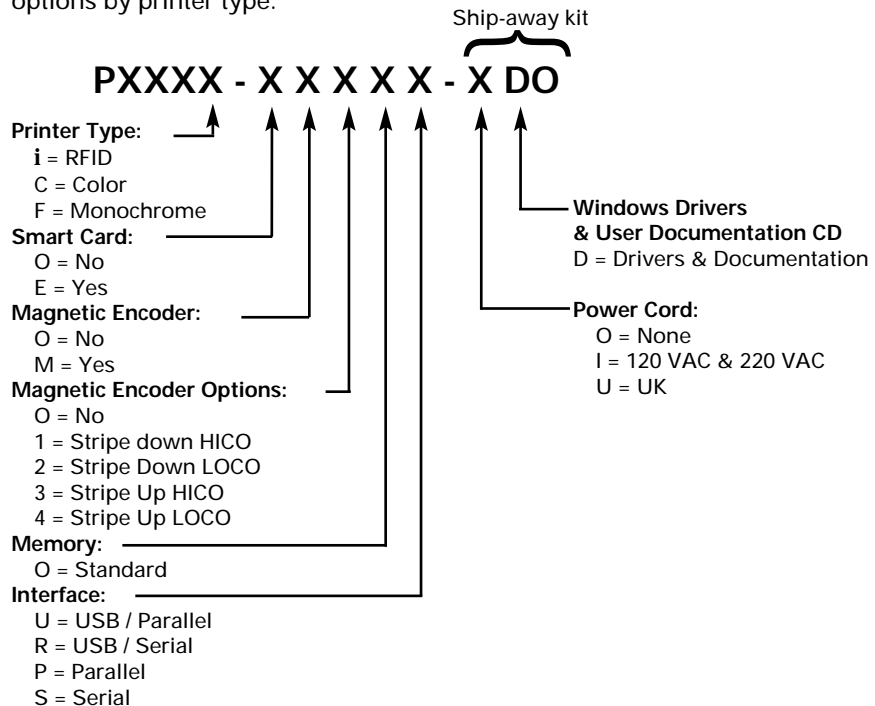

Getting started

Operation

Printing a card

Cleaning

Troubleshooting

Specifications

Appendix A

Appendix B

Appendix C

### ICONS

Throughout this manual, different icons highlight important information, as follows:



Important general information



Mechanical hazard, such as one associated with moving parts, capable of resulting in equipment damage or personal injury.



Electrical hazard, such as an exposed voltage point, capable of causing electrical shock and personal injury.



An area where electrostatic discharge (ESD) can cause component damage. Use a grounding wrist band.



Elevated temperature hazard, capable of producing a burn.



Keep Card Printer clean by minimizing cover open time.

Getting started

Operation

Printing a card

Cleaning

Troubleshooting

Specifications

Appendix A

Appendix B

Appendix C

## Table of contents

ICONS .....	vi
<hr/>	
<b>GETTING STARTED</b> .....	<b>1</b>
UNPACKING YOUR CARD PRINTER .....	1
ITEMS INCLUDED WITH YOUR PRINTER .....	2
PRINTER INSTALLATION .....	3
<hr/>	
<b>OPERATION</b> .....	<b>4</b>
P320i PRINTER FEATURES .....	4
LOADING RIBBONS .....	5
LOADING CARDS .....	7
FEEDING ONE CARD AT TIME .....	10
PRINTING A TEST CARD .....	11
<hr/>	
<b>PRINTING A SAMPLE CARD</b> .....	<b>14</b>
<hr/>	
<b>CLEANING</b> .....	<b>18</b>
CLEANING SYSTEM .....	19
CLEANING THE PRINT HEAD .....	20
CARD CLEANING CARTRIDGE .....	21
<hr/>	
<b>TROUBLESHOOTING</b> .....	<b>23</b>
<hr/>	
<b>TECHNICAL SPECIFICATIONS</b> .....	<b>29</b>
<hr/>	
<b>APPENDIX A - MAGNETIC CARD STRIP ENCODER</b> .....	<b>33</b>
<hr/>	
<b>APPENDIX B - SMART CARD CONTACT STATION</b> .....	<b>36</b>
<hr/>	
<b>APPENDIX C - ACCESSORIES AND SUPPLIES</b> .....	<b>38</b>
RIBBONS .....	38
CARDS .....	39
ACCESSORIES .....	40

Getting started

Operation

Printing a card

Cleaning

Troubleshooting

Specifications

Appendix A

Appendix B

Appendix C

## GETTING STARTED

---

### *UNPACKING YOUR CARD PRINTER*

Your P320i printer ships in a carton and protective anti-static bag. Keep all packing material in case you need to move or re-ship the printer.

While unpacking, inspect the carton to ensure that no damage occurred during shipping.

Please ensure that you have a clean and nearly dust free environment for proper operation and storage of the printer.



Getting started

Operation

Printing a card

Cleaning

Troubleshooting

Specifications

Appendix A

Appendix B

Appendix C

Make sure the following items are included with your P320i printer:

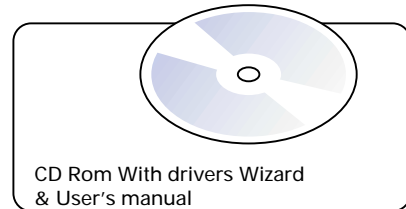
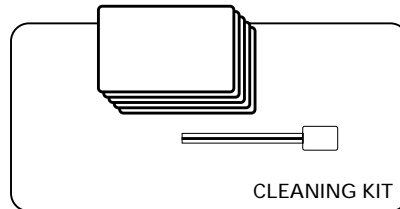
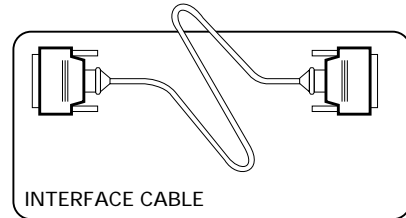
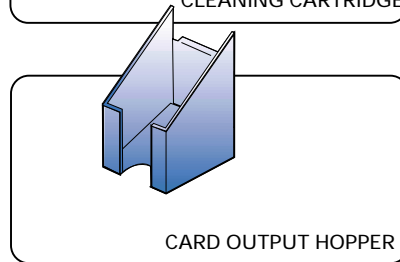
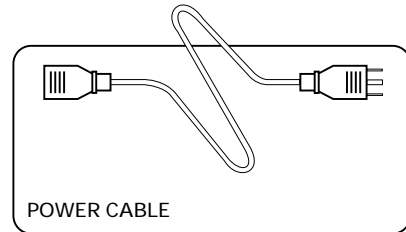
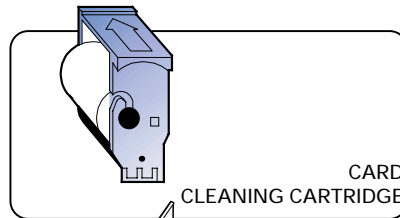

+ OPERATOR HELP GUIDE  
(Not Shown)

If any items are missing, please contact your dealer.

To reorder, please refer to Appendix C of this manual.

Getting started

Operation

Printing a card

Cleaning

Troubleshooting

Specifications

Appendix A

Appendix B

Appendix C

### PRINTER INSTALLATION

The following will guide you through the installation of your P320i Printer.



**CAUTION:** Limit AC power supplied to the P320i to 110 ~ 230 volts, 60 ~ 50 Hertz, for an associated 800 ~ 400 milliamps. Limit excess current draw to 16 amps or less, using an associated circuit breaker or other such device. Never operate the printer in a location where operator, computer, or printer can get wet. Personal injury could result. The electrical security of the printer is based on the reliability of the mains power source.

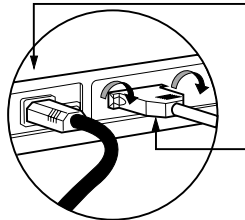
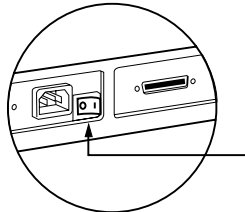
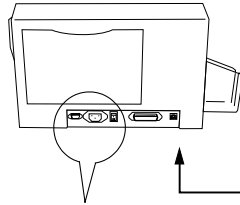

1. Place the printer in a location that allows easy access to all sides. The printer should never be operated while resting on its side or upside down.

2. Place the printer's power switch in the OFF (0) position.

3. Insert the power cable into the printer power socket and attach to grounded electrical socket of the proper voltage and type.

4. Attach interface cable to printer and computer and then secure.

5. Switch power on.



**CAUTION:** Intermittent or unpredictable operation may occur from unsecured connectors. If damaged, the power cable must be replaced by an exact equivalent.

Getting started

Operation

Printing a card

Cleaning

Troubleshooting

Specifications

Appendix A

Appendix B

Appendix C

# OPERATION

## **P 320i PRINTER FEATURES**

The following shows the features found on your P 320i Printer.

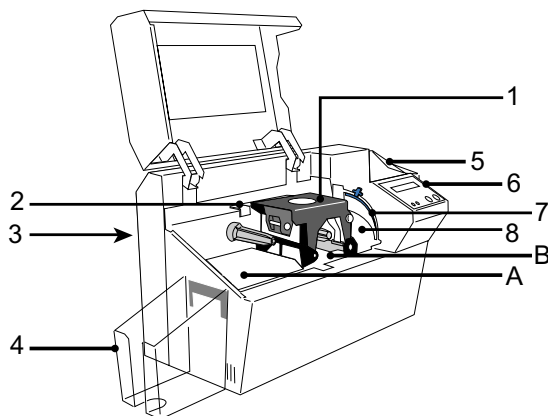

### STANDARD FEATURES

1. Print Head
2. Print Head Unlock Lever
3. Manual Holder
4. Card Output Hopper
5. Card Feeder
6. LCD Display
7. Card Thickness Control lever
8. Card Cleaning Cartridge

### OPTIONAL FEATURES

- A. Magnetic Encoding Station
- B. Smart Card Contact Station

PLEASE NOTE: Any blue items inside the printer can be operated by the user.

## **P 320i SECURITY FEATURES**

Your P 320i Plastic Card Printer comes equipped with several security features. For information on the hardware lock and key, Passcode electronic lock or the TrueSecure Varnish Image Printing, please refer to the P320i Security Features supplement document.

Contact your management or authorized dealer for more details.

Getting started

Operation

Printing a card

Cleaning

Troubleshooting

Specifications

Appendix A

Appendix B

Appendix C

### LOADING RIBBONS

i Series Printers require the use of iSeries Ribbons for full color printing (See Appendix C). The Resin Thermal Transfer, Dye Sublimation ribbons and monochrome ribbons are specifically designed for your P320i Printer. For optimum performance and printer life (Print Head), use True Colors ribbons.



DO NOT TOUCH the print head or the electronic components on the print head carriage. Discharges of electrostatic energy that accumulates on the surface of the human body or other surfaces can damage the print head and other electronic components used in the device.

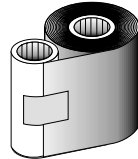

1. Remove ribbon from packaging.

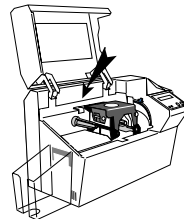

2. Open cover and press down on the print head unlock lever to open the print head carriage. The print head carriage will pop open.

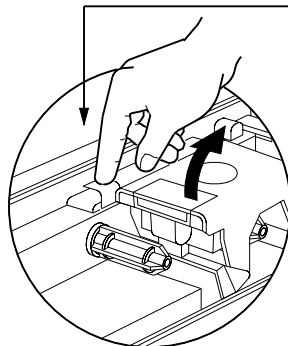

Continued on next page .....

Getting started

Operation

Printing a card

Cleaning

Troubleshooting

Specifications

Appendix A

Appendix B

Appendix C

SUPPLY SPINDLE

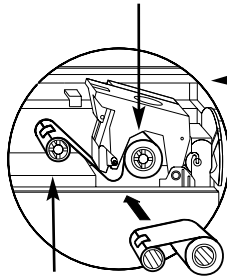

TAKE-UP SPINDLE

3. Load ribbon onto the supply spindle (under print head carriage) and empty core (with tape attached) onto the take-up spindle flange side in. Make sure the ribbon comes off of the top of the supply spindle and feeds to the top of the take-up spindle.

'CLICK'

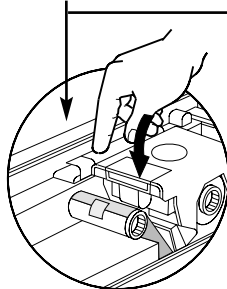

4. Push down on the Print Head Lock Lever until an audible 'click' signals the locked-down position.

5. Close Cover.



Please note that the ribbon automatically synchronizes whenever the print head lock down occurs.

The ribbon specifications will be sent to the printer and the driver parameters will automatically be set.

Getting started

Operation

Printing a card

Cleaning

Troubleshooting

Specifications

Appendix A

Appendix B

Appendix C

---

**LOADING CARDS** To help you load, print, and collect cards, the P320i is equipped with the following items:

**A - CARD CARTRIDGE**  
For loading cards.

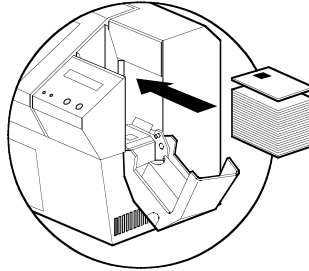

1. Open Feeder door.
2. Install cards into Cartridge.
3. Close Cartridge.



DO NOT bend cards or touch print surfaces as this can reduce print quality. The surface of the cards must remain clean and dust free. Always store cards in an enclosed container. Ideally, use cards as soon as possible. If cards stick together, carefully shuffle them.

---

\* See Chapter 6, Technical Specifications, for card requirements and capacities.

Getting started

Operation

Printing a card

Cleaning

Troubleshooting

Specifications

Appendix A

Appendix B

Appendix C

### **B - INSTALL CARD CLEANING CARTRIDGE**

*This item is used to clean the cards entering the printer.*

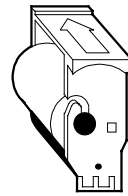

1. Remove Card Cleaning Cartridge from packaging.  
*Peel protective wrapper from adhesive roller.*

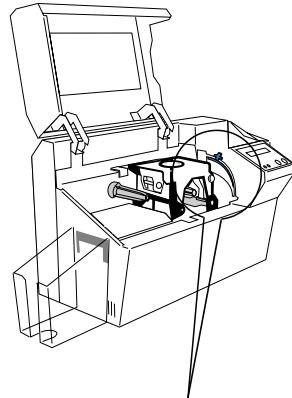

2. Open Printer cover and remove the yellow reminder tape from the location for the Cleaning Cartridge.

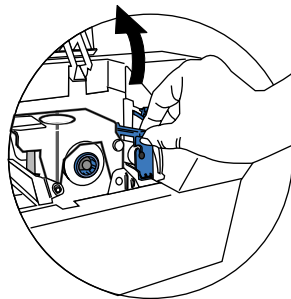

3. Make sure the arrow on top of the assembly is facing toward the rear of the printer.  
*Hook assembly into slot on printer and rotate down.*  
*Ensure the assembly locks in place.*

### Getting started

### Operation

### Printing a card

### Cleaning

### Troubleshooting

### Specifications

### Appendix A

### Appendix B

### Appendix C

#### **C - CARD THICKNESS CONTROL LEVER**

This item is operated by the user to prevent more than one card feeding into the printer at the same time and causing a jam.

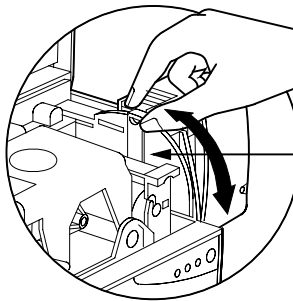

Open Cover, and adjust lever to correct position. Repeat for different card thickness. (Factory setting is for 30mil (0.762mm) card thickness. See diagram below:

#### **Card Thickness:**

- A - 60mil (1.524mm) to 50mil (1.27mm)
- B - 40mil (1.016mm)
- C - 30mil (0.762mm)

\* Start at lowest position and move lever up to match card thickness.

For other card thickness, start lever at lowest position and move up until cards feed.

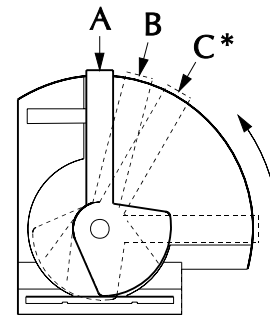

#### **D - CARD OUTPUT HOPPER**

For collecting printing cards.

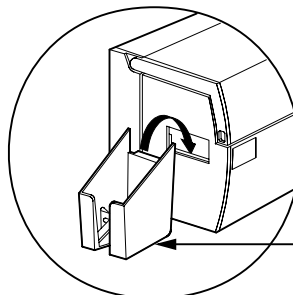

Install Card Output Hopper onto printer by hooking over bottom edge of card exit aperture.



Getting started

Operation

Printing a card

Cleaning

Troubleshooting

Specifications

Appendix A

Appendix B

Appendix C

---

### ***FEEDING ONE CARD AT A TIME***

A Manual Feed Slot is available on the side of the Card Input Hopper for feeding single cards. Cleaning Cards are fed manually through this slot. The Card Cartridge must be empty for manual card feeding to work properly.

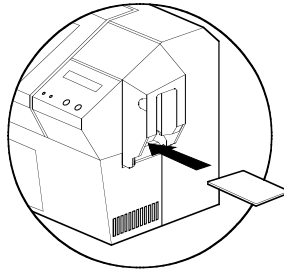

*For one-at-a-time printing, feed cards through slots on side of Feeder.*

*Do not feed more than one card at a time.*

Getting started

Operation

Printing a card

Cleaning

Troubleshooting

Specifications

Appendix A

Appendix B

Appendix C

### PRINT A TEST CARD

With ribbon and cards loaded, your P320i printer is ready to print. To check the operation of the printer you should print a test card.

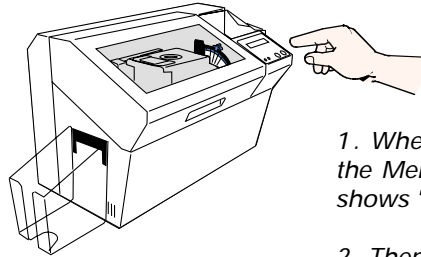

1. When the printer displays READY, press the Menu Button (Left) until the LCD screen shows "SELF TEST CARD".

2. Then press the Select Button (Right) once to "SELF TEST CARD TEST PATTERN" and once more to process.

3. A test card will print after a few seconds. LCD display will show printing status.

This is an example of the test card.



When the LCD displays "SELF TEST CARD - TEST PATTERN", press the Next button to "SELF TEST CARD - PRINT PARAMETERS", press the Select button to print a test card with the parameters.

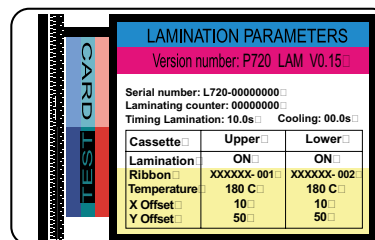

Getting started

Operation

Printing a card

Cleaning

Troubleshooting

Specifications

Appendix A

Appendix B

Appendix C

### *Printer Menu information*

The printer is equipped with a LCD Display and two key buttons which gives access to printer menus.

Press the Menu button to enter the Menu Mode.

Menu Button  
[NEXT]

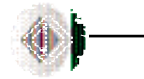
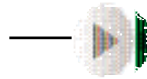

Clear Button  
[SELECT]

The top line display shows menu information. The second line of display clarifies the function of the two [NEXT] and [SELECT] key buttons relative to the current menu item.

The printer will return to READY Mode if either of the two key Buttons is not pressed within ten seconds of entering Menu mode.

[See next page:](#)

### *P320i LCD Menu Tree*

\* If the printer is equipped with a Magnetic Stripe Encoder.

## P320i Plastic Card printer

Getting started

Operation

Printing a card

Cleaning

Troubleshooting

Specifications

Appendix A

Appendix B

Appendix C

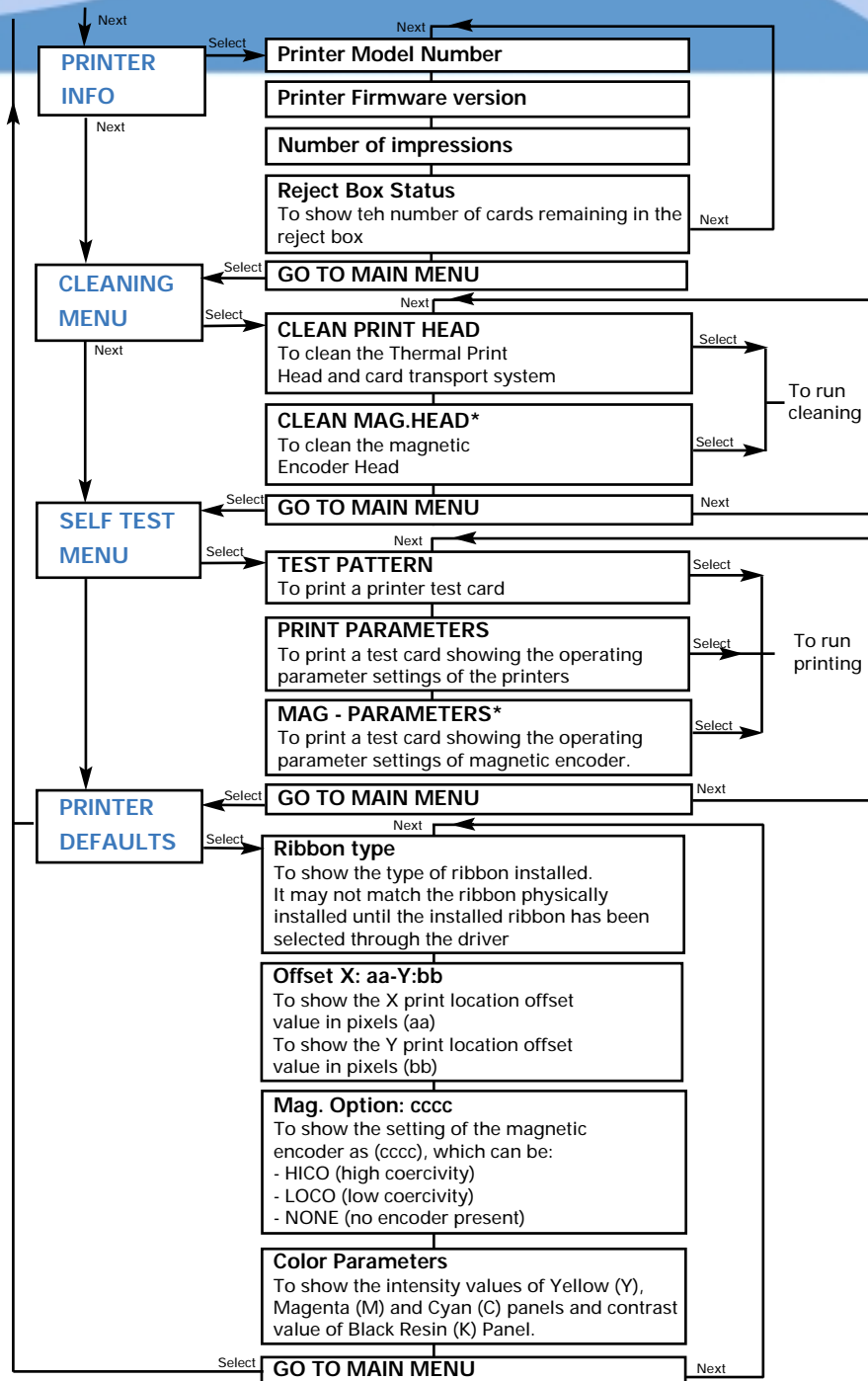

**Getting started****Operation****Printing a card****Cleaning****Troubleshooting****Specifications****Appendix A****Appendix B****Appendix C**

## ***PRINTING A SAMPLE CARD***

---

Printing with the P320i Printer requires the Windows Printer Driver, your card design/issuing software or printer command level programming through the printer interface.

The P320i Card Printer can be used with any Windows 95/98/M.E, Windows 2000 or Windows NT 4.0 software application program, using the drivers provided on CD with the printer.

This section contains information on the printing of a sample card in color (using the 5-panel color ribbon YMCKO) and the Windows Printer Driver.

Getting started

Operation

Printing a card

Cleaning

Troubleshooting

Specifications

Appendix A

Appendix B

Appendix C

To install the P320i Printer Driver Automatically on all Operating Systems, Use the Eltron Install Wizard

To ensure the accuracy of driver installation, it is recommended that you use the Eltron Install Wizard that is provided with your documentation CD.



Always make sure that USB is NOT connected before running the installer.

The Wizard will:

- a • Check to see which operating system you are using
- b • Delete previous version of the driver and clean up any necessary Registry entries
- c • From the main menu of your documentation CD, select your desired language and then select "DRIVERS" from the subsequent menu. The Install Wizard will walk you through the appropriate steps.



On NT systems, ensure that you have administrative privileges to perform this installation or contact your IT department.

**Getting started****Operation****Printing a card****Cleaning****Troubleshooting****Specifications****Appendix A****Appendix B****Appendix C**

## Set Printer Driver Options:

The P320i Printer screen appears. Change the options as follows:

- 1• On the Device Settings tab the magnetic encoder feature is automatically enabled. If you need to change settings for a Magnetic Encoder, select Magnetic Encoder settings button.
- 2• On the Advanced tab select card orientation: Landscape or portrait - Select "Landscape". (in NT, this is located under Document Defaults. In Windows 2000, it is located under Print preferences.)
- 3• In the Ribbon section, the ribbon type is automatically detected and enabled for you.
- 4• In the same tab, go to Black Panel area and select Text Only. This option allows the text printing using the Black Resin Panel from the Color Ribbon.

### Getting started

### Operation

### Printing a card

### Cleaning

### Troubleshooting

### Specifications

### Appendix A

### Appendix B

### Appendix C

## Printing a sample card:

Follow the steps to print your first card

Go to the Microsoft Word Software.

If the printer was not selected as the default printer, go to the **File** menu and Select **Printer** and choose **Eltron P320i Card Printer** in the printer names list. Then **Close** the print dialog box.

Come back to **File** menu and choose **Page Setup**.

Select **Paper Size** tab and in **Paper Size** choose **Card**. Then select the orientation: "landscape".

Go to **Margins** tab, put the Top, Bottom, Left and Right margins with 0 values.

Press **OK** to close Page Setup window.

The card appears on the screen.

Design a card with both black and colored text and with colored pictures (see example below).



Once you are ready to print, go to **File** and point **Print**

The printer will feed in a card and start printing ( the data download time will vary depending on the complexity of the card design and the processing speed of your computer).

Once the printing job is achieved the card is ejected from the printer.



Getting started

Operation

Printing a card

Cleaning

Troubleshooting

Specifications

Appendix A

Appendix B

Appendix C

## CLEANING



---

### PROTECT YOUR FACTORY WARRANTY!

The recommended maintenance procedures must be performed to maintain your factory warranty. Other than the recommended cleaning procedures described in this manual, allow only Zebra authorized technicians to service the P320i Printer. **NEVER** loosen, tighten, adjust, or bend, etc. a part or cable inside the printer. **NEVER** use a shop air compressor to remove particles in the printer.

---

Getting started

Operation

Printing a card

Cleaning

Troubleshooting

Specifications

Appendix A

Appendix B

Appendix C

### CLEANING SYSTEM

Your P320i Printer includes a simple cleaning system using the Pre-Saturated Cleaning Cards provided. The regular use of these cards will clean and maintain important parts of your printer: including the Print Head, and Transport Rollers.

#### WHEN TO CLEAN

*When LCD screen reports message.*

**CLEAN PRINTER**

#### HOW TO CLEAN

*1. Leave power on.*

*Open Cover and release Print Head Bracket to remove ribbon.*

*Close Print Head bracket.*

*Close Cover. Remove cards from Card Feeder.*

*2. Insert one Pre-Saturated Cleaning Card (provided) through slot on the side of the Card Feeder Cover.*

*3. Press the right Panel Button for a few seconds. The card will feed into printer and carry out the cleaning process. Repeat the process with a new Cleaning Card if necessary.*

*Although the CLEAN PRINTER message is displayed until the cleaning process has been performed, the printer will continue to operate.*

**Note:** *For a printer cleaning prior to the WHEN TO CLEAN signal, press the Left Panel Button until the LCD screen shows "CLEANING MENU". Press the right Panel Button to select and one more time again to run the cleaning process (Repeat first steps 1 & 2 above).*



Although the CLEAN PRINTER message is displayed until the cleaning process has been performed, the printer will continue to operate.

Getting started

Operation

Printing a card

Cleaning

Troubleshooting

Specifications

Appendix A

Appendix B

Appendix C

### ***CLEANING THE PRINT HEAD***

A cleaning using the Cleaning Cards usually suffices. However, a separate Print Head cleaning using swabs can remove more stubborn deposits when print anomalies persist. To avoid deposits, only use foam-tipped swabs.

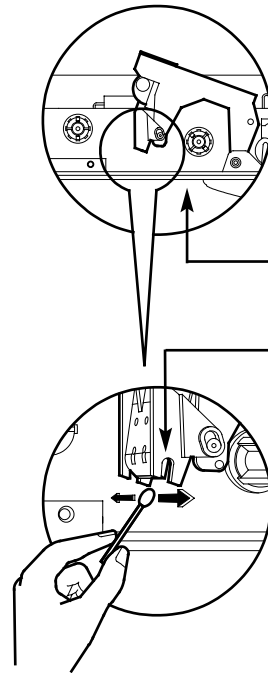

**1.** Turn power OFF. Raise Print Head and remove the Ribbon.

**2.** Clean Print Head by moving alcohol-moistened swab tip side-to-side across Print Head elements. Only use moderate force. (To reorder swabs see Appendix C).

**3.** Turn power ON. Allow two minutes for the print head components to dry before resume printing.



Never use a sharp object to scrape deposits from the print head. Permanent damage will result.

Getting started

Operation

Printing a card

Cleaning

Troubleshooting

Specifications

Appendix A

Appendix B

Appendix C

### **CARD CLEANING CARTRIDGE**

Your P320i Printer also has a Card Cleaning Cartridge. This item cleans the cards entering the printer. To ensure print quality, the cleaning roller requires periodic replacements.

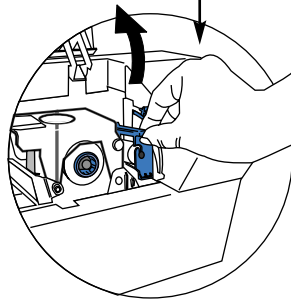
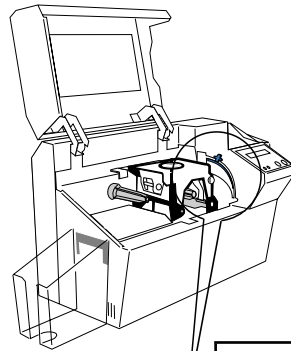

#### **WHEN TO MAINTAIN**

Replace the cleaning cartridge roller each time you install a new ribbon. A cleaning roller is included with every True Colors ribbons. If a cleaning card will be run, use the Cleaning Card before replacing Cleaning Roller.

#### **HOW TO MAINTAIN**

1. Open Cover and locate Cleaning Cartridge.
2. Gently remove by rotating up and away from printer.

Continued on next page...

### Getting started

### Operation

### Printing a card

### Cleaning

### Troubleshooting

### Specifications

### Appendix A

### Appendix B

### Appendix C

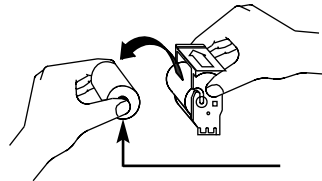

3. Remove Cleaning Roller from Cartridge and discard.

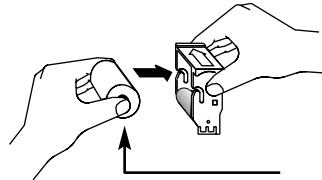

4. Install new Cleaning Roller into Cartridge\*. To avoid contamination, always hold the Cleaning Roller assembly by the ends.

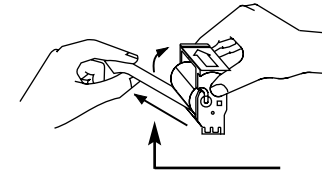

5. Carefully peel off wrapper from new Cleaning Roller while in Cartridge.

SLOT

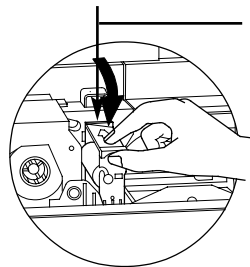

6. To replace Cartridge into printer: Make sure the arrow on top of the assembly is facing toward the rear of the printer. Hook assembly into slot on printer and rotate down. Ensure the assembly locks in place.

DO NOT touch the roller surface that contacts the card.

7. Close Cover.

\* See Appendix C for replacement Cleaning Rollers.

Getting started

Operation

Printing a card

Cleaning

Troubleshooting

Specifications

Appendix A

Appendix B

Appendix C

# TROUBLESHOOTING

This section offers solutions to potential problems you may experience with your P320i printer. The table below lists the screen messages that will be displayed on the printer's LCD, both during normal operation and to alert operator of any error conditions. There is also some additional information dealing with quality issues concerning printing onto cards.

SCREEN MESSAGE	MEANING	ACTION
INITIALIZING	The printer is performing an internal test before use	Wait for the ready message
READY	Ready for use	
WAIT TEMPERATURE	Print Head cool down mode	Wait for READY message
SELF TEST	Self test card printing	Wait for test card
DOWNLOADING DATA	The card data is being transmitted	Wait for card printing to start
PRINTING YELLOW	The yellow panel is being printed	
PRINTING MAGENTA	The magenta panel is printing	
PRINTING CYAN	The cyan panel is printing	

Getting started

Operation

Printing a card

Cleaning

Troubleshooting

Specifications

Appendix A

Appendix B

Appendix C

SCREEN MESSAGE	MEANING	ACTION
PRINTING BLACK	A monochrome panel is being printed	
PRINTING VARNISH	The overlay is printing	
PRINT HOLOGRAM	A hologram overlay is printing	
CLEAN PRINTER	The printer is prompting operator maintenance	Carry out the cleaning procedure as detailed in section 4 of this manual
CLEAN MAG HEAD	The printer is prompting operator	Carry out the cleaning procedure as detailed in Appendix A of this manual
CLEANING	The printer is performing an internal cleaning routine	
REMOVE RIBBON	The ribbon has not been removed while the cleaning operation is in progress	Remove ribbon
OUT OF RIBBON	The printer ribbon has run out	Replace printer ribbon
MECHANICAL ERROR	The printer has an error moving the card internally	Remove the jamed card. Ensure the card is not out of specification
OUT OF CARD	The card feeder is empty	Add more cards or adjust the card feeder to accept the cards
COVER OPEN	The cover is open	Close the cover
HEAD OPEN	The print head is not locked into position	Lock the print head in its lower position
COMMAND ERROR	The data being sent from the host is not recognised	Check that the data is suitable for printing. Try reprinting a card from known "good" data
PARAMETERS ERROR	The features of the card are not recognised	Check the windows driver options and printer type

Getting started

Operation

Printing a card

Cleaning

Troubleshooting

Specifications

Appendix A

Appendix B

Appendix C

SCREEN MESSAGE	MEANING	ACTION
ENCODING ERROR	Data cannot be written or read from the card's magnetic stripe	Check that the cards are loaded with the magnetic stripe in the correct orientation. Check whether high or low coercivity cards have been specified. Check that the data conforms to ISO specifications. See Appendix A of this manual for further information.
READING ERROR	Data cannot be read from the card's magnetic stripe	Check that the cards are loaded with the magnetic stripe in the correct orientation. Check whether high or low coercivity cards have been specified. Check that the data conforms to ISO specifications. See Appendix A of this manual for further information.
MAGNETIC ERROR	The printer cannot detect a magnetic stripe on the card	Check the card orientation
FLASH ERROR		Contact your dealer for technical support
NO ACCESS		

**Ribbon Errors:** Check that the print ribbon has not 'run out'. Lock and then unlock the print head assembly; this resynchronises the ribbon automatically. When using a color ribbon, it should advance automatically so that the leading edge of the Yellow panel is beneath the print head. Ensure that the correct ribbon type has been specified in the Windows driver.

**Card Feed & Mechanical Errors:** Ensure that the card thickness adjustment has been set-up correctly to allow one card to feed.

**Magnetic Encoding Errors:** Check that the cards are inserted correctly in the printer. Ensure that the cards are low or high coercivity as required, and are set-up correctly in the printer driver (Appendix A).

**Cleaning Alert:** The printer has counted the number of cards printed and has automatically flagged that a cleaning routine needs to be carried out. (See Chapter 4).



Getting started

Operation

Printing a card

Cleaning

Troubleshooting

Specifications

Appendix A

Appendix B

Appendix C

### Print Quality Issues

This section will help you resolve print quality problems. The print quality is dependent on several factors. The two most important factors that will increase your print quality are cleanliness and card stock. To diagnose and fix print quality problems, follow the troubleshooting procedure below:

• *Small spots appear on the printed card with a non-printed area or a different color.*

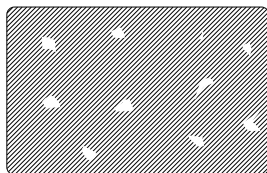

#### Possible Cause

- A. Contamination on the card surface.
- B. Dust inside the printer and/or dirty Cleaning Roller.

#### => Solution

- A1. Check that cards are stored in a dust free environment
- A2. Use a different supply of cards.
- B1. Perform a Cleaning of the printer (see Cleaning section).
- B2. Replace Cleaning Roller (see Cleaning section).

• *There are non-printing horizontal lines (white) on the card surfaces.*



#### Possible Cause

- A. Ribbons is not correctly positioned.
- B. Print Head may be dirty.
- C. Print Head elements may have been damaged (e.g. scratched or burnt).

#### => Solution

- A1. Open cover and press down the Print Head Unlock Lever to open the Print Head carriage. The Print Head will move up.
- A2. Check that the ribbon is properly rolled onto the ribbon cores and there are no wrinkles in the ribbon.
- A3. Push down on the Print Head Lock Lever until an audible «click» signals the locked-down position.
- A4. Ribbon will automatically synchronize.
- A5. Print again.
- B1. Perform a Cleaning of the Print Head (see 4.2 Cleaning the Print Head).
- C1. Call service for Print Head replacement information.

### Getting started

### Operation

### Printing a card

### Cleaning

### Troubleshooting

### Specifications

### Appendix A

### Appendix B

### Appendix C

#### • Poor Print Quality

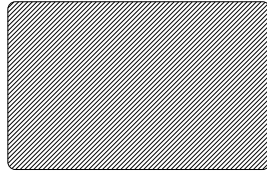

##### Possible Cause

- A. Ribbon may have been stored improperly or is damaged.
- B. Cards may not meet specifications.
- C. Contrast and/or Intensity may be set to values which are too high.
- D. Dust or embedded contamination on elements of the Print Head.

##### => Solution

- A1. Change ribbon and print again.
- B1. Use a different supply of cards.
- C1. Adjust Contrast and/or Intensity values in software
- D1. Perform a cleaning of the Print Head (see "Cleaning the Print Head")

#### • Printing is blurry



##### Possible Cause

- A. Ribbon may not be correctly positioned
- B. Ribbon may not be synchronized on the correct color panel position.
- C. Cards may not meet specifications.
- D. Dust inside the printer and/or dirty Cleaning Roller.

##### => Solution

- A1. Open cover and press down the Print Head Unlock Lever to open the Print Head carriage. The Print Head will move up.
- A2. Check ribbon is properly rolled on ribbon cores.
- A3. Push down on the Print Head Lock Lever until an audible «click» signals the locked-down position.
- A4. Ribbon will automatically synchronize.
- A5. Print again.
- B1. Open cover and press down the Print Head Unlock Lever to open the Print Head carriage. The Print Head will move up.
- B2. Push down on the Print Head Lock Lever until an audible «click» signals the locked-down position.
- B3. Ribbon will automatically synchronize.
- B4. Print again.
- C1. Use a different supply of cards.
- D1. Perform a cleaning of the Print Head (see 4.2 Cleaning the Print Head.)
- D2. Replace Cleaning Roller (see "Cleaning Cartridge")

Getting started

Operation

Printing a card

Cleaning

Troubleshooting

Specifications

Appendix A

Appendix B

Appendix C

### • No printing on the card



#### Possible Cause

- A. Ribbon may not be installed in the printer
- B. Cards may not meet specifications.
- C. Cable on Print Head may be disconnected.
- D. Print Head elements may be scratched or burnt.

#### => Solution

- A1. Check for ribbon in the printer.
- B1. Use a different supply of cards.
- C1. Power off the printer and check the Print Head cable connections.
- D1. Call Service for Print Head replacement information.



For optimum print quality, always keep cover of the printer closed except during ribbon loading and card thickness control procedures.

Getting started

Operation

Printing a card

Cleaning

Troubleshooting

Specifications

Appendix A

Appendix B

Appendix C

# TECHNICAL SPECIFICATIONS

### General

- High speed printing, over 144 cards/hour edge to edge in full color (YMCKO) throughput
- Small footprint
- Windows Drivers for 95/98 and NT 4.0, 2000
- One year printer warranty
- One year print head warranty

### Colour Printing

- Color dye sublimation or monochrome thermal transfer printing
- 25 seconds per card edge to edge in full color (YMCKO)
- 300 dpi (11.8 dots/mm) print resolution
- Edge to edge printing standard

### Bar Codes

- Code 39
- Code 128 B & C with & without check digit
- 2 of 5 & 2 of 5 industrial
- UPCA
- EAN8 & EAN13
- PDF 417 2D bar code and other symbologies available (Not resident in printer)

### Fonts

- Resident: Arial Normal 100, Arial Bold 100
- True Type fonts available via Windows Driver



i Series printers require the use of i Series Ribbons for full color printing.

Refer to the accessories section for more information about Card and Ribbon Media available from Zebra Technologies Corp.

Getting started

Operation

Printing a card

Cleaning

Troubleshooting

Specifications

Appendix A

Appendix B

Appendix C

### CARD DIMENSIONS

#### ISO STANDARD DIMENSIONS FOR PLAIN CARD

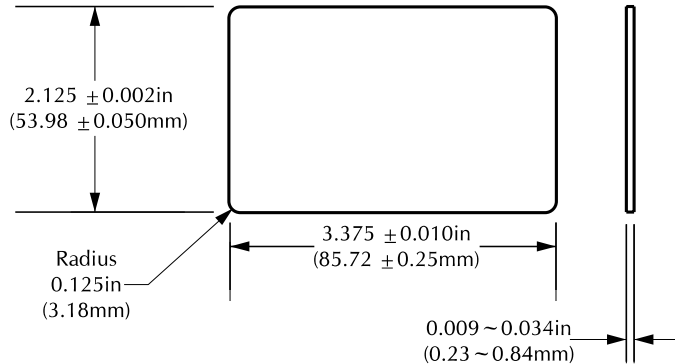

#### ISO STANDARD DIMENSIONS FOR MAGNETIC STRIPE CARD

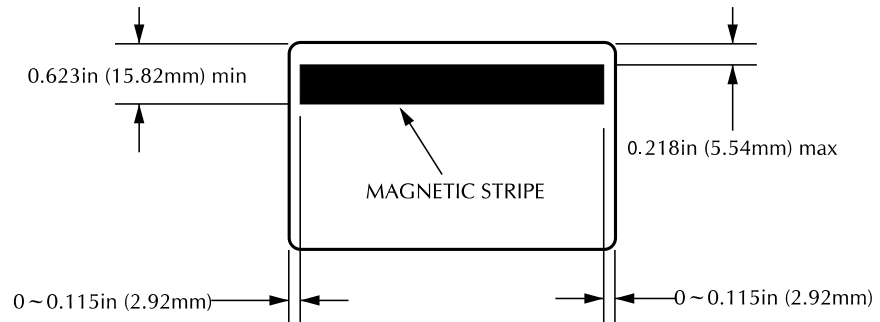

#### CHIP POSITION FOR SMART CARD

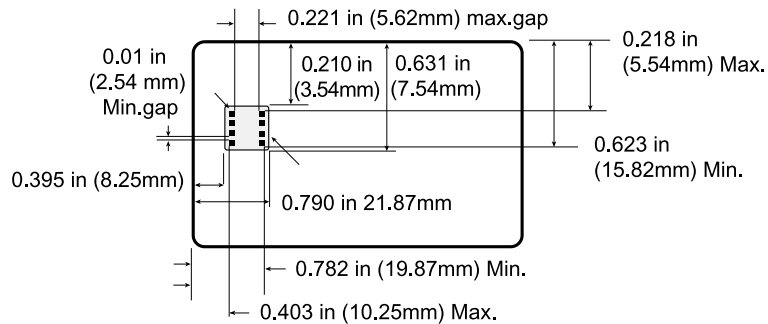

### Getting started

### Operation

### Printing a card

### Cleaning

### Troubleshooting

### Specifications

### Appendix A

### Appendix B

### Appendix C

#### *Cards\**

- Types PVC, Composite
- Card width/length: ISO CR-80 - ISO 7810, 2.125" (54mm) by 3.375" (86mm)
- Option: Magnetic Stripe - ISO 7811
- Option: Smart Card - ISO 7816-2
- Card thickness: 0.76mm to 1.524mm
- Card Feeder capacity: 100 cards (30 mil)
- Card Output Hopper capacity: 100 cards (30 mil)

#### *Ribbons\**

- Monochrome: 1000 cards/roll
- Monochrome colors: black, red, blue, green, silver, gold, white.
- K-resin + O: 500 cards/roll
- K-dye + O: 500 cards/roll
- YMCKO: 350 cards/roll

#### *Overlay varnish*

- Thermal transfer
- 4 microns thick
- Clear and holographic options:
  - Clear
  - Genuine/Secure Hologram
  - Custom Hologram

#### *Interfaces*

- Centronics Parallel Standard
- USB port (Optional)

#### *Mechanical*

- Length: 16.68" (426.35 mm†)
- Depth: 10.01" (254.31 mm†)
- Height: 10.47" (265.9 mm†)
- Weight: 23 lbs (10.43 kg)

#### *Electrical*

- 110 ~ 230 Volts AC, 60 ~ 50 Hz
- FCC Class A, CE, UL, and CUL approved

### Getting started

### Operation

### Printing a card

### Cleaning

### Troubleshooting

### Specifications

### Appendix A

### Appendix B

### Appendix C

### *Environmental*

- Operating Temperature: 60 to 86°F (15 to 30°C)
- Operating Humidity: 20 to 65% non condensing
- Storage Temperature: -23 to 158°F (-5 to 70°C)
- Storage Humidity: 20 to 70% non condensing
- Ventilation: Free air

\* Thermal transfer (Resin) ribbons offer more durability than dye sublimation, with greater resistance to scratches and UV-induced fading.

Dye Sublimation printing requires dye sublimation ribbons, with either black or cyan, magenta, and yellow (plus black resin) panels.

† Measured without card output hopper.

### *Options*

- USB port
- Smart Card Contact Station (0.76mm cards only)
- Magnetic Encoder (0.76mm cards only)
- Cleaning supplies
- Service Manual

Getting started

Operation

Printing a card

Cleaning

Troubleshooting

Specifications

Appendix A

Appendix B

Appendix C

## APPENDIX A

### Magnetic Card Stripe Encoder

This section contains information on the additional operations of the P320i Printers with Magnetic Card Stripe Encoder. (See Chapter 2 for location.)

#### INTRODUCTION

Operation and maintenance requirements for the P320i Printer with the optional magnetic card stripe encoder.  
(See Chapter 2 for location).

The magnetic encoder can be set for either high or low coercivity.



Getting started

Operation

Printing a card

Cleaning

Troubleshooting

Specifications

Appendix A

Appendix B

Appendix C

### A - MEDIA LOADING ORIENTATION

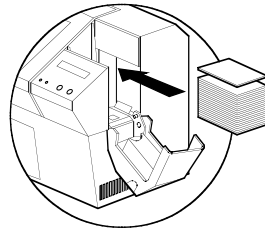

The magnetic encoder is a factory installed item with the read/write head positioned below the card path, available with HICO encoding (P320i CM1 or P320i CEM1) or LOCO encoding (P320i CM2 or P320i CEM2).

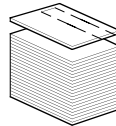

STRIPE  
DOWN

When loading cards into the Card Cartridge, please ensure that the magnetic stripe is facing down and closest to the rear.

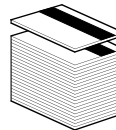

STRIPE  
UP

Also available are Printer models with the Magnetic Read/Write head positioned above the card path, with HICO encoding (P320i CM3 or P320i CEM3) or LOCO encoding (P320i CM4 or P320i CEM4).

When loading cards, please ensure that the magnetic stripe is facing up and closest to the rear.

#### NOTE:

M1 = Stripe Down HICO  
M2 = Stripe Down LOCO

M3 = Stripe up HICO  
M4 = Stripe up LOCO

Approved HICO & LOCO PVC Cards are available. (See Appendix C).



ONLY USE cards that comply with ISO 7810 & 7811 standards for magnetic stripe cards. The magnetic stripe must be flush to the surface of the card to work properly. Never use taped-on magnetic stripes.

### Getting started

### Operation

### Printing a card

### Cleaning

### Troubleshooting

### Specifications

### Appendix A

### Appendix B

### Appendix C

#### B - MAGNETIC ENCODER CLEANING

There exists two different processes to clean the Magnetic Stripe Encoder. The first process consists of a standard cleaning of the printer. This cleans the most important parts of the printer; including the Print head, Transport Roller and Magnetic Stripe Encoder (refer to chapter 4 "Cleaning" for more instructions).

The second process consists of a cleaning of the Magnetic Encoder using the Menu Button from the LCD Display.

To access the Magnetic Encoder Cleaning Menu proceed as below:

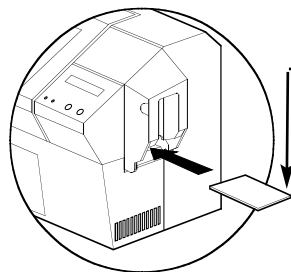

1. Leave power on.
2. Remove cards from the Card Feeder
3. Insert one Pre-Saturated Cleaning Card (provided) through slot on the side of the Card Cartridge.
4. Press the Menu button until the LCD screen shows CLEANING MENU.
5. Press the Select button to select.
6. Press the Menu button again until the LCD screen shows CLEAN MAG HEAD.
7. Run this operation by pressing the Select button.

#### ISO STANDARD ENCODING

Track #	Field Separator	Track density	Valid Characters	# of characters
1	^	210 BPI*	Alphanumeric (ASCII 20-95†)	79‡
2	=	75 BPI*	Numeric (ASCII 48-62)	40‡
3	=	210 BPI*	Numeric (ASCII 48-62)	107‡

\* Bit per inch

† Except the '?' character

‡ Including Start, Stop and LCR characters. Also note that these 3 characters are automatically managed by the magnetic encoder according to the ISO Standard Norms.

NOTE: Refer to the Card Printer Programmer's Manual for complete programming information.

**Getting started****Operation****Printing a card****Cleaning****Troubleshooting****Specifications****Appendix A****Appendix B****Appendix C**

## ***APPENDIX B***

---

### ***Smart Card Contact Station***

This section contains information on the additional operations of the P320i Printers with Smart Card Contact Stations. (See Chapter 2 for location.)

#### ***INTRODUCTION***

---

Smart Cards can have a built-in microcomputer and a battery. Card Memory can store fingerprints, voice recognition patterns, medical records and other such data. The P320i printer may be equipped with an optional contact station for programming Smart Cards (ISO 7816). This printer model responds to commands that position the cards at the contact station, where the printer connects to the contacts on the Smart Cards. All other printer operations remain the same as the standard P320i model.

Getting started

Operation

Printing a card

Cleaning

Troubleshooting

Specifications

Appendix A

Appendix B

Appendix C

### A - MEDIA LOADING ORIENTATION

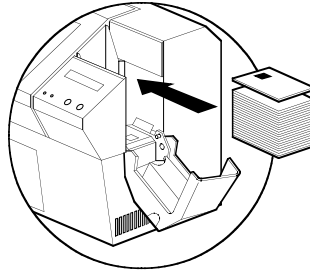

Position the cards with the Smart Card Chip at the top of the card and towards the printer.

### B - SMART CARD CONTACT STATION INTERFACE

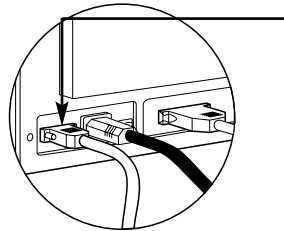

When a command to the parallel printer interface sends a card to the Smart Card Contact Station, the printer connects the Smart Card Contact Station to the female DB-9 connector on the rear of the printer.

An attached external Smart Card Programmer can be used to program Smart Card chips.

DB - 9 PINS	SMART CARD CONTACT POINTS	DB - 9 PINS	SMART CARD CONTACT POINTS
1	C1 (VCC)	6	C6 (Vpp)
2	C2 (Reset)	7	C7 (I/O)
3	C3 (Clock)	8	C8 (RFU)
4	C4 (RFU)	9	(GND when chip is at station)
5	C5 (GND)		

Refer to the Card Printer Programmer's Manual for complete programming information.



DO NOT position printing over the Smart Card Chip.

Getting started

Operation

Printing a card

Cleaning

Troubleshooting

Specifications

Appendix A

Appendix B

Appendix C

## APPENDIX C

### Accessories & supplies

Please contact your Eltron dealer to place an order for accessories and supplies.

#### RIBBONS

The following ribbons may be used in the P320i Printer:

Monochrome Resin Ribbons (Sold by the Roll)		
Part Number	Description	
800015-401	Black	1000 images
800015-402	Red	1000 images
800015-403	Green	1000 images
800015-404	Blue	1000 images
800015-406	Gold	1000 images
800015-407	Silver	1000 images
800015-409	White	1000 images
800015-485	Scratch-off Grey	800 images

Color Ribbons (Sold by the Roll)		
Part Number	Description	
800015-440	5-Panel Color Ribbon (YMCKO)	200 images
800015-540	5-Panel Color Ribbon (YMCKO)	330 images
800015-445	4-Panel Color Ribbon (YMCK)	250 images
800015-545	4-Panel Color Ribbon (YMCK)	400 images
800015-470	3-Panel Color Ribbon (YMC)	300 images
800015-450	2-Panel Black Ribbon (K Dye + O)	500 images
800015-460	2-Panel Resin Ribbon (K Resin + O)	500 images

Note: Y = Yellow, M = Magenta, C = Cyan, K = black, O = Overlay

Getting started

Operation

Printing a card

Cleaning

Troubleshooting

Specifications

Appendix A

Appendix B

Appendix C

## CARDS

The following plain white plastic cards are available for use in the P320i Printers:

*Many other card types are also available; ask your dealer for more information.*

Blank White Cards (Sold by the box)	
Part Number	Description
	<b>Premier Grade PVC</b>
104523-111	Card, 30 mil † (5 packs of 100)
104523-112	Card, 30 mil -low coercivity Mag. Stripe (5 packs of 100)
104523-113	Card, 30 mil -High coercivity Mag. Stripe (5 packs of 100)
	<b>Premier Plus Grade (PVC composite 60/40)</b>
104524-101	Card, 30 mil (5 packs of 100)
104524-102	Card, 30 mil -low coercivity Mag. Stripe (5 packs of 100)
104524-103	Card, 30 mil -High coercivity Mag. Stripe (5 packs of 100)

Getting started

Operation

Printing a card

Cleaning

Troubleshooting

Specifications

Appendix A

Appendix B

Appendix C

## ACCESSORIES

Accessories available for P320i Printers appear below. Always refer to the part number when placing an order:

Printer Supplies	
Part Number	Description
105912-212	USB Cable (6 Feet)
105912-085	Additional Card Output Hopper
105909-112	Replacement Print Head Kit

Cleaning Supplies	
Part Number	Description
105909-169	Premier Cleaning Kit (25 swabs, 50 cards)
105912-003	Adhesive Cleaning Roller Kit (set of 5)
105912-002	Cleaning Cartridge, complete
105909-055	Cleaning Card Kit (box of 100 cards)
105909-057	Cleaning Swab Kit (box of 25 swabs)

Documentation	
Part Number	Description
980081-001	Pseries Programmer's Manual (English only)
980264-001	P320i Maintenance Manual (English only)

Miscellaneous	
Part Number	Description
105576-003	CD ROM (Windows Driver Wizard, User's manuals)
806503-001	Card Punch (slots card for lapel clip)
104527-001	Lapel Clips (pack of 100 clips)

Getting started

Operation

Printing a card

Cleaning

Troubleshooting

Specifications

Appendix A

Appendix B

Appendix C

### *World Wide Sales and Support:*

**Zebra Technologies Corporation**  
**Eltron Card Printer Products**  
1001 Flynn Road  
Camarillo, CA. 93012-8706.USA  
Phone: +1 (805) 579 1800  
Fax: +1 (805) 579 1808  
Toll Free in US: (800) 452-4056  
e-mail: cards@eltron.com

**Zebra Technologies Corporation**  
**Eltron Card Printer Products, (Europe, Middle East, Africa)**  
The Valley Centre, Gordon Road, High Wycombe  
Buckinghamshire HP13 6EQ, England  
Phone: +44 (0) 870 241 1527  
Fax: +44 (0) 870 241 0765  
e-mail: eurosales@eltron.com

**Zebra Technologies Corporation**  
**Eltron Card Printer Products, France**  
50, 56 rue Marcel Dassault  
92100 Boulogne-Billancourt, France  
Phone: +33 1 55 20 93 93  
Fax: +33 1 55 20 93 99  
e-mail: frsales@eltron.com

**Zebra Technologies Corporation**  
**Eltron Card Printer Products, Latin America**  
6175 NW 153rd Street, Suite # 121  
Miami Lakes, FL 33014 USA  
Phone: +1 (305) 558 8470  
Fax: +1 (305) 558-8485  
e-mail: latinsales@eltron.com

**Zebra Technologies Corporation**  
**Eltron Card Printer Products, Asia/Pacific**  
1 Sims Lane #06-11  
387355 Singapore  
Phone: +65 84 20 322  
Fax: +65 84 20 514  
e-mail: asiasales@eltron.com

**CORPORATE HEADQUARTERS**  
Zebra Technologies Corporation  
333 Corporate Woods Parkway  
Vernon Hills, IL 60061-3109 USA  
Phone: +1 (847) 634 6700  
FAX: +1 (847) 913 8766  
e-mail: sales@Zebra.com

